

Moxa Managed Switch Next-generation OS (v4.x) Layer 2 User Manual

Version 1.4, March 2026

www.moxa.com/products

Models covered by this user's manual:

EDS-4000 Series Managed Ethernet Switches
EDS-G4000 Series Managed Ethernet Switches
MDS-G4000 Series Managed Ethernet Switches
MDS-G4000-L3 Series Managed Ethernet Switches
MDS-G4000-4XGS Series Managed Ethernet Switches
MDS-G4000-L3-4XGS Series Managed Ethernet Switches
RKS-G4000 Series Managed Ethernet Switches



© 2026 Moxa Inc. All rights reserved.

Moxa Managed Switch Next-generation OS (v4.x) Layer 2 User Manual

The software described in this manual is furnished under a license agreement and may be used only in accordance with the terms of that agreement.

Copyright Notice

© 2026 Moxa Inc. All rights reserved.

Trademarks

The MOXA logo is a registered trademark of Moxa Inc.
All other trademarks or registered marks in this manual belong to their respective manufacturers.

Disclaimer

- Information in this document is subject to change without notice and does not represent a commitment on the part of Moxa.
- Moxa provides this document as is, without warranty of any kind, either expressed or implied, including, but not limited to, its particular purpose. Moxa reserves the right to make improvements and/or changes to this manual, or to the products and/or the programs described in this manual, at any time.
- Information provided in this manual is intended to be accurate and reliable. However, Moxa assumes no responsibility for its use, or for any infringements on the rights of third parties that may result from its use.
- This product might include unintentional technical or typographical errors. Changes are periodically made to the information herein to correct such errors, and these changes are incorporated into new editions of the publication.

Technical Support Contact Information

www.moxa.com/support

Table of Contents

1. About This Manual	5
Symbols for the Meanings in the Web Interface Configurations	6
About Note, Attention, and Warning	7
Configuration Reminders	8
A: About Mandatory Parameters	8
B: Configurations before Enable/Disable	8
C. Product Series Feature Comparison Table	9
2. Getting Started	11
Log in by Web Interface	11
Connecting to the Switch	12
Log in by RS-232 Console	13
Log in by Telnet	15
3. Web Interface Configuration	18
Function Introduction	18
Device Summary	19
Model Information	19
Panel Status	20
Event Summary (Last 3 Days)	21
CPU Usage History	22
System	23
System Management	23
Account Management	36
Time	56
Port	66
Port Interface	66
Link Aggregation	70
PoE	74
Layer 2 Switching	81
VLAN	82
GARP Overview	90
MAC	91
QoS	93
Multicast	108
Network Redundancy	115
Layer 2 Redundancy	115
Management	142
Network Management	142
Security	146
Device Security	146
Management Interface	146
Network Security	155
IEEE 802.1X	155
Network Loop Protection	179
Authentication	189
Login Authentication	190
Diagnostics	195
System Status	195
Log & Event Notification	205
Diagnosis	222
Industrial Applications	241
IEC 61850	242
MMS Settings	242
Modbus TCP	247
PROFINET	248
EtherNet/IP	252
Maintenance and Tools	253
Standard/Advanced Mode	254
Disable Auto Save	254

	Reboot.....	257
	Reset to Default	258
	Log Out of the Switch.....	259
A.	Account Privileges List.....	260
	Account Privileges List.....	260
B.	Event Log Description	262
	Event Log Description.....	262
C.	SNMP MIB File	266
	Standard MIB Installation Order	266
	MIB Tree	266
D.	MODBUS Data Map and Information.....	268
	Interpretation of Moxa Switches.....	268
E.	PROFINET Attributes and TIA Portal Integration.....	276
	Addressing of I/O Data in PROFINET I/O Based on Slot and Sub-Slots.....	276
	PROFINET Attributes	276
	PROFINET Cyclic I/O Data	276
	PROFINET I/O Parameters.....	278
	Device Alarms.....	279
	Reset to Factory Mode	279
	TIA Portal Integration.....	280
	Overview of Operation Procedure.....	280
	Create a PROFINET Project in TIA Portal	280
	GSD File Installation.....	281
	Device Configuration.....	282
	Save and Load the Project into the PLC.....	284
	Monitor the Switch.....	286
F.	CIP Objects of EtherNet/IP.....	291
	Identity Object.....	291
	Message Router Object.....	292
	Assembly Object.....	293
	Connection Manager Object.....	294
	QoS Object.....	294
	Base Switch Object	295
	Port Object.....	296
	TCP/IP Interface Object	297
	Ethernet Link Object.....	299
	LLDP Management Object.....	303
	LLDP Data Table Object	304
	Moxa Networking Object (Vendor Specific).....	307
	Electronic Data Sheet (EDS) File.....	313
	Rockwell RSLogix 5000 Add-On Instructions (AOI).....	313
	AOI Installation.....	313
	CIP Tags	327
	Monitoring AOI Tags.....	332
G.	Product Code Table for Industrial Protocols.....	337
H.	Security Guidelines	339
	Installation.....	339
	Physical Installation	339
	Account Management.....	339
	Vulnerable Network Ports	340
	Operation.....	340
	Maintenance	342
	Decommission.....	342

1. About This Manual

Thank you for purchasing Moxa's managed switch. Read this user's manual to learn how to connect your Moxa switch with various interfaces and how to configure all settings and parameters via the user-friendly web interface.

This user's manual is applicable to the EDS-4000 Series, EDS-G4000 Series, MDS-G4000 Series, MDS-G4000-L3 Series, MDS-G4000-4XGS Series, MDS-G4000-L3-4XGS Series, and RKS-G4000 Series. Supported features may differ between product series. Refer to the [Product Series Feature Comparison Table](#) for more details.

Three methods can be used to connect to the Moxa's switch, which all will be described in the next two chapters. See the following descriptions for each chapter's main functions.

Chapter 2: Getting Started

In this chapter, we explain the instruction on how to initialize the configuration on Moxa's switch. We provide three interfaces to access the configuration settings: RS-232 console interface, telnet interface, and web interface.

Chapter 3: Web Interface Configuration

In this chapter, we explain how to access a Moxa switch's various configuration, monitoring, and management functions. The functions can be accessed by web browser. We describe how to configure the switch functions via web interface, which provides the most user-friendly way to configure a Moxa switch.

Appendix A: Account Privileges List

This appendix describes the read/write access privileges for different accounts on Moxa's Managed Ethernet Series switch.

Appendix B: Event Log Description



























In this appendix, users can check the event log name and its event log description. When any event occurs, this appendix helps users quickly check the detailed definition for each event.

Appendix C: SNMP MIB File

This appendix contains the SNMP MIB files so that users can manage the entities in a network with Moxa's switch.

Symbols for the Meanings in the Web Interface Configurations

The Web Interface Configuration includes various symbols. For your convenience, refer to the following table for the meanings of the symbols.

Symbols	Meanings
	Add
	Read detailed information
	Clear all
	Column selection
	Refresh
	Enable/Disable Auto Save When Auto Save is disabled, users need to click this icon to save the configurations.
	Export*
	Edit
	Re-authentication
	Delete
	Panel View
	Expand
	Collapse
	Hint Information
	Settings
	Data Comparison
	Menu icon
	Change mode
	Locator
	Reboot
	Reset to default
	Logout
	Increase
	Decrease
	Equal
	Menu
	Search

*The **Export** function helps users save the current configurations or information for the specific functions. It is located on the upper part of the configuration area. There are two formats available: **CVS**, or **PDF**. Select the format and save in your local computer.



About Note, Attention, and Warning

Throughout the whole manual, users will see some notes, attentions, and warnings. Here are the explanations for each definition.

Note: It indicates the additional explanations for the situation that users might encounter. Here is the example:



NOTE

By default, the password assigned to the Moxa switch is moxa. Be sure to change the default password after you first log in to help keep your system secure.

Attention: It indicates the situations where users might take some extra care or it might bring some problems. Here is the example:



ATTENTION

When a different type of module has been inserted into the switch, we suggest you configure the settings, or use reset-to-default.

Warning: It indicates the situations where users need to pay particular attention to, or it might bring serious damage to the system or the switch. Here is an example:



WARNING

There is a risk of explosion if the battery is replaced by an incorrect type.

Configuration Reminders

In this section, several examples will be used to remind users when configuring the settings for Moxa's switch.

A: About Mandatory Parameters

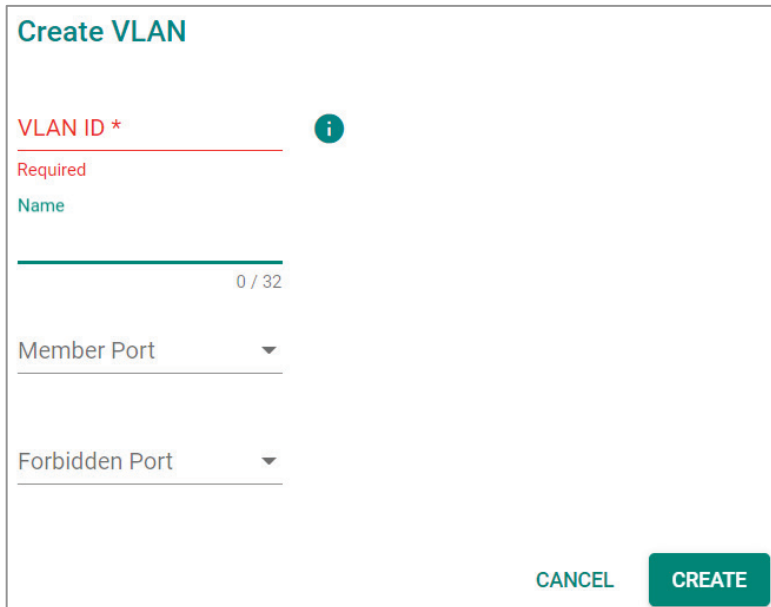

Create VLAN

VLAN ID * i

Required

Name

0 / 32

Member Port

Forbidden Port

CANCEL CREATE

1. The items with asterisks mean they are mandatory parameters that must be provided. In the figure above, the parameter for VLAN ID needs to be provided, or it will not be created or applied.
2. If the item is marked with red it means this item has been skipped. You need to fill in the parameters or you cannot apply or create the function.

In addition, some parameter values will be limited to a specific range. If the values exceed the range, it cannot be applied or created.

B: Configurations before Enable/Disable

In another situation, some settings can be configured first, but remain disabled. Users can decide to enable them when necessary without configuring the same settings again. This is particularly convenient and user-friendly when configuring various settings. For example, in Spanning Tree configuration page, users can configure the Guard settings first, but later select to disable the Guard settings in the General tab. When users decide to enable the Guard settings, they only need to select Enable in General settings, so that the Guard setting can be enabled at the same time.

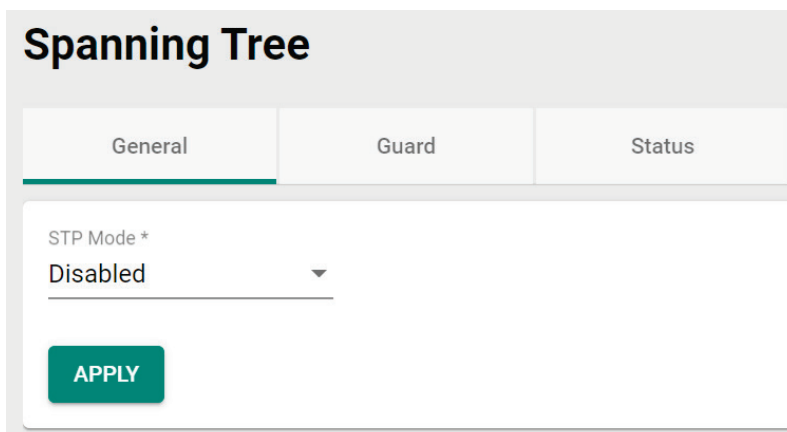

Spanning Tree

General Guard Status

STP Mode *

Disabled

APPLY

C. Product Series Feature Comparison Table

Refer to the table below for a full overview of the supported features for each product series model covered by this manual.

- ✓ Supported
- △ Partially supported
- Unsupported

For more details on partially supported features, refer to the respective feature section in this manual.

Feature			EDS-(G)4000	MDS-G4000	MDS-G4000-4XG	RKS-G4000	
Device Summary			✓	✓	✓	✓	
System	System Management	Information Settings	✓	✓	✓	✓	
		Firmware Upgrade	✓	✓	✓	✓	
		Config Back and Restore	✓	✓	✓	✓	
	Account Management	User Accounts	✓	✓	✓	✓	
		Password Policy	✓	✓	✓	✓	
		Online Accounts	✓	✓	✓	✓	
	Network	IP Configuration	✓	✓	✓	✓	
		DHCP Server	✓	✓	✓	✓	
		DHCP Relay Agent	✓	✓	✓	✓	
	Time	System Time	✓	✓	✓	✓	
		NTP Server	✓	✓	✓	✓	
		Time Synchronization	△	-	✓	✓	
Port	Port Interface	Port Settings	✓	✓	✓	✓	
		Link Delay	✓	✓	✓	✓	
	Link Aggregation	✓	✓	✓	✓		
	PoE	PoE models only					
Layer 2 Switching	VLAN		✓	✓	✓	✓	
	GARP		✓	✓	✓	✓	
	MAC	Static Unicast		✓	✓	✓	✓
		MAC Address Table		✓	✓	✓	✓
	QoS	Classification		✓	✓	✓	✓
		Ingress Rate Limit		△	✓	✓	✓
		Scheduler		✓	✓	✓	✓
		Egress Shaper		-	✓	✓	✓
	Multicast	IGMP Snooping		✓	✓	✓	✓
		GMRP		✓	✓	✓	✓
Static Multicast			✓	✓	✓	✓	
Network Redundancy	Layer 2 Redundancy	Spanning Tree	✓	✓	✓	✓	
		Turbo Ring V2	✓	✓	✓	✓	
		Turbo Chain	✓	✓	✓	✓	
		Dual Homing	✓	✓	✓	✓	
		MRP	✓	✓	✓	✓	
Management	Network Management	SNMP	✓	✓	✓	✓	

Security	Device Security	Management Interface	User Interface	✓	✓	✓	✓
			Hardware Interface	✓	✓	✓	✓
		Login Policy		✓	✓	✓	✓
		Trusted Access		✓	✓	✓	✓
		SSH & SSL		✓	✓	✓	✓
	Network Security	IEEE 802.1X		✓	✓	✓	✓
		MAC Authentication Bypass		✓	✓	✓	✓
		Port Security		✓	✓	✓	✓
		Traffic Storm Control		✓	✓	✓	✓
		Access Control List		△	✓	✓	✓
		Network Loop Protection		✓	✓	✓	✓
		Binding Database		✓	✓	✓	✓
		DHCP Snooping		✓	✓	✓	✓
		IP Source Guard		-	✓	✓	✓
		Dynamic ARP Inspection		-	✓	✓	✓
		Login Authentication		✓	✓	✓	✓
		Authentication	RADIUS		✓	✓	✓
	TACACS+			✓	✓	✓	✓
	Event Logs			✓	✓	✓	✓
	Diagnostics	System Status	Resource Utilization		✓	✓	✓
Statistics				✓	✓	✓	✓
Fiber Check				✓	✓	✓	✓
Module Information				-	✓	✓	✓
Log and Event Notifications		Event Notifications		✓	✓	✓	✓
		Syslog		✓	✓	✓	✓
		SNMP Trap/Inform		✓	✓	✓	✓
		Email Settings		✓	✓	✓	✓
		Relay Alarm Cut-off		✓	✓	✓	✓
		LLDP		✓	✓	✓	✓
Diagnosis		Port Mirroring		✓	✓	✓	✓
		Ping		✓	✓	✓	✓
		ARP Table		✓	✓	✓	✓
		MMS		✓	✓	✓	✓
Industrial Application		IEC 61850		✓	✓	✓	✓
		Modbus TCP		✓	✓	✓	✓
	PROFINET		✓	-	-	-	
	EtherNet/IP		✓	△	△	△	

2. Getting Started

In this chapter, we explain how to log in a Moxa's switch for the first time. There are three ways to access the Moxa switch's configuration settings: RS-232 console, or web-based interface.

Log in by Web Interface

You can directly connect a Moxa switch to your computer with a standard network cable or install your computer on the same intranet as your switch. You will then need to configure your computer's network settings. The default IP address for a Moxa switch is:

192.168.127.253

For example, you can configure the computer's IP setting as **192.168.127.99**, and the subnet mask as 255.255.255.0.

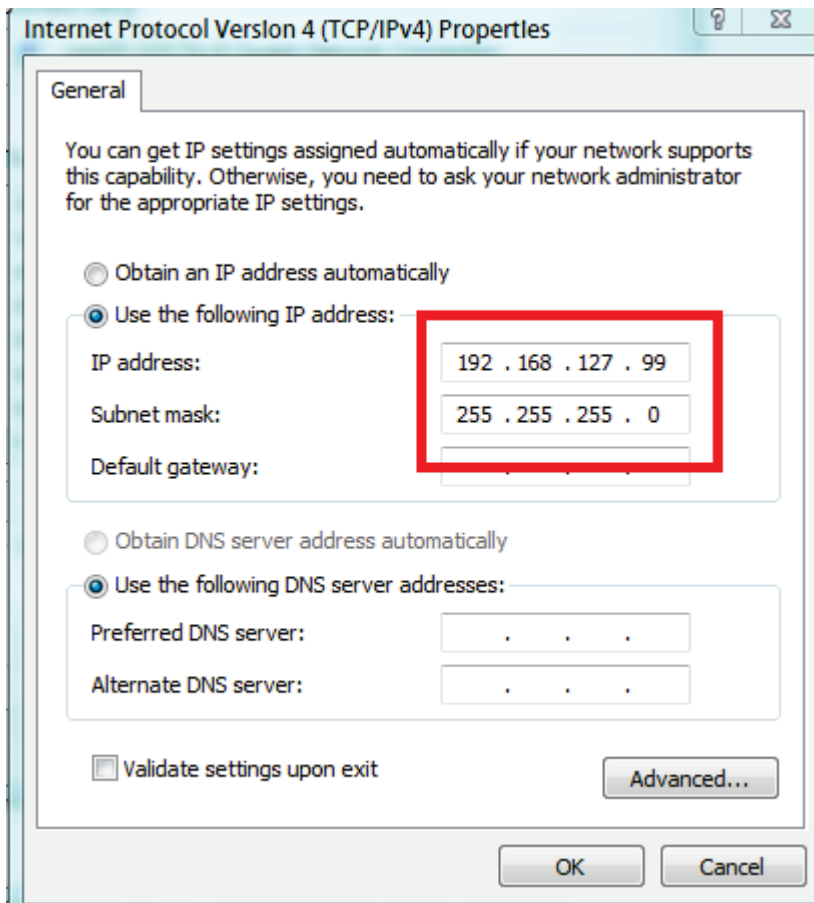

Click **OK** when finished.

Connecting to the Switch

Open a browser, such as Google Chrome, Internet Explorer 11, or Firefox, and connect to the following IP address:

https://192.168.127.253



NOTE

To enhance network security, all HTTP connections will be automatically redirected to HTTPS connections. In addition, when a web browser displays a warning message because a certificate has not been signed by a certification authority, you may add an exception rule for that certificate in the web browser or use a custom certificate to continue. Please go to the following: Security > Device Security > SSH & SSL > SSL

The default username and password are:

Username: **admin**

Password: **moxa**

Click **LOG IN** to continue. If you have logged in before, you will see a screen indicating the previous login information. Click **CLOSE**.

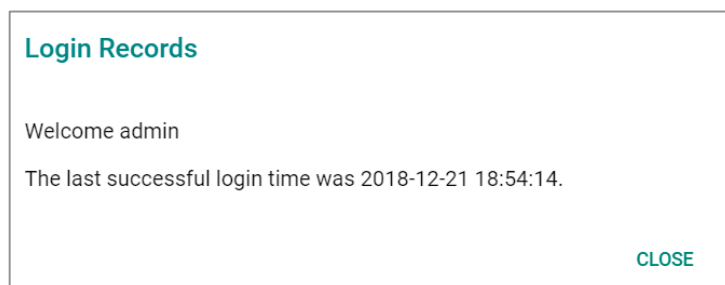

Another system message will appear, reminding you to change the default password. We recommend that you change your password, or a message will appear whenever you log in telling you to change your password. You can change the password in the **Account Management** section. Click **CLOSE** to continue.

Change Default Password

Please change the default username and password in order to enhance security.

CLOSE

Log in by RS-232 Console

The Moxa's managed switch offers a serial console port, allowing users to connect to the switch and configure the settings. Do the following steps for the serial connection and configuration.

1. Prepare an RS-232 serial cable with an RJ45 interface.
2. Connect the RJ45 interface end to the console port on the switch, and the other end to the computer.
3. We recommend you use **PComm Terminal Emulator** for serial communication. The software can be downloaded free of charge from Moxa's website.

After installing PComm Terminal Emulator, access the Moxa switch's console as follows:

4. From the Windows desktop, click **Start → Moxa → PComm Terminal Emulator**.

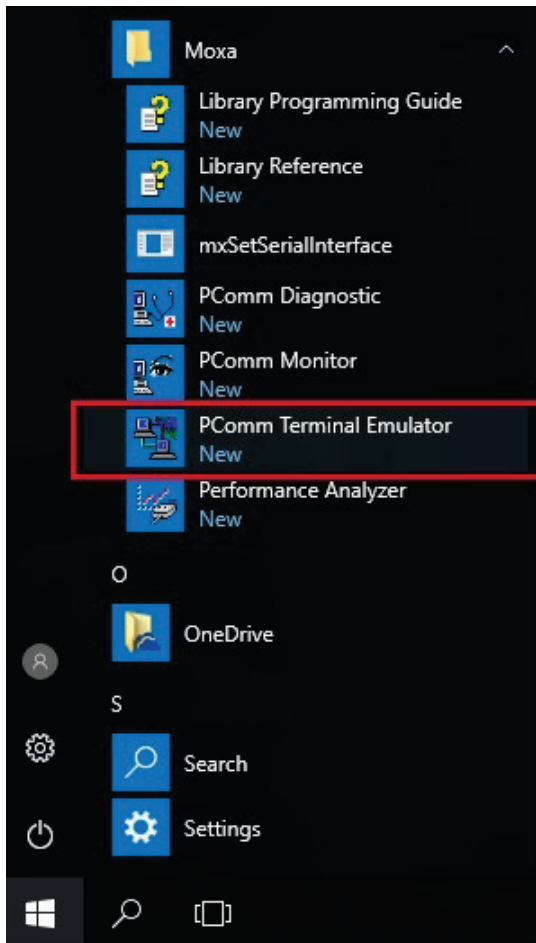

5. Select **Open** under the **Port Manager** menu to open a new connection.

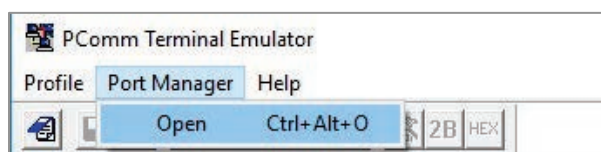

- The **Property** window should open. On the **Communication Parameter** tab for **Ports**, select the COM port that is being used for the console connection. Set the other fields as follows: **115200** for **Baud Rate**, **8** for **Data Bits**, **None** for **Parity**, and **1** for **Stop Bits**.

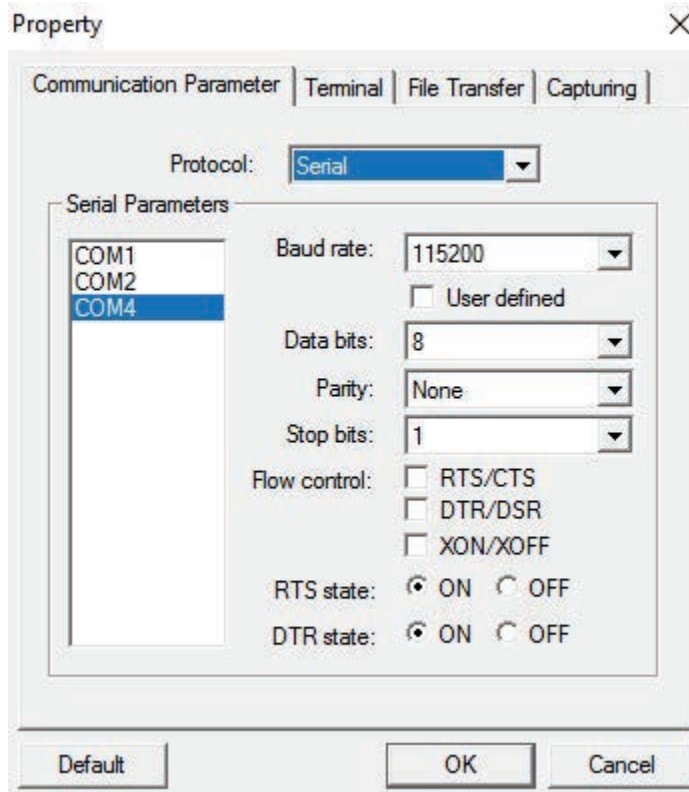

- On the **Terminal** tab, select **VT100** for **Terminal Type**, and then click **OK** to continue.

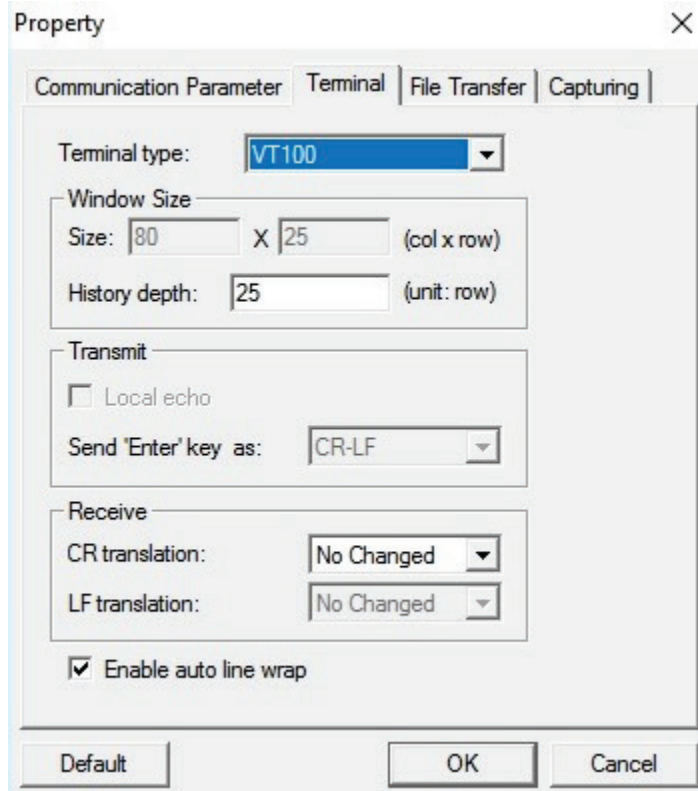

8. The console will prompt you to log in. The default login name is **admin**, and the default password is **moxa**. This password will be required to access any of the consoles (web, serial, Telnet).

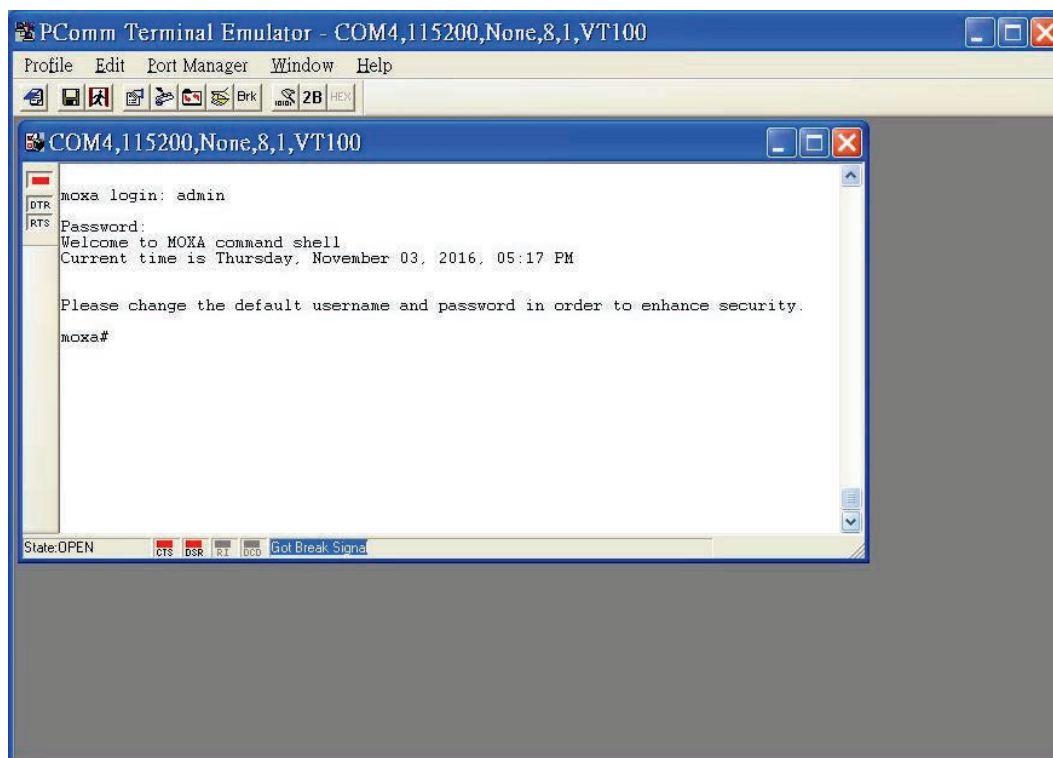

9. After successfully connecting to the switch by serial console, you can start configuring the switch's parameters by using command line instructions. Refer to the **Moxa Command Line Interface Manual** for details.



NOTE

By default, the password assigned to the Moxa switch is **moxa**. Be sure to change the default password after you first log in to help keep your system secure.

Log in by Telnet

Opening the Moxa switch's Telnet or web console over a network requires that the PC host and Moxa switch are on the same logical subnet. You might need to adjust your PC host's IP address and subnet mask. By default, the Moxa switch's IP address is 192.168.127.253 and the Moxa switch's subnet mask is 255.255.255.0. Your PC's IP address must be set to 192.168.xxx.xxx if the subnet mask is 255.255.0.0, or to 192.168.127.xxx if the subnet mask is 255.255.255.0.



NOTE

When connecting to the Moxa switch's Telnet or web console, first connect one of the Moxa switch's Ethernet ports to your Ethernet LAN, or directly to your PC's Ethernet port. You can use either a straight-through or cross-over Ethernet cable.



NOTE

The Moxa switch's default IP address is 192.168.127.253.

After making sure that the Moxa switch is connected to the same LAN and logical subnet as your PC, open the Moxa switch's Telnet console as follows:

10. Click **Start** → **Run** from the Windows Start menu and then Telnet to the Moxa switch's IP address from the Windows **Run** window. You can also issue the Telnet command from a DOS prompt.

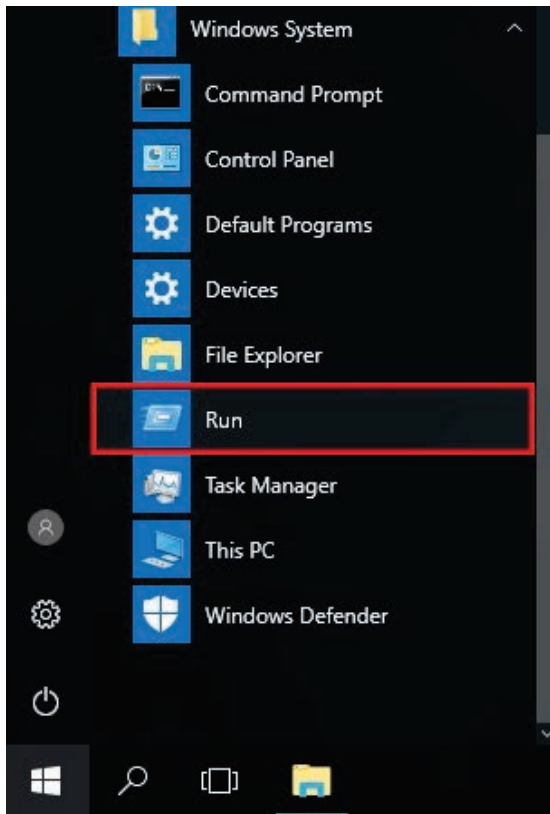

11. Next, use Telnet to connect the Moxa switch's IP address (192.168.127.253) from the Windows **Run** window. You can also issue the Telnet command from a DOS prompt.

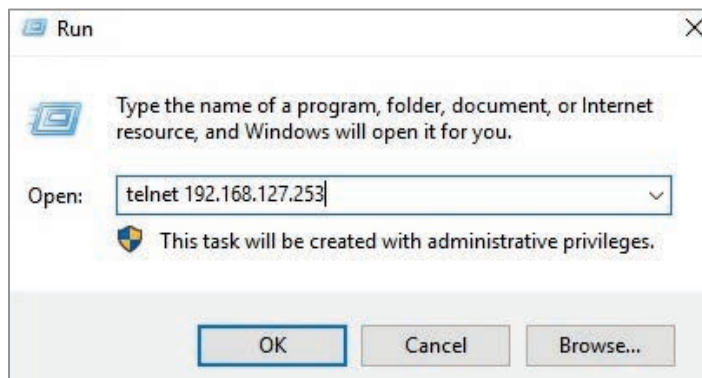

12. The Telnet console will prompt you to log in. The default login name is **admin**, and the password is **moxa**. This password will be required to access any of the consoles (web, serial, Telnet).

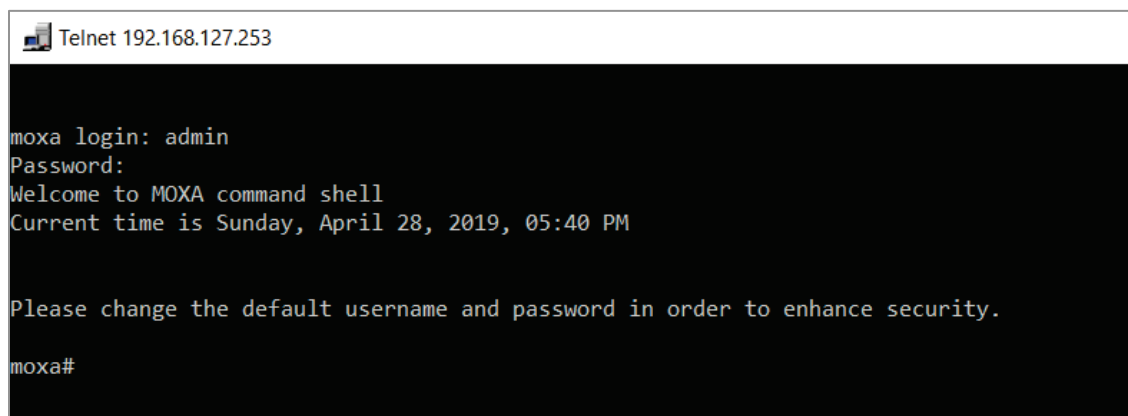

13. After successfully connecting to the switch by Telnet, users can start configuring the switch parameters by using command line instructions. Refer to the **Moxa Command Line Interface Manual**.



NOTE

By default, the password assigned to the Moxa switch is moxa. Be sure to change the default password after you first log in to help keep your system secure.

3. Web Interface Configuration

Moxa's managed switch offers a user-friendly web interface for easy configurations. Users find it simple to configure various settings over the web interface. All configurations for the Moxa's managed switch can be easily set up and done via this web interface, essentially reducing system maintenance and configuration effort.

Function Introduction

This section describes the web interface design, providing a basic visual concept for users to understand the main information or configuration menu for the web interface pages.

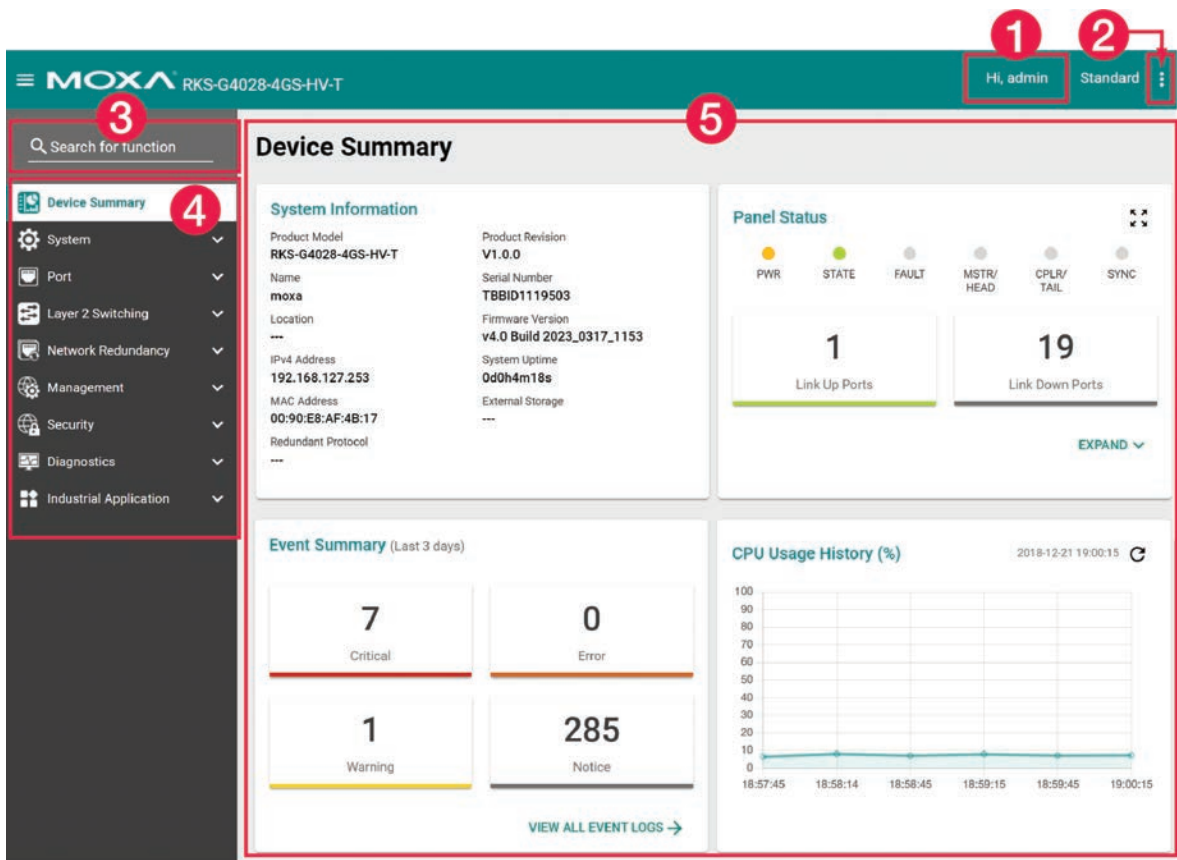

1. **Login Name:** It shows the name of user account that is logged in.
2. **Configuration Mode:** Two modes can be shown: **Standard Mode** and **Advanced Mode**.
 - **Standard Mode:** Some of the features and parameters will be hidden to make the configurations simpler (default).
 - **Advanced Mode:** More features and parameters will be shown for users to configure detailed settings.
3. **Search Bar:** Type the items you want to search of the function menu tree.
4. **Function Menu:** All functions of the switch are shown here. Click the function you want to view or configure.
5. **Device Summary:** All important device information of the functions will be shown here.

Device Summary

After successfully connecting to the switch, the **Device Summary** will automatically appear. You can view the whole web interface on the screen. If you are in the middle of performing configurations, simply click **Device Summary** on the Function Menu and you can view the detailed information of the switch.

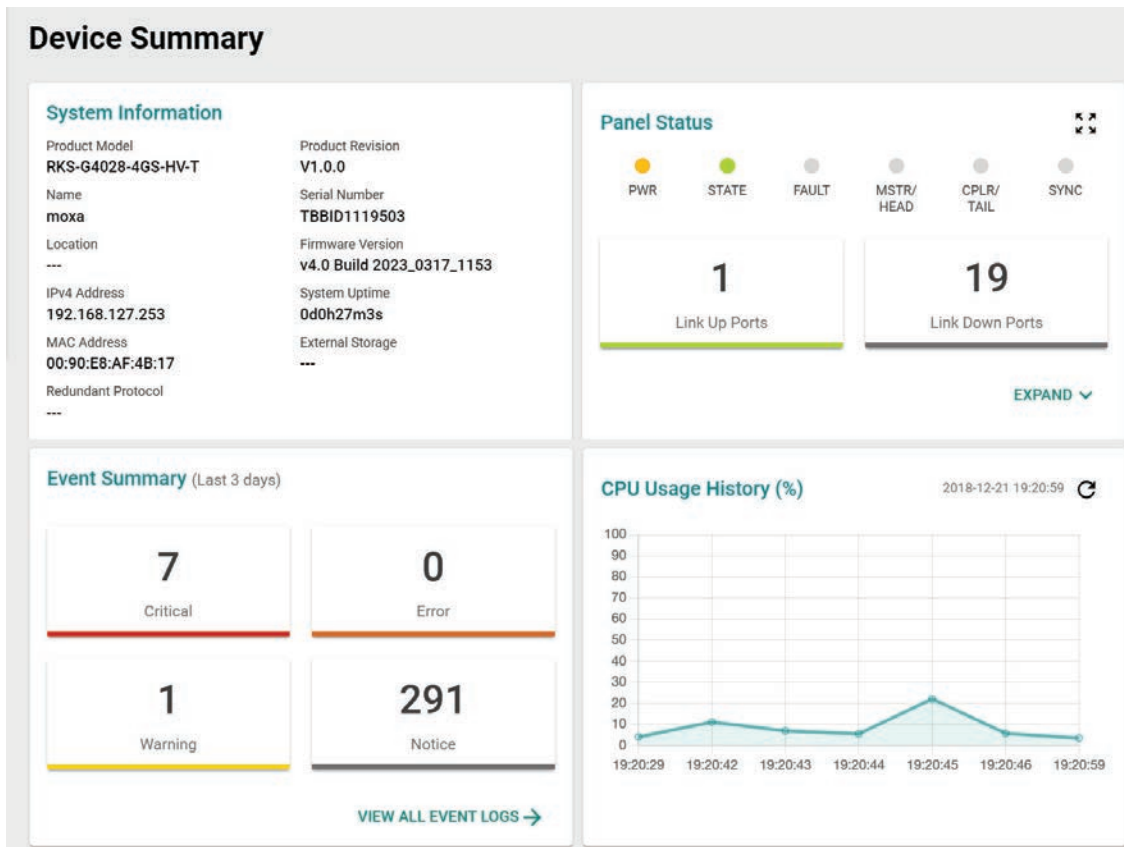

See the following sections for detailed descriptions for the specific items.

Model Information

This shows the model information, including product model name, serial number, firmware version, system uptime, etc.

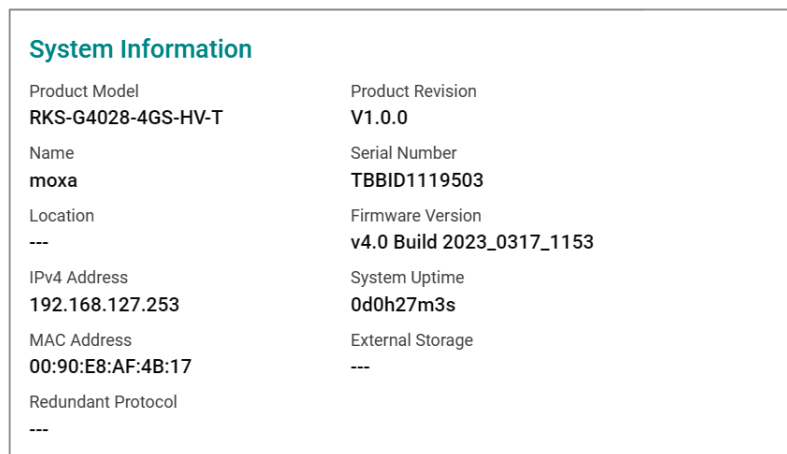

Panel Status

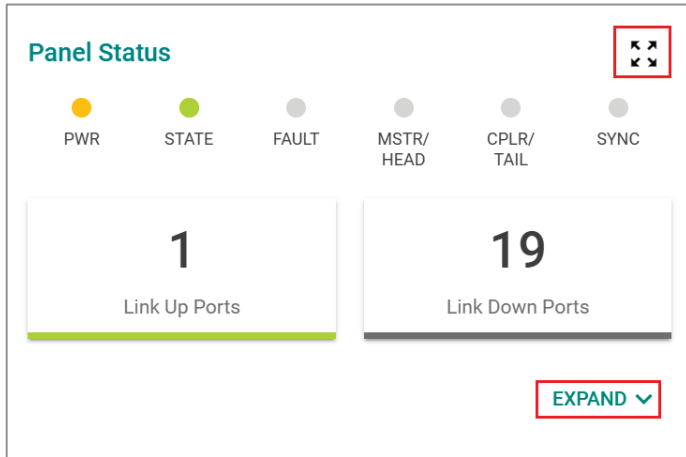

This section illustrates the panel status. For example, the connecting ports will be shown in green, while the disconnected ports will be shown in gray.

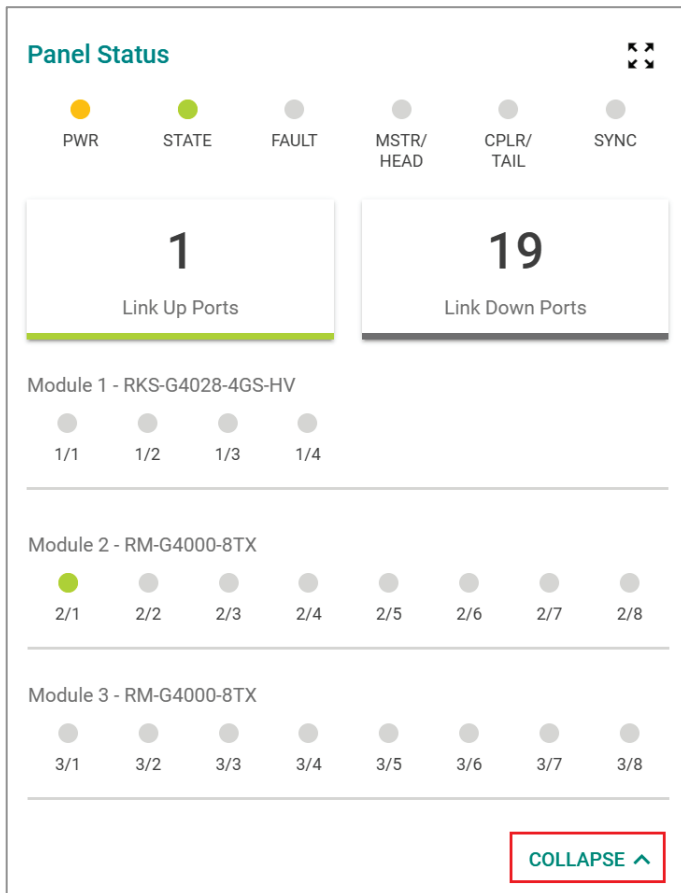

Click **Expand** to view more detailed information on the panel status and click **Collapse** to return.



Panel View

By clicking this icon, , users can view the device port status by a graphic figure. Click the  icon on the upper right corner to return to the main page.

This panel view figure might vary, depending on the different modules that you purchase.



Event Summary (Last 3 Days)

This section shows the event summary for the past three days.

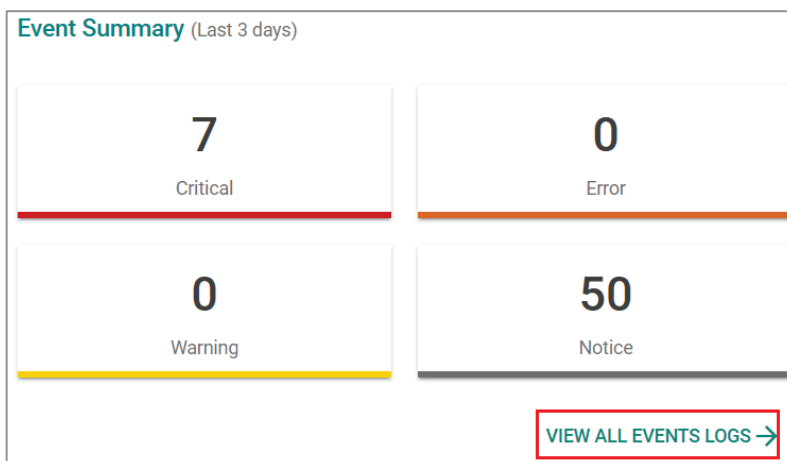

Click **VIEW ALL EVENT LOGS** to go to the Event Log page, where you can view all event logs.

Event Log

Event Log Oversize-Action Backup

🔄 🗑️ 📄 🔍 Search

Index	Bootup Number	Severity	Timestamp	Uptime	Message
1	12	Notice	2018-12-21 19:15:18	0d0h21m52s	[Account:admin] successfully logged in via local.
2	12	Notice	2018-12-21 18:59:25	0d0h5m59s	[Account:admin] logged out.
3	12	Notice	2018-12-21 18:59:06	0d0h5m40s	[Account:system] logged out.
4	12	Critical	2018-12-21 18:54:16	0d0h0m50s	System has performed a cold start.
5	12	Notice	2018-12-21 18:54:14	0d0h0m48s	[Account:admin] successfully logged in via local.
6	12	Notice	2018-12-21 18:53:59	0d0h0m33s	Interface vlan1 up.
7	12	Notice	2018-12-21 18:53:59	0d0h0m33s	Port 2/1 link up.
8	11	Notice	2018-12-21 19:18:52	0d0h25m27s	[Account:admin] logged out.

For Event Log settings, refer to **Event Log** under the **Diagnosis** section.

CPU Usage History

This section shows the CPU usage. The data will be shown as a percentage over time. Click the 🔄 icon on the page to show the latest information.

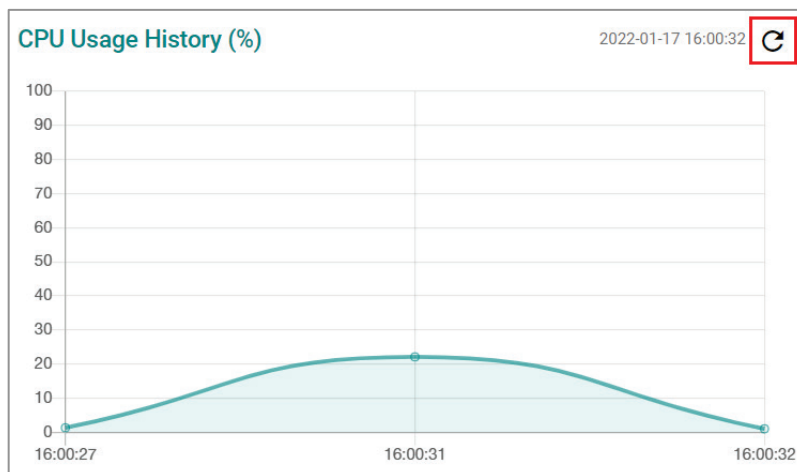

System

Click **System** on the function menu. You can configure the **System Management**, **Account Management**, **Network**, and **Time** configurations.

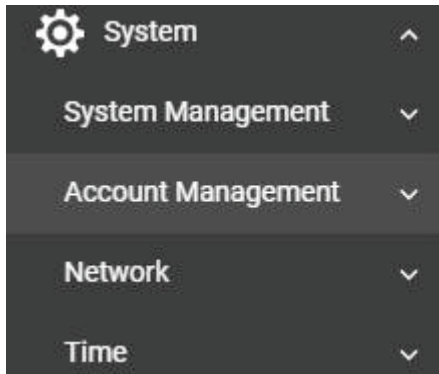

System Management

Click **System Management**, three functions can be configured under this section: **Information Setting**, **Firmware Upgrade**, and **Configure Backup and Restore**.

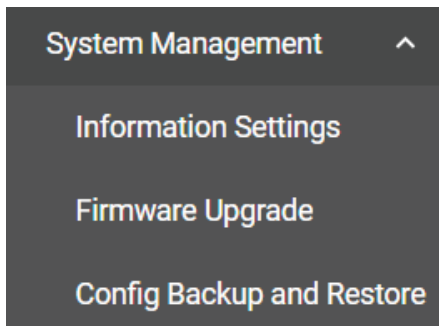

Information Setting

Define **Information Setting** items to make it easier to identify different switches that are connected to your network.

Information Settings

Device Name *

moxa

4 / 64

Location

0 / 255

Description

0 / 255

Contact Information

0 / 255

APPLY

Device Name

Setting	Description	Factory Default
1 to 64 characters	This option is useful for differentiating between the roles or applications of different units. Note that the device name cannot be empty.	moxa



NOTE

The Device Name field can only include the following characters, **a-z/A-Z/0-9/./-**. The prefix cannot start from port-x where x=0~9. The device name cannot start with-(dash) and cannot end with-(dash).

Location

Setting	Description	Factory Default
Max. 255 characters	This option is for differentiating between the locations of different switches. Example: production line 1.	None

Description

Setting	Description	Factory Default
Max. 255 characters	This option is for recording a more detailed description of the unit.	None

Contact Information

Setting	Description	Factory Default
Max. 255 characters	Users can input contact information such as email address, or telephone number when problems occur.	None



NOTE

The Device Location, Device Description, and Contact Information fields can only include the following characters, a-z/A-Z/0-9 and special characters ~ ! @ # \$ % ^ & * () { } [] < > _ + - = \ : ; , . / .

When finished, click **APPLY** to save your changes.

Firmware Upgrade

There are three ways to update your Moxa switch's firmware: from a local *.rom file, by remote SFTP server, and remote TFTP server.

Local

Select **Local** from the drop-down list under **Method**.

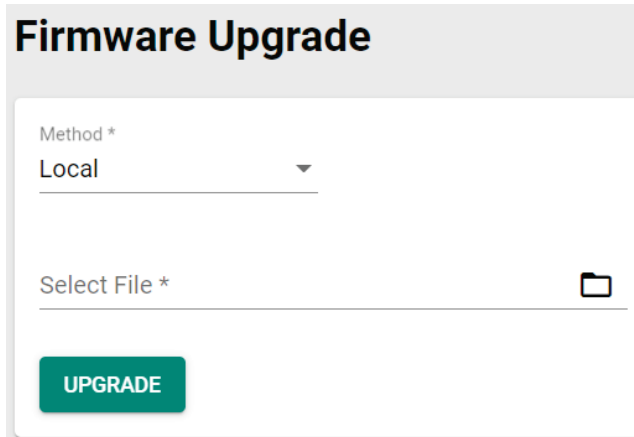

Firmware Upgrade

Method *
Local

Select File *

UPGRADE

Select File

Before performing firmware upgrade, download the updated firmware (*.rom) file first from Moxa's website (www.moxa.com).

Setting	Description	Factory Default
Select the firmware file	Select the firmware file from the location where the updated firmware is located.	None
Browse for the (*.rom) file	This option allows users to select the updated firmware file and perform the firmware upgrade.	None

When finished, click **UPGRADE** to perform the firmware upgrade.

TFTP Server

Click **TFTP** from the drop-down list under **Method**.

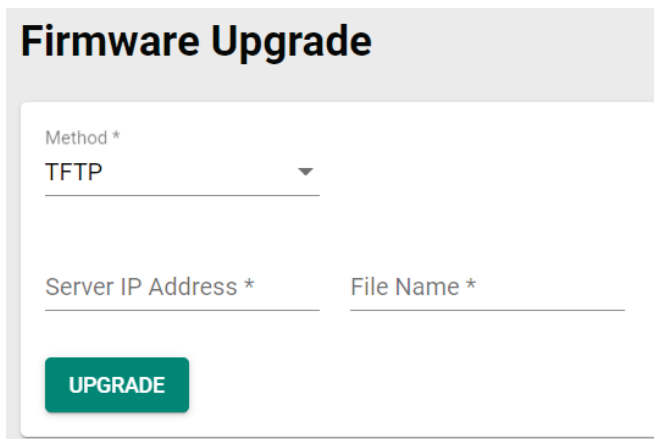

Firmware Upgrade

Method *
TFTP

Server IP Address * File Name *

UPGRADE

Server IP Address

Setting	Description	Factory Default
Input the IP address of the TFTP server	Input the IP address of the TFTP server where the new firmware file (*.rom) is located.	None

File Name

Setting	Description	Factory Default
Input the file name of the firmware	Input the file name of the new firmware.	None

When finished, click **UPGRADE** to perform the firmware upgrade.

SFTP

Select **SFTP** from the drop-down list under **Method**.

Firmware Upgrade

Method *
SFTP

Server IP Address * File Name *

Account * Password * 

UPGRADE

Server IP Address

Setting	Description	Factory Default
Input the IP address of the SFTP server.	Input the server IP address of the computer where the new firmware file (*.rom) is located.	None

File Name

Setting	Description	Factory Default
Input the file name of the firmware	Input the file name of the new firmware.	None

Account

Setting	Description	Factory Default
Input the account of the SFTP server	The account must be authorized in order for the SFTP Server to have a secure connection.	None

Password

Setting	Description	Factory Default
Input the password for the SFTP server	The password has to be specified in order to authorize the SFTP Server for secure connection.	None

When finished, click **UPGRADE** to perform the firmware upgrade. The switch will reboot automatically and perform the firmware upgrade.

External Storage

You can upgrade the firmware via Moxa's USB-based ABC-02 or microSD-based ABC-03 configuration tool. Connect the ABC-02 to the switch and select **USB** or connect the ABC-03 to the switch and select **microSD** from the drop-down list under **Method**.

Firmware Upgrade

Method *
USB 

Select File * 

UPGRADE

Firmware Upgrade

Method
microSD

Select File * 

UPGRADE

Select File

Before performing the firmware upgrade, download the latest firmware (*.rom) file first from Moxa's website (www.moxa.com).

Setting	Description	Factory Default
Select the firmware file	Select the firmware file from the location where the updated firmware is located.	None
Browse for the (*.rom) file	This option allows users to select the updated firmware file and perform the firmware upgrade.	None

When finished, click **UPGRADE** to perform the firmware upgrade.



Note

If you have difficulty using the ABC-02 or ABC-03 configuration tool, check if the **USB** Interface or **microSD** Interface has been enabled in the **Hardware Interface** section.

Configuration Backup and Restore

Backup

Click the **Backup** tab.

Configuration Backup and Restore

Backup Restore File Encryption File Signature

Method *
Local

Configuration Selection *
Running Configuration

Default Configuration *
Not Included

BACKUP

There are four ways to back up the configurations of your Moxa switch: from a local configuration file, by remote SFTP server, by remote TFTP server, or by a USB tool.

Local

Select **Local** from the drop-down list under **Method**. Configure the following settings.

Configuration Selection

Setting	Description	Factory Default
Running Configuration	Back up the running configuration.	Running
Startup Configuration	Back up the start-up configuration.	Configuration

Default Configuration

Setting	Description	Factory Default
Not Included	Back up the configuration without default settings.	Not Included
Included	Back up the configuration with default settings.	

TFTP Server

Select **TFTP** from the drop-down list under **Method**.

Configuration Backup and Restore

Backup Restore File Encryption File Signature

Method
TFTP

Server IP Address * File Name *

BACKUP

Server IP Address

Setting	Description	Factory Default
Input the IP address of the TFTP server	Users can input the IP address of the TFTP server.	None

File Name

Setting	Description	Factory Default
Input the backup file name (supports up to 54 characters, including the .ini file extension).	Users can input the file name to back up the system configuration file.	None

When finished, click **BACKUP** to back up the system configuration file.

SFTP Server

Select **SFTP** from the drop-down list under **Method**.

Configuration Backup and Restore

Backup Restore File Encryption File Signature

Method
SFTP

Server IP Address * File Name *

Account * Password * 

BACKUP

Server IP Address

Setting	Description	Factory Default
Input the IP address of the SFTP server	Input the IP address of the SFTP server where the configuration file is located.	None

File Name

Setting	Description	Factory Default
Input the backup file name (support up to 54 characters, including the .ini file extension).	Input the file name of the configuration backup file.	None

Account

Setting	Description	Factory Default
Input the account of the SFTP server	An account must be provided to authorize the SFTP server for secure connection.	None

Password

Setting	Description	Factory Default
Input the password for the SFTP server	The password has to be specified in order to authorize the SFTP Server for secure connection.	None

When finished, click **BACKUP** to back up the system configuration file.

External Storage

Select **USB** or **microSD** from the drop-down list under **Method**.

The screenshot shows the 'Configuration Backup and Restore' interface. At the top, there are four tabs: 'Backup', 'Restore', 'File Encryption', and 'File Signature'. The 'Backup' tab is selected. Below the tabs, there is a 'Method *' dropdown menu with 'USB' selected. An information icon (i) is next to the dropdown. A green 'BACKUP' button is located below the dropdown.

The screenshot shows the 'Configuration Backup and Restore' interface. At the top, there are four tabs: 'Backup', 'Restore', 'File Encryption', and 'File Signature'. The 'Backup' tab is selected. Below the tabs, there is a 'Method' dropdown menu with 'microSD' selected. A green 'BACK UP' button is located below the dropdown.

Depending on the selected method, insert a Moxa ABC-02 USB-based or ABC-03 microSD-based configuration tool into the USB port or microSD slot of the switch and click **BACKUP** to back up the system configuration file.



Note

If you have difficulty using the ABC-02 or ABC-03 configuration tool, check if the **USB** Interface or **microSD** Interface has been enabled in the **Hardware Interface** section.

Automatic Backup of Configurations

To enable automatic backup, select **Enabled** from the drop-down list. Click **APPLY** to back up the system configuration file automatically.

Auto Backup of Configurations

Automatically Back Up *

Enabled i

APPLY



Note

If **Auto Backup of Configurations** is enabled and both the ABC-02 USB-based and ABC-03 microSD-based configuration backup tools are inserted, the switch will only back up the configuration to the ABC-02 USB tool.

Restore

Click the **Restore** tab.

Configuration Backup and Restore

Backup

Restore

File Encryption

File Signature

Method *

Local v

Select File * 📁

RESTORE

There are four ways to restore the configurations of your Moxa switch: from a local configuration file, by remote SFTP server, by remote TFTP server, or by an external storage tool (USB or microSD).

Local

Select **Local** from the drop-down list under **Method**.

Select File

Setting	Description	Factory Default
Browse for a configuration file on a local disk	Select the configuration file and perform system restoration.	None

When finished, click **RESTORE** to restore the system configuration file.

TFTP Server

Select **TFTP** from the drop-down list under **Method**.

Configuration Backup and Restore

Backup	Restore	File Encryption	File Signature
Method * TFTP			
Server IP Address *		File Name *	
<input type="button" value="RESTORE"/>			

Server IP Address

Setting	Description	Factory Default
Input the IP address of the TFTP server	Users can input the IP address of the TFTP server.	None

File Name

Setting	Description	Factory Default
Input the restore file name (supports up to 54 characters, including the .ini file extension).	Users can input the file name to restore the system configuration file.	None

When finished, click **RESTORE** to restore the system configuration file.

SFTP Server

Select **SFTP** from the drop-down list under **Method**.

Configuration Backup and Restore

Backup	Restore	File Encryption	File Signature
Method SFTP			
Server IP Address *		File Name *	
Account *		Password *	
<input type="button" value="RESTORE"/>			

Server IP Address

Setting	Description	Factory Default
Input the IP address of the SFTP server	Input the IP address of the SFTP server where the configuration file is located.	None

File Name

Setting	Description	Factory Default
Input the restore file name (supports up to 54 characters, including the .ini file extension).	Input the file name of the configuration restoration file.	None

Account

Setting	Description	Factory Default
Input the account of the SFTP server	An account must be provided to authorize the SFTP server for secure connection.	None

Password

Setting	Description	Factory Default
Input the password for the SFTP server	The password has to be specified in order to authorize the SFTP Server for secure connection.	None

When finished, click **RESTORE** to restore the system configuration file.

External Storage

Select **USB** or **microSD** from the drop-down list under **Method**.

Configuration Backup and Restore

Backup	Restore	File Encryption	File Signature
--------	---------	-----------------	----------------

Method *
USB 

Select File * 

RESTORE

Configuration Backup and Restore

Backup	Restore	File Encryption	File Signature
--------	---------	-----------------	----------------

Method
microSD

Select File * 

RESTORE

Depending on the selected method, insert a Moxa ABC-02 USB-based or ABC-03 microSD-based configuration tool into the USB port or microSD slot of the switch and click **RESTORE** to restore the system configuration file.



Note

If you have difficulty using the ABC-02 or ABC-03 configuration tool, check if the **USB** Interface or **microSD** Interface has been enabled in the **Hardware Interface** section.

Auto Load of Configurations

To enable automatic configuration restore, select **Enabled** from the drop-down list. Click **APPLY** to restore the system configuration file automatically.

Auto Load of Configurations

Automatically Restore *

Enabled ▼ i

APPLY



Note

If **Auto Load of Configurations** is enabled and both the ABC-02 USB-based and ABC-03 microSD-based configuration backup tools are inserted, the switch will only restore the configuration from to the ABC-02 USB tool.

File Encryption

To encrypt the configuration file, click the **File Encryption** tab first.

Configuration Backup and Restore

Backup
Restore
File Encryption
File Signature

Configuration File Encryption *

Disabled ▼

Password 🔒

0 / 60

APPLY

Configuration File Encryption

Setting	Description	Factory Default
Enabled	Enable the configuration file to be encrypted.	
Disabled	Disable the feature that allows the configuration file to be encrypted.	Disabled

Password

Setting	Description	Factory Default
4 to 16 characters, numbers only.	Input the password when users encrypt the configuration file.	None

When finished, click **APPLY** to save your changes.

File Signature

Click **File Signature** tab to see additional configuration options. Enabling the file signature can ensure file integrity and authenticity.

Configuration Backup and Restore

Backup
Restore
File Encryption
File Signature

Signed config *
 Disabled i

APPLY

+

Key	Label	Algorithm	Length

Max. 1

Enable Signed Configuration

Setting	Description	Factory Default
Enabled	Enable configuration file signature.	Disabled
Disabled	Disable configuration file signature	

Click **APPLY** to save your changes.

Click the + icon to add a custom key.

Add Custom Key

Label *
 0 / 16

Certificate * 📁

Key * 📁

CANCEL
CREATE

Label

Setting	Description	Factory Default
0 to 16 characters	Provide the name for the certificate and the key.	None

Certificate

Setting	Description	Factory Default
Click the 📁 icon to select the file from your computer	Import the certificate file.	None

Key

Setting	Description	Factory Default
Click the  icon to select the file from your computer	Import the key file.	None

When finished, click **CREATE** to save your changes.

Account Management

The Account Management feature allows users to manage the accounts of the switch. You can enable different accounts with different roles to facilitate convenient management and safe access.

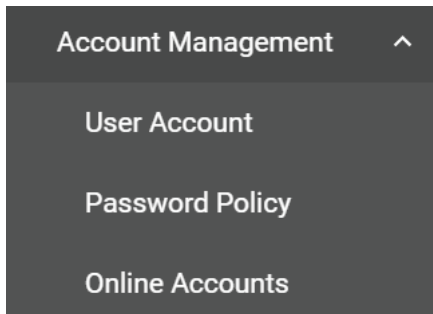

User Account

This section describes how to manage the existing accounts of the switch. Here, you can add, edit, and delete user accounts for the switch. By default, there is only one account: admin. In order to enhance security, we suggest you create a new account with the user authority.

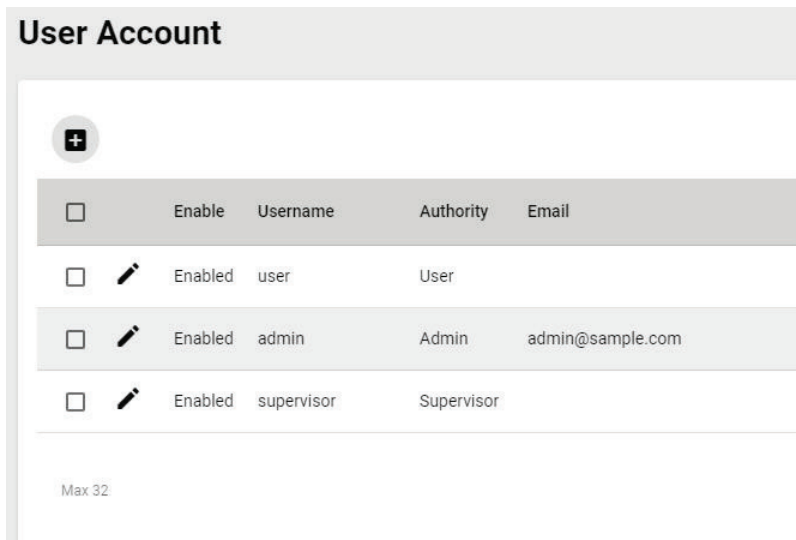



There is a search function on the upper right of the User Account page. Type the username you want to search for.

Editing Existing Accounts

Select the account you want to edit and click the  icon.

User Account

+

	Enable	Username	Authority	Email
<input type="checkbox"/>		Enabled	user	User
<input type="checkbox"/>		Enabled	admin	Admin admin@sample.com
<input type="checkbox"/>		Enabled	supervisor	Supervisor

Max 32

Configure the following settings.

Edit Account Settings

Enable *
Enabled ▼

Username
test CHANGE PASSWORD

At least 4 characters 4 / 32

Authority *
User ▼

Email 0 / 63

CANCEL
APPLY

Enabled

Setting	Description	Factory Default
Enabled	This enables the user account.	Enabled
Disabled	This disables the user account.	

To change the password, click **CHANGE PASSWORD**.

Edit Account Password

Username
test
At least 4 characters 4 / 32

New Password *
At least 4 characters 0 / 63

Confirm Password *
At least 4 characters 0 / 63

BACK
APPLY

New Password

Setting	Description	Factory Default
0 to 63 characters	Enter the password to use for this account.	None

Confirm Password

Setting	Description	Factory Default
0 to 63 characters	Reenter the password to confirm it.	None

Click **APPLY** to finish changing the password.

Authority

Setting	Description	Factory Default
admin	This account has read/write access for all configuration parameters.	admin
supervisor	This account has read/write access for some specific configuration parameters.	
user	This account can only view some specific configuration parameters.	

Email

Setting	Description	Factory Default
Input an email address	Input an email address for the account if required.	None

When finished, click **APPLY** to save your changes.



NOTE

Refer to Appendix A for detailed descriptions for read/write access privileges for the admin, supervisor, and user authority levels.

Creating a New Account

You can create new account by clicking the  icon on the configuration page.

User Account



	Enable	Username	Authority	Email
<input type="checkbox"/>	Enabled	user	User	
<input type="checkbox"/>	Enabled	admin	Admin	admin@sample.com
<input type="checkbox"/>	Enabled	supervisor	Supervisor	

Max 32



Configure the following settings.

Create New Account

Enable *
Enabled ▼

Username *
At least 4 characters 0 / 32

Authority *
▼

New Password *  Confirm Password * 
At least 4 characters 0 / 63
At least 4 characters 0 / 63

Email
0 / 63

CANCEL
CREATE

Enabled

Setting	Description	Factory Default
Enabled	This enables the account.	Enabled
Disabled	This disables the account.	

Username

Setting	Description	Factory Default
Input a username, 4 to 32 characters	Input a new username for this account.	None

Authority

Setting	Description	Factory Default
admin	This account has read/write access of all configuration parameters.	None
supervisor	This account has read/write access for some specific configuration parameters.	
user	This account can only view some specific configuration parameters.	

In order to enhance security, we suggest you create a new account with the user authority.

New Password

Setting	Description	Factory Default
0 to 63 characters	Input a new password for this account.	None

Confirm Password

Setting	Description	Factory Default
0 to 63 characters	Reenter the password to confirm.	None

Email

Setting	Description	Factory Default
Input an email address	Input an email address for the account if required.	None





When finished, click **CREATE** to complete.

Delete an Existing Account

To delete the existing account, simply select the account you want to delete, and then click the  icon on the configuration page.

User Account



	Enable	Username	Authority	Email
<input checked="" type="checkbox"/>		Enabled	user	User
<input type="checkbox"/>		Enabled	admin	Admin admin@sample.com
<input type="checkbox"/>		Enabled	supervisor	Supervisor

Click **DELETE** to delete the account.

Delete Account

Are you sure you want to delete the selected account?

[CANCEL](#) [DELETE](#)

Password Policy

In order to prevent hackers from cracking weak passwords, a password policy can be set. The password policy can force users to create passwords with a minimum length and complexity, and can also set a maximum lifetime for the password to ensure it is changed periodically.

Password Policy

Minimum Length *

4

4 - 63

Password Complexity Strength Check

At least one digit (0-9)

At least one upper case letter (A-Z)

At least one lower case letter (a-z)

At least one special character ({}|~!@#\$%^&*-_.)

Password Max-life-time *

0

0 - 365 day

APPLY

Minimum Length

Setting	Description	Factory Default
Input from 4 to 63	This sets the minimum length of the password.	4

Password Complexity Strength Check

Setting	Description	Factory Default
digit, letter cases, special characters	These determine the required complexity for the password. Multiple options may be checked.	None

Password Max-life-time (day)

Setting	Description	Factory Default
Input from 0 to 365	This determines how long the password can be used before it must be changed.	0



When finished, click **APPLY** to save your changes.

Online Accounts

The **Online Accounts** function allows users to view who is connected to the device. You can remove currently online users.

Online Accounts

🔄 📄

Username	Authority	IP Address	Interface	Idle Time (sec.)
 test	User	192.168.127.200	HTTP(S)	6
 admin	Admin	192.168.127.200	HTTP(S)	0

Select the  icon and select **REMOVE** to disconnect the user.

Remove online account

Are you sure you want to remove this online account?

[CANCEL](#) [REMOVE](#)

Network

This section describes how to configure the switch's network settings, including IP Configuration, DHCP Server, and DHCP Relay Agent with Option 82.

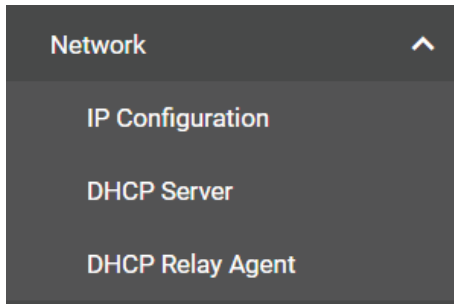

IP Configuration

Users can configure the IP settings of the switch.

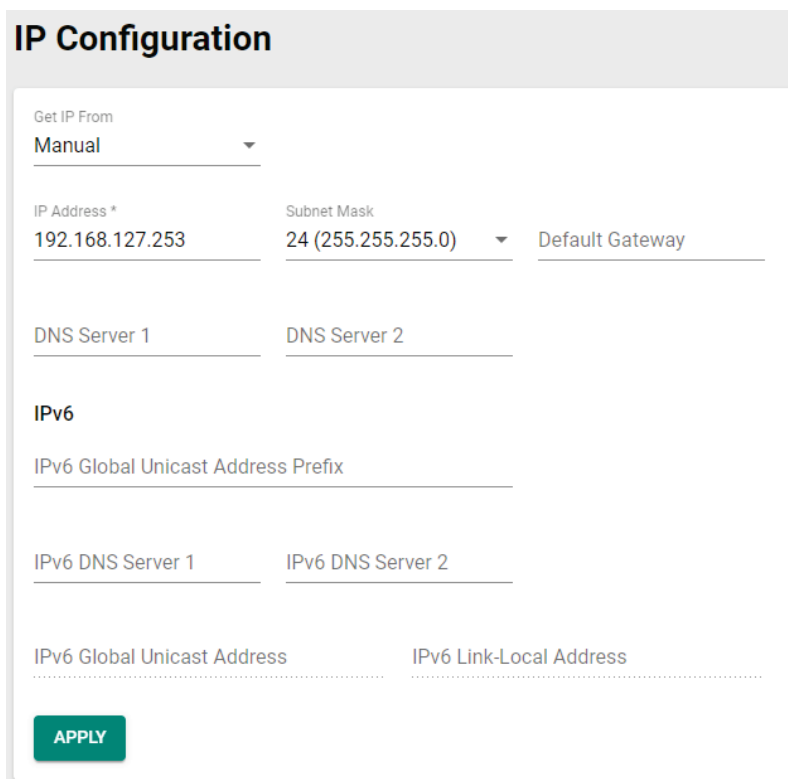
A screenshot of the "IP Configuration" form. The form has a title "IP Configuration" at the top. Below the title, there is a dropdown menu labeled "Get IP From" with "Manual" selected. Underneath, there are three input fields: "IP Address *" with the value "192.168.127.253", "Subnet Mask" with the value "24 (255.255.255.0)", and "Default Gateway". Below these are two input fields for "DNS Server 1" and "DNS Server 2". There is a section header "IPv6" followed by an input field for "IPv6 Global Unicast Address Prefix". Below that are two input fields for "IPv6 DNS Server 1" and "IPv6 DNS Server 2". At the bottom of the form, there are two dotted lines for "IPv6 Global Unicast Address" and "IPv6 Link-Local Address". A green "APPLY" button is located at the bottom left of the form.

Get IP From

Setting	Description	Factory Default
Manual	The IP address of the switch must be set manually.	Manual
DHCP	The IP address of the switch will be assigned automatically by the network's DHCP server.	

IP Address

Setting	Description	Factory Default
Input the IP address for the switch	Specify the IP address to use for the switch.	192.168.127.253

Subnet Mask

Setting	Description	Factory Default
Input the subnet mask for the switch	Specify the subnet mask to use for the switch.	24(255.255.255.0)

Default Gateway

Setting	Description	Factory Default
Input the IP address for the gateway	Specify the IP address of the gateway that connects the LAN to a WAN or another network.	None

DNS Server 1

Setting	Description	Factory Default
Input the IP address of the 1st DNS server	Specify the IP address of the 1st DNS server used by your network. After specifying the DNS server's IP address, you can use the switch's URL (e.g., www.mymoxaswitch.com) to open the web console instead of entering the IP address.	None

DNS Server 2

Setting	Description	Factory Default
Input the IP address of the 2nd DNS server	Specify the IP address of the 2nd DNS server used by your network. The switch will use the secondary DNS server if the first DNS server fails to connect.	None

IPv6 Global Unicast Address Prefix (Prefix Length: 64 bits)

Setting	Description	Factory Default
Global Unicast Address Prefix	The prefix value must be formatted according to the RFC 2373 IPv6 Addressing Architecture, using 8 colon-separated 16-bit hexadecimal values. One double colon can be used in the address to indicate the appropriate number of zeros required to fill the undefined fields. Note: This feature is only available in Advanced Mode .	None

IPv6 DNS Server 1

Setting	Description	Factory Default
Input the IPv6 IP address of the 1st DNS server	Specify the IPv6 address of the 1st DNS server used by your network. After specifying the DNS server's IP address, you can use the switch's URL (e.g., www.mymoxaswitch.com) to open the web console instead of entering the IP address. Note: This feature is only available in Advanced Mode .	None

IPv6 DNS Server 2

Setting	Description	Factory Default
Input the IPv6 address of the 2nd DNS server	Specify the IPv6 address of the 2nd DNS server used by your network. The Moxa switch will use the secondary DNS server if the first DNS server fails to connect. Note: This feature is only available in Advanced Mode .	None

IPv6 Global Unicast Address

Setting	Description	Factory Default
Input the IPv6 Global Unicast address	Displays the IPv6 Global Unicast address. The network portion of the Global Unicast address can be configured by specifying the Global Unicast Prefix and using an EUI-64 interface ID in the low order 64 bits of the address. The host portion of the Global Unicast address is automatically generated using the modified EUI-64 form of the interface identifier (the switch's MAC address). Note: This feature is only available in Advanced Mode .	None

IPv6 Link-Local Address

Setting	Description	Factory Default
Input the IPv6 Link-Local address	The network portion of the Link-Local address is FE80 and the host portion of the Link-Local address is automatically generated using the modified EUI-64 form of the interface identifier (the switch's MAC address). Note: This feature is only available in Advanced Mode .	None

When finished, click **APPLY** to save your changes.

DHCP Server

This section describes how to configure the DHCP server settings for Moxa's switch. First, click the **General** tab.

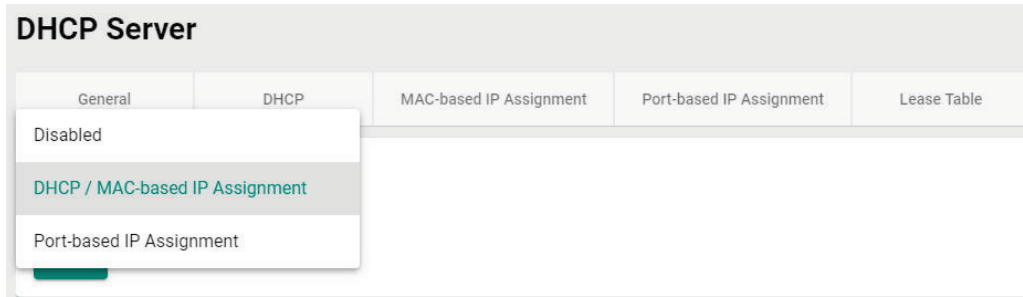

The screenshot shows the 'DHCP Server' configuration page with the 'General' tab selected. A dropdown menu is open, showing three options: 'Disabled', 'DHCP / MAC-based IP Assignment' (which is highlighted in blue), and 'Port-based IP Assignment'.

Then select **DHCP/MAC-based IP Assignment** and click **APPLY**.



NOTE

The DHCP server will use UDP port 67 to send messages to the DHCP client.

DHCP

Select the **DHCP** tab and then click the **+** icon on the configuration page to create a new DHCP server pool.



The screenshot shows the DHCP configuration page with a table. The table has columns: 'Enable', 'Pool IP Range', 'Subnet Mask', 'Lease Time (sec)', 'Default Gateway', 'DNS Server 1', 'DNS Server 2', and 'NTP Server'. A red box highlights the '+' icon in the top left corner of the table area.

Configure the following parameters.

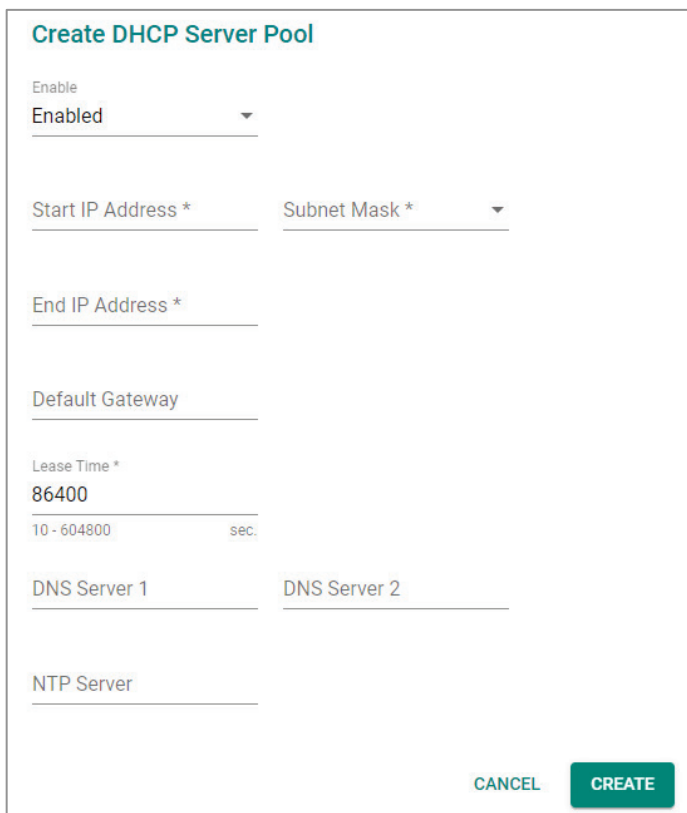

The screenshot shows the 'Create DHCP Server Pool' form. The 'Enable' dropdown is set to 'Enabled'. The 'Start IP Address *' and 'Subnet Mask *' fields are empty. The 'End IP Address *' field is empty. The 'Default Gateway' field is empty. The 'Lease Time *' field is set to '86400' with a unit of 'sec.' and a range of '10 - 604800'. The 'DNS Server 1' and 'DNS Server 2' fields are empty. The 'NTP Server' field is empty. There are 'CANCEL' and 'CREATE' buttons at the bottom right.



NOTE

Users can only create one IP pool. It can be connected to different network subnets with the Management IP of the switch.

Enable

Setting	Description	Factory Default
Enabled	Enables the DHCP server pool.	Disabled
Disable	Disables the DHCP server pool.	

Start IP Address

Setting	Description	Factory Default
Input the first IP address	Specify the first IP address for the pool.	None

Subnet Mask

Setting	Description	Factory Default
Select from the drop-down list	Specify the subnet mask for the pool.	None

End IP Address

Setting	Description	Factory Default
Input the last IP address	Specify the last IP address for the pool.	None

Default Gateway

Setting	Description	Factory Default
Input the IP address of the default gateway	Specify the default gateway for clients to use.	None

Lease Time (sec.)

Setting	Description	Factory Default
Input the lease time for the DHCP, from 10 to 604,800 seconds (up to 7 days)	Specify the lease time for DHCP IP assignments.	86400

DNS Server 1

Setting	Description	Factory Default
Input the IP address of the 1st DNS server	Specify the IP address of the 1st DNS server for clients to use.	None

DNS Server 2

Setting	Description	Factory Default
Input the IP address of the 2nd DNS server	Specify the IP address of the 2nd DNS server for clients to use.	None

NTP Server

Setting	Description	Factory Default
Input the address of the NTP server	Specify the NTP server clients will use.	None

When finished, click **CREATE**.

MAC-based IP Assignment

Users can assign an IP address for a specific MAC address. This can be useful if you always want the same IP address to be assigned to a specific device, even if it is reconnected or connected to a different port.

Click the **MAC-based IP Assignment** tab, and then click the + icon on the configuration page.

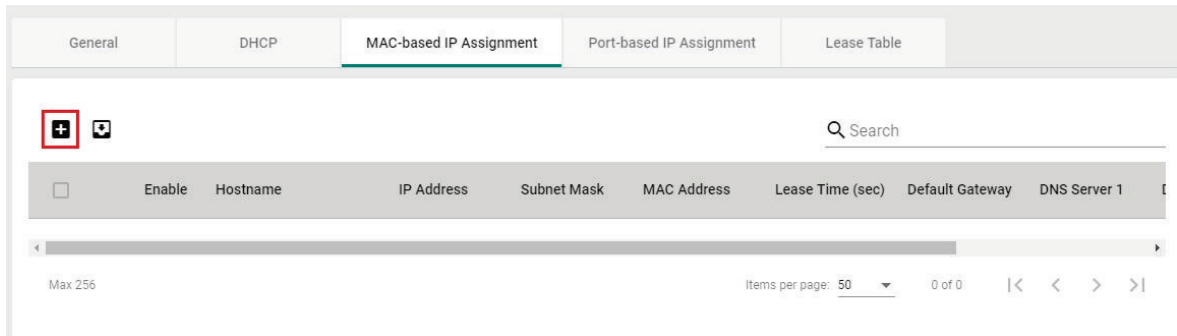

Configure the following parameters.

Create Entry

Enable
Enabled

Hostname * i
0 / 63

IP Address * Subnet Mask *

MAC Address *

Default Gateway

Lease Time *
86400
10 - 604800 sec.

DNS Server 1 DNS Server 2

NTP Server

CANCEL CREATE

Enable

Setting	Description	Factory Default
Enabled	Enables the MAC-based IP assignment entry.	Enabled
Disabled	Disables the MAC-based IP assignment entry.	

Hostname

Setting	Description	Factory Default
Enter a hostname between 0 and 63 characters	Specify a hostname to use for the DHCP client.	None

IP Address

Setting	Description	Factory Default
Input the assigned IP address	Specify the IP address to assign to the client.	None

Subnet Mask

Setting	Description	Factory Default
Select from the drop-down list	Specify the subnet mask to use for the client.	None

MAC Address

Setting	Description	Factory Default
Input the assigned MAC address	Specify the MAC address of the device you want to assign an IP address to. Make sure the MAC address is entered in the correct format. Here is an example: 28-d2-44-D3-e3-f2 or 28:d2:44:D3:e3:f2.	None

Default Gateway

Setting	Description	Factory Default
Input the IP address of the default gateway	Specify the default gateway for the client to use.	None

Lease Time (sec.)

Setting	Description	Factory Default
Input the lease time for the DHCP, from 10 to 604800.	Define how long before the IP address needs to be reassigned.	86400

DNS Server 1

Setting	Description	Factory Default
Input the IP address of the 1st DNS server	Specify the IP address of the 1st DNS server for the client to use.	None

DNS Server 2

Setting	Description	Factory Default
Input the IP address of the 2nd DNS server	Specify the IP address of the 2nd DNS server for the client to use.	None

NTP Server

Setting	Description	Factory Default
Input the address of the NTP server	Specify the NTP server the client will use.	None

When finished, click **CREATE**.

Port-based IP Assignment

Users can assign an IP to a device based on what switch port it is connected to. This can be useful if you want to always use the same IP for a device connected to a specific port, even if it is replaced with a different device.

On the **General** tab, select **Port-based IP Assignment**. Click **APPLY**.

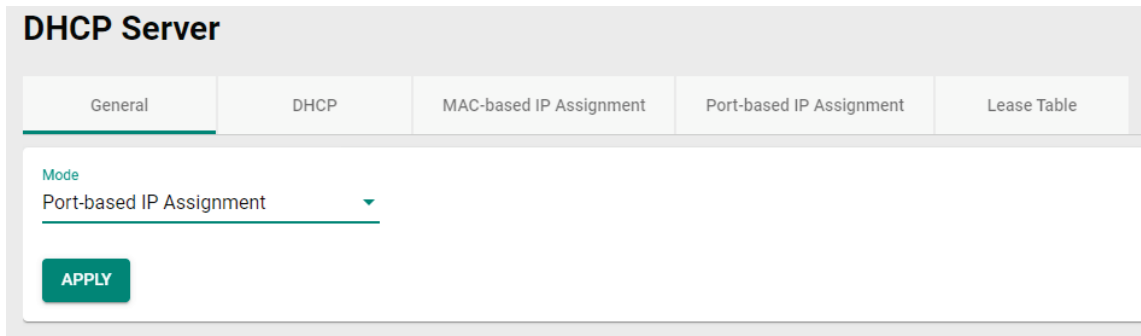

The screenshot shows the 'DHCP Server' configuration page with the 'General' tab selected. The 'Mode' dropdown menu is set to 'Port-based IP Assignment'. A green 'APPLY' button is visible at the bottom left of the configuration area.

Next, click the **Port-based IP Assignment** tab, and then click the **+** icon on the configuration page.

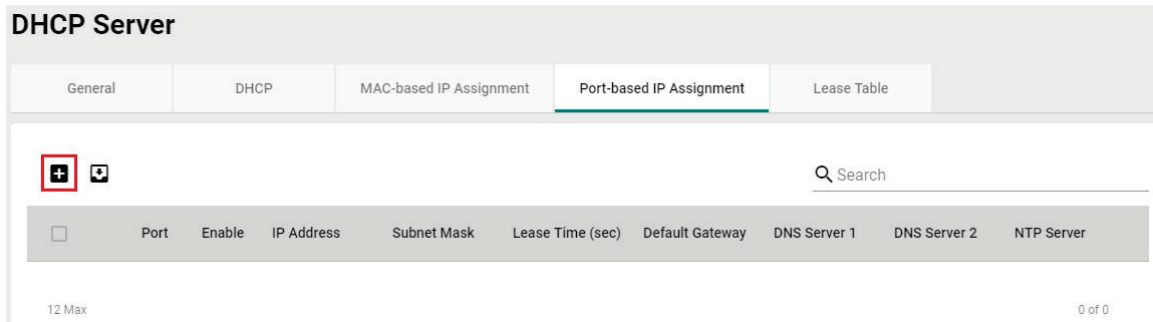

The screenshot shows the 'DHCP Server' configuration page with the 'Port-based IP Assignment' tab selected. A table is visible with columns: Port, Enable, IP Address, Subnet Mask, Lease Time (sec), Default Gateway, DNS Server 1, DNS Server 2, and NTP Server. A red box highlights a '+' icon in the top left corner of the table area. A search bar is located in the top right corner. The table is currently empty, showing '12 Max' and '0 of 0' entries.

Configure the following parameters.

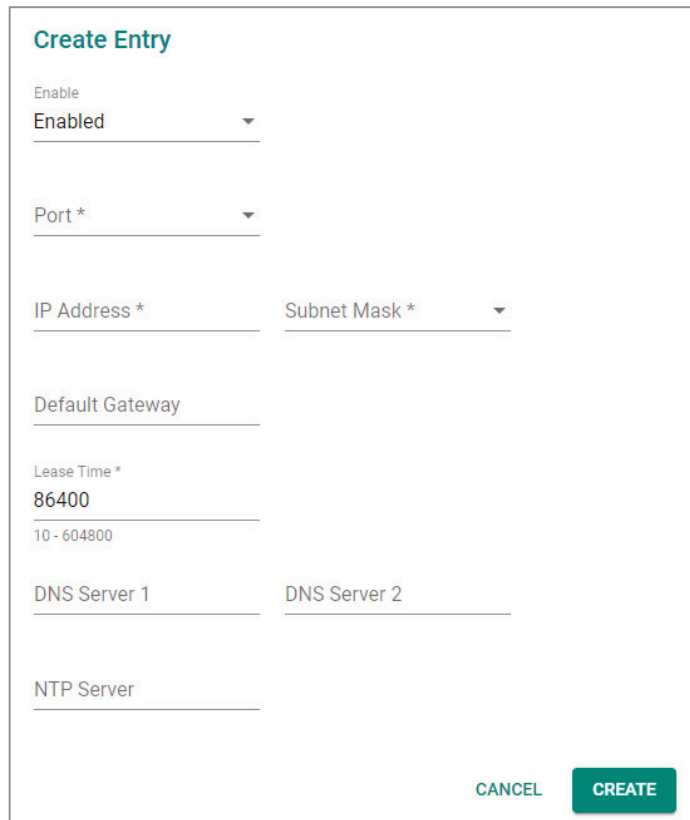

The screenshot shows the 'Create Entry' form for configuring a port-based IP assignment. The form includes the following fields:

- Enable:** A dropdown menu set to 'Enabled'.
- Port *:** A dropdown menu.
- IP Address *:** A text input field.
- Subnet Mask *:** A dropdown menu.
- Default Gateway:** A text input field.
- Lease Time *:** A text input field containing '86400', with a range of '10 - 604800' indicated below it.
- DNS Server 1:** A text input field.
- DNS Server 2:** A text input field.
- NTP Server:** A text input field.

At the bottom right of the form, there are two buttons: 'CANCEL' and 'CREATE'.

Enable

Setting	Description	Factory Default
Enabled	Enables the port-based IP assignment entry.	Enabled
Disabled	Disables the port-based IP assignment entry.	

Port

Setting	Description	Factory Default
Select from 1 to 28	Select which switch port the DHCP server will assign an IP address for.	None

IP Address

Setting	Description	Factory Default
Input the assigned IP address	Specify the IP address to assign to the client.	None

Subnet Mask

Setting	Description	Factory Default
Select from the drop-down list	Specify the subnet mask to use for the client.	None

Default Gateway

Setting	Description	Factory Default
Input the IP address of the default gateway	Specify the default gateway for the client to use.	None

Lease Time (sec.)

Setting	Description	Factory Default
Input the lease time for the DHCP, from 10 to 604800	Define how long before the IP address needs to be reassigned.	86400

DNS Server 1

Setting	Description	Factory Default
Input the IP address of the 1st DNS server	Specify the IP address of the 1st DNS server for the client to use.	None

DNS Server 2

Setting	Description	Factory Default
Input the IP address of the 2nd DNS server	Specify the IP address of the 2nd DNS server for the client to use.	None

NTP Server

Setting	Description	Factory Default
Input the address of the NTP server	Specify the NTP server the client will use.	None

When finished, click **CREATE**.

Lease Table

Click Lease Table to view detailed information for the hostname, IP address, MAC address, and time left for each lease.

DHCP Server				
General	DHCP	MAC-based IP Assignment	Port-based IP Assignment	Lease Table
<div style="display: flex; justify-content: space-between; align-items: center;"> 🔄 📄 🔍 Search </div>				
Hostname	IP Address	MAC Address	Time Left	
CINDY-YANG01	192.168.127.1	c8:cb:b8:02:26:5f	23 h: 57 m: 41 s	

Item	Description
Hostname	The hostname of the client.
IP Address	The IP address of the client.
MAC Address	The MAC address of the client.
Time Left	The amount of time left on the DHCP lease for the client.

DHCP Relay Agent

Overview

DHCP Relay agent is used when the host and the DHCP server are in different subnets. Normally, the DHCP packets cannot be forwarded through different subnets and a **DHCP Relay agent** is required to convert the DHCP broadcast packet from the client to a unicast packet to the DHCP server. If there is not a DHCP relay agent, the L3 switch will discard the DHCP broadcast packet from the client since it does not forward broadcast packets from different network segments.

Option 82 information can be inserted into a client's DHCP packets when a DHCP Relay Agent forwards client-originated DHCP packets to a DHCP server. This information serves as a reference for the DHCP server to identify the DHCP Relay Agent that the DHCP packets were sent from. When **Option 82** is applied, the closer the DHCP Relay Agent is to the client, the more precisely the client's position can be determined.

How Does DHCP Relay Agent Work?

When the DHCP Relay Agent is set on an L3 switch, the L3 switch would convert the broadcast packets to unicast packet and routes them to the DHCP server.

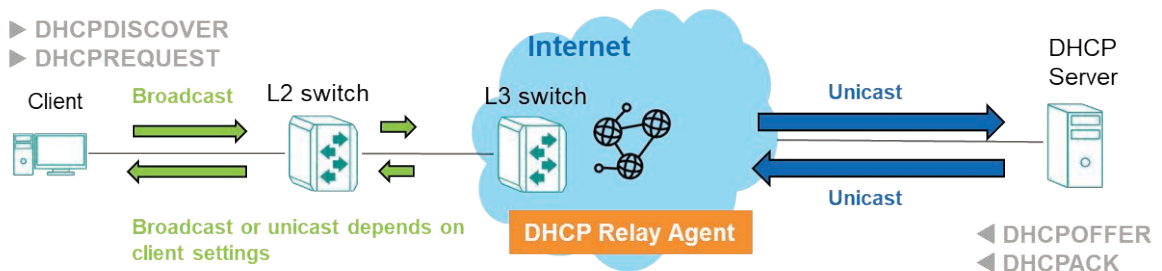

When the DHCP Relay Agent is set on an L2 switch, the switch would convert the broadcast packets to unicast packets and forward them to the L3 switch to route to the DHCP server.

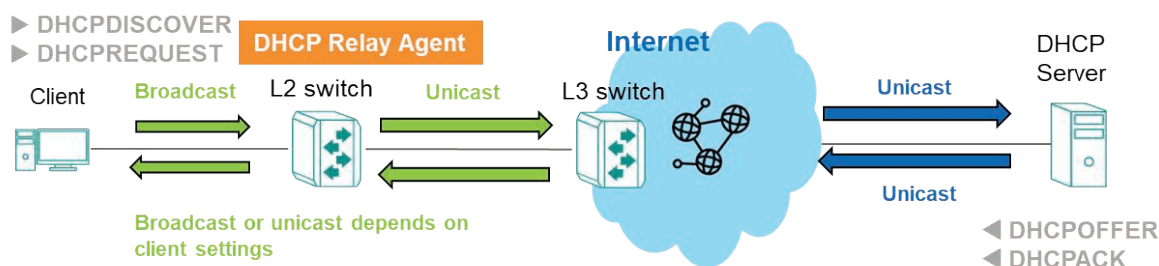

How Does Option 82 Work?

When **Option 82** is enabled, the DHCP relay agent inserts Option 82 information into client-originated DHCP packets before forwarding them to the DHCP server. This information contains two sub-options: Circuit ID and Remote ID. The Circuit ID is generated by the switch, while the Remote ID can be configured by the user. By including this information in the DHCP packets, the DHCP server is able to identify the location from where the DHCP packets were sent from.

DHCP Relay Agent/Option 82 Settings

The steps to configure a DHCP Relay Agent on an L2 switch or an L3 switch are the same. However, users may encounter two scenarios:

DHCP Relay Agent is set up on an L2 switch:

If users set up a DHCP Relay Agent on an L2 switch, an L3 switch capable of routing the frame to another subnet is still required. However, the L3 switch does not need to enable the DHCP Relay Agent function.

DHCP Relay Agent is set up on an L3 switch:

If users set up a DHCP Relay Agent on an L3 switch, and any L2 switch is connected to the L3 switch, then the L2 switch does not need to enable the DHCP Relay Agent function.

The following are the steps to configure a **DHCP Relay Agent**:

1. Click **General**.
2. **Enable** DHCP Relay Agent.
3. Enter the **Server IP Address**. Please note, users can enter a maximum of 4 server IP addresses.
4. Click **APPLY** to save the configurations.



NOTE

If users do not enter any server IP address, even with DHCP Relay Agent enabled, no DHCP server will reply to the packets from the clients.

5. Scroll down the page and click  to edit the port connected to the server.
6. Select **Enabled** under Relay.
7. Select **Trusted** under Status.
8. (Specify the Status as **Untrusted** if the user expects the switch to be the first relay agent to prevent the DHCP packet being maliciously revised.)
9. Select the port connected to the client from the drop-down list of **Copy Configuration to Ports**.
10. Click **APPLY** to save the configurations.



NOTE

Both the port connected to the client and the port connected to the server should have the DHCP Relay Agent function enabled.

The following are the steps to configure **Option 82**:

1. Click **Option 82**.
2. Choose **Remote ID Type**.
(If you select **Other**, please enter the Remote ID Value that is less than 64 characters.)
3. Click **APPLY** to save the configurations.
4. Scroll down the page and click  to edit the port connected to the client.
5. Select **Enabled** of Option 82.
6. Click **APPLY** to save the configurations.



NOTE

Only the port connected to the client should have **Option 82** enabled when applying the **Option 82** function.

Click **DHCP Relay Agent** on the function menu.

DHCP Relay Agent

General

Option 82

DHCP Relay Agent *

Select the **General** tab and configure the following settings.

DHCP Relay Agent





Setting	Description	Factory Default
Enabled	Enable the DHCP Relay Agent.	Disabled
Disabled	Disable the DHCP Relay Agent.	

1st/2nd/3rd/4th Server IP Address

Setting	Description	Factory Default
Server IP address	Specify the 1st, 2nd, 3rd, and 4th server IP address	None

When finished, click **APPLY** to save your settings.

Next, click the  icon to configure the setting for the port.

	Port	Relay	Status
	1/1	Disabled	Trusted
	1/2	Disabled	Trusted
	1/3	Disabled	Trusted
	1/4	Disabled	Trusted

Configure the following settings.

Relay

Setting	Description	Factory Default
Enabled	Enable the Relay function on the port.	Disabled
Disabled	Disable the Relay function on the port.	

Status

Setting	Description	Factory Default
Trusted	The relay on the port is trusted, and DHCP packets with Option 82 or with non-zero giaddr will be accepted.	Trusted
Untrusted	The relay on the port is untrusted, and DHCP packets with Option 82 or with non-zero giaddr will be discarded.	

Copy Configurations to Ports

Setting	Description	Factory Default
Select the port(s) from the drop-down list	Select the port(s) you want to copy the same configurations to.	None

When finished, click **APPLY** to save your changes.

Next, select **Option 82 tab**.

Configure the following settings.

Remote ID Type

Setting	Description	Factory Default
IP	Specify IP address as the remote ID type.	IP
MAC	Specify MAC address as the remote ID type.	
Client ID	Specify Client ID as the remote ID type.	
Other	Specify other option as the remote ID type.	

Remote ID Value (read only except selecting Other as the remote ID type)

Setting	Description	Factory Default
Show the remote ID value	Show the remote ID value with the remote ID type selected.	Varies depending on different options

Remote ID Value (When selecting Other as the remote ID type)





Setting	Description	Factory Default
0 to 64 characters	Specify the remote ID value if you select Other as the remote ID type.	moxa-dhcp-relay

Remote ID Display (read only)

Setting	Description	Factory Default
Remote ID	Show the remote ID.	Remote ID

When finished, click APPLY to save your changes.

Next, click the  icon to configure the settings for the port.

Port	Option 82
 1/1	Disabled
 1/2	Disabled
 1/3	Disabled
 1/4	Disabled

Configure the following settings.

Option 82

Setting	Description	Factory Default
Enabled	Enable Option 82 on the port.	Disabled
Disabled	Disable Option 82 on the port.	

Copy Configurations to Ports

Setting	Description	Factory Default
Select the port(s) from the drop-down list	Select the port(s) you want to copy the same configurations to.	None

When finished, click **APPLY** to save your changes.

Time

This section describes how to configure the **System Time**, **NTP Server**, and **Time Synchronization** settings for the switch. The switch has a time calibration function based on information from an NTP server or a user-specified time and date, allowing functions such as automatic warning emails to include a time and date stamp.

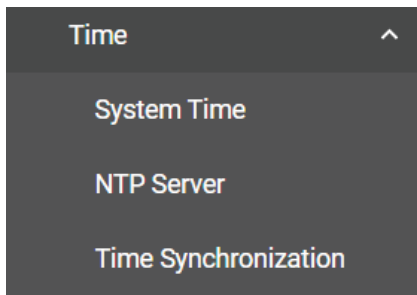

NOTE

The user must update the Current Time and Current Date after the switch has been powered off for an extended period of time (e.g., three days). The user must pay particular attention to this when there is no NTP server or Internet connection available.

System Time

The section describes how to configure the system time.

Time

Click the **Time** tab.

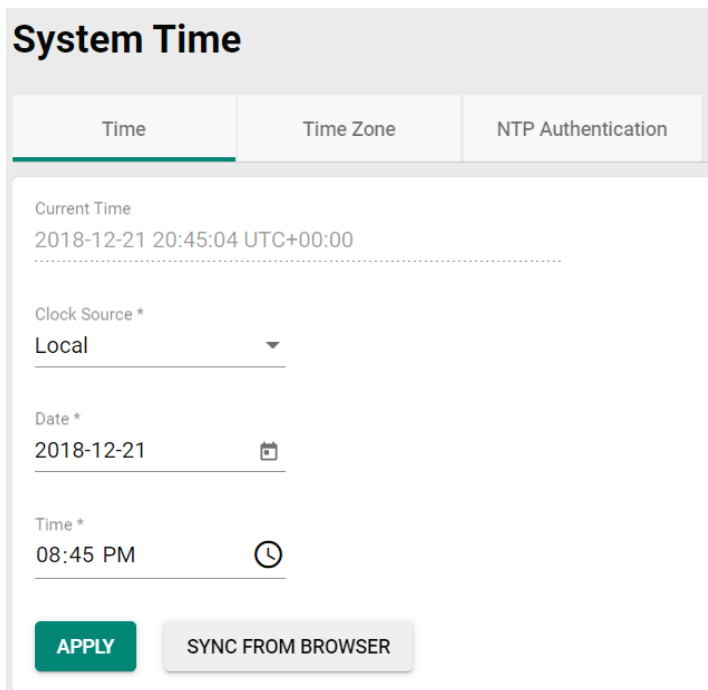
A screenshot of the "System Time" configuration page. The page has three tabs: "Time", "Time Zone", and "NTP Authentication". The "Time" tab is selected. Below the tabs, there are three input fields: "Current Time" with the value "2018-12-21 20:45:04 UTC+00:00", "Clock Source *" with a dropdown menu set to "Local", "Date *" with the value "2018-12-21" and a calendar icon, and "Time *" with the value "08:45 PM" and a clock icon. At the bottom, there are two buttons: "APPLY" and "SYNC FROM BROWSER".

Current Time

Setting	Description	Factory Default
Shows the current time	This automatically shows the current time according to your default settings.	Local

Clock Source

Setting	Description	Factory Default
Select from the drop-down list	Specify whether to set the time manually (Local), from an SNTP server, from an NTP server, or from a PTP master.	Local

Clock Source is from Local

Date

Setting	Description	Factory Default
Select the date	Select the current date.	Local

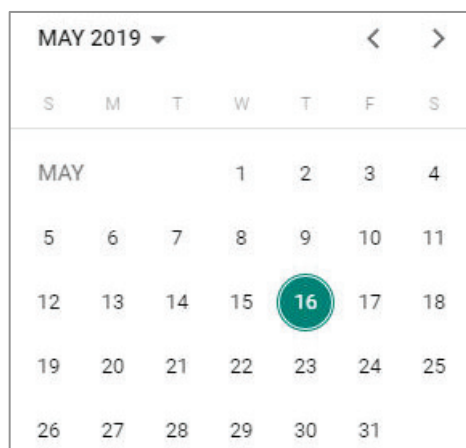

Time

Setting	Description	Factory Default
Input the current time	Specify the current time. You can manually input the time, or you can click SYNC FROM BROWSER to set the time based on the time used by your web browser.	None

Clock Source is from SNTP

Time Server 1

Setting	Description	Factory Default
Input the address of the 1st SNTP time server	Specify the IP or domain address of the 1st SNTP server to use (e.g., 192.168.1.1, time.stdtime.gov.tw, or time.nist.gov).	Time.nist.gov

Time Server 2

Setting	Description	Factory Default
Input the address of the 2nd SNTP time server	Specify the IP or domain address of the secondary SNTP server to use if the first SNTP server fails to connect.	None

Click **APPLY** to complete.

Clock Source is from NTP

If the switch is connecting to an NTP server that requires authentication, refer to the **NTP Authentication** section to configure the NTP key to use.

Time Server 1

Setting	Description	Factory Default
Input the address of the 1st NTP time server	Specify the IP or domain address of the 1st NTP server to use (e.g., 192.168.1.1, time.stdtime.gov.tw, or time.nist.gov).	time.nist.gov

Time Server 2

Setting	Description	Factory Default
Input the address of the 2nd time server	Specify the IP or domain address of the secondary NTP server to use if the first NTP server fails to connect.	None

Click **APPLY** to complete.

Clock Source is from PTP

Select PTP from the drop-down list of **Clock Source**. Click **APPLY** to complete.



NOTE

The request interval for NTP is 512 seconds.

Time Zone

Users can configure the time zone for the switch. Click the **Time Zone** tab.

System Time

Time	Time Zone	NTP Authentication
------	-----------	--------------------

Time Zone *
UTC+00:00

Daylight Saving
Daylight Saving
Enabled

Offset
01:00

Start
Month * Week * Day * Hour * Minute *
Mar last Sun 01 00

End
Month * Week * Day * Hour * Minute *
Oct last Sun 01 00

APPLY

Time Zone

Setting	Description	Factory Default
Select from the drop-down list	Specify the time zone to use for the switch.	GMT (Greenwich Mean Time)

Daylight Saving Time

The Daylight Saving Time settings are used to automatically adjust the time according to regional standards.

Daylight Saving Time

Setting	Description	Factory Default
Enabled	Enables Daylight Saving Time.	Disabled
Disabled	Disables Daylight Saving Time.	

Offset

Setting	Description	Factory Default
User-specified hour	Specify the offset (in HH:MM format) to use during Daylight Saving Time.	None

Start Date

Setting	Description	Factory Default
User-specified date	Specify the date that Daylight Saving Time begins.	None

End Date

Setting	Description	Factory Default
User-specified date	Specify the date that Daylight Saving Time ends.	None

When finished, click **APPLY** to activate the time zone settings.

NTP Authentication

This section describes how to configure NTP Authentication. Click the **NTP Authentication** tab, and then click the  icon on the page.

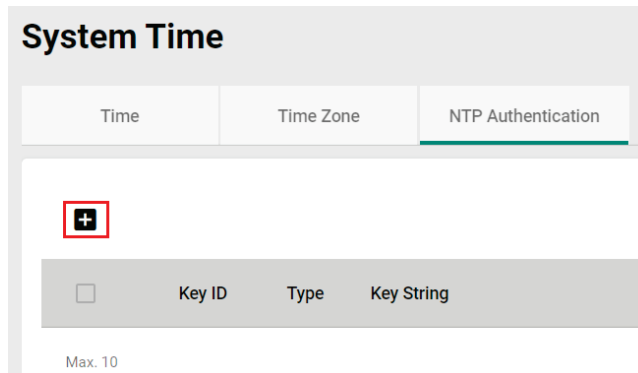

Configure the following settings.

Create Entry

Key ID *

1 - 65535

Type *

MD5

Key String *

0 / 32

Key ID

Setting	Description	Factory Default
Input the Key ID from 1 to 10	Input the Key ID to use for NTP authentication.	None

Type

Setting	Description	Factory Default
Input the authentication type	Input the authentication type.	MD5

Key String

Setting	Description	Factory Default
---------	-------------	-----------------

Input the key string for authentication, from 0 to 32 characters.	Input the password to use for the authentication key.	None
---	---	------

When finished, click **CREATE**.

NTP Server

Click the **NTP Server** on the function menu to perform further configurations.

NTP Server

Setting	Description	Factory Default
Enabled	Enable the NTP server.	Disabled
Disabled	Disable the NTP server.	

Authentication

Setting	Description	Factory Default
Enabled	Enable NTP authentication.	Disabled
Disabled	Disable NTP authentication.	

When finished, click **APPLY** to save your changes.

Time Synchronization

Click **Time Synchronization** on the function menu.

Overview

Precision Time Protocol (PTP) is a Time Synchronization protocol, designed to synchronize clocks through Ethernet networks. The accuracy for IEEE 1588 PTP v2 can be measured in microseconds or nanoseconds. There are three profiles provided in this feature: IEEE 1588 Default 2008, IEC 61850-9-3-2016, and IEEE C37.238-2017.

General Settings

Click the **General** tab for the general settings.

Time Synchronization

General	Port Settings	Status	Port Status
Time Synchronization *			
Disabled			
Profile			
IEEE 1588 Default-2008			
Clock Type *	Delay Mechanism *	Transport Mode *	
Boundary Clock	End-to-End	802.3 Ethernet	
Priority 1 *	Priority 2 *		
128	128		
0 - 255	0 - 255		
Domain Number *	Clock Mode *		
0	Two Step		
0 - 255			
Accuracy Alert *	Maximum Steps Removed *		
1000	255		
50 - 250000000	ns	0 - 255	
APPLY			

Time Synchronization

Setting	Description	Factory Default
Enabled	Enable time synchronization.	Disabled
Disabled	Disable time synchronization.	

Profile

Setting	Description	Factory Default
IEEE 1588 Default-2008	Specify time synchronization profile as IEEE 1588 Default-2008.	IEEE 1588 Default-2008
IEC 61850-9-3-2016	Specify time synchronization profile as IEC 61850-9-3-2016 and parameters such as Delay Mechanism will be fixed to Peer-to-Peer, and Transport Mode will be fixed to 802.3 Ethernet.	
IEEE C37.238-2017	Specify time synchronization profile as IEEE C37.238-2017 and parameters such as Delay Mechanism will be fixed to Peer-to-Peer, and Transport Mode will be fixed to 802.3 Ethernet.	

Clock Type

Setting	Description	Factory Default
Boundary Clock	Set the Boundary Clock as the clock type.	Boundary Clock
Transparent Clock	Set the Transparent Clock as the clock type.	

Delay Mechanism

Setting	Description	Factory Default
End-to-End	Set End-to-End as the delay mechanism.	End-to-End
Peer-to-Peer	Set Peer-to-Peer as the delay mechanism.	

Transport Mode

Setting	Description	Factory Default
---------	-------------	-----------------

802.3 Ethernet	Set 802.3 Ethernet as the transport mode.	802.3 Ethernet
UDP IPv4	Set UDP IPv4 as the transport mode.	

Priority 1

Setting	Description	Factory Default
0 to 255	Set the priority 1 value.	128

Priority 2

Setting	Description	Factory Default
0 to 255	Set the priority 2 value.	128

Domain Number

Setting	Description	Factory Default
0 to 255	Set domain number value.	0

Clock Mode

Setting	Description	Factory Default
One Step	Set One Step as the clock mode.	Two Step
Two Step	Set Two Step as the clock mode.	

Accuracy Alert

Setting	Description	Factory Default
50 to 250000000 (ns)	Set the accuracy alert value.	1000

Maximum Steps Removed

Setting	Description	Factory Default
2 to 255	Set the value of the maximum steps removed.	255

When finished, click **APPLY** to activate the general settings.



NOTE

The EDS-(G)4000 Series only supports Two Step clock mode for the IEEE 1588 Default-2008, IEC 61850-9-3-2016, IEEE C37.238-2017 profiles.

The following steps are to configure Time Synchronization:

1. Click **General**.
2. **Enable Time Synchronization**.
3. Select the Profile from the list: **IEEE 1588 Default 2008**, **IEC 61850-9-3-2016**, and **IEEE C37.238-2017**. Parameters such as Delay Mechanism will be fixed to Peer-to-Peer and Transport Mode will be fixed to **802.3 Ethernet** if the user specifies the Profile as IEC 61850-9-3-2016 and IEEE C37.238-2017.
4. Select the Clock Type from the list: **Boundary Clock** or **Transparent Clock**.
5. Specify Priority 1 and Priority 2 for the Grandmaster election.
6. Specify Domain Number for the switch to join the time synchronization domain, only one domain is allowed to be specified for each switch.
7. Select Clock Mode from the list: **One Step** without follow-up packets or **Two Step** with follow-up packets.
8. Specify Accuracy Alert as the threshold, when the time offset exceeds the threshold, the event notification will be sent.
9. Specify Maximum Steps Removed: The time synchronization packet will be dropped when the maximum number has been reached and will then re-elect the Grandmaster.
10. Click **APPLY** to save the configurations.
11. Click **Port Settings** to configure the time synchronization parameters by port.
12. Scroll down the page and click  to edit by port.
13. **Enable Time Synchronization** by port. For profiles **IEC 61850-9-3-2016** and **IEEE C37.238-2017** selected in the **General** tab, the configurations for **Announce Interval**, **Announce Receipt Timeout**, **Sync Interval** are fixed; for profile **IEEE 1588 Default 2008**, the parameters can be selected from or

specified within a range. Copy the configurations to the ports the user expects to share the same settings from the list and click **APPLY** to save the configurations.





Port Settings

Click the **Port Settings** tab. Click the edit icon  to configure the settings.

Time Synchronization

General
Port Settings
Status
Port Status

IEEE 1588 Default-2008 Profile

	Port	Time Synchronization	Announce Interval	Announce Receipt Timeout (times)
	1/1	Disabled	1 (2 sec.)	3
	1/2	Disabled	1 (2 sec.)	3
	1/3	Disabled	1 (2 sec.)	3
	1/4	Disabled	1 (2 sec.)	3

Edit Port 1/1 Settings

Time Synchronization *
Disabled ▼

Announce Interval *
1 (2 sec.) ▼

Announce Receipt Timeout *
3 times

2 - 10

Sync Interval *
0 (1 sec.) ▼

Delay-Request Interval *
0 (1 sec.) ▼

Copy Configurations ... ▼ 

CANCEL
APPLY

Time Synchronization

Setting	Description	Factory Default
Enabled	Enable time synchronization.	Disabled
Disabled	Disable time synchronization.	

Announce Interval

Setting	Description	Factory Default
---------	-------------	-----------------

From 1 (2 sec.) to 4 (16 sec.)	Set announce interval value.	1 (2 sec.)
--------------------------------	------------------------------	------------

Announce Receipt Timeout

Setting	Description	Factory Default
2 to 10 (times)	Set announce receipt timeout value.	3

Sync Interval

Setting	Description	Factory Default
From -3 (0.125 sec.) to 5 (32 sec.)	Set synchronization interval value.	0 (1 sec.)

Delay-Request Interval

Setting	Description	Factory Default
From -3 (0.125 sec.) to 5 (32 sec.)	Set delay-request interval value.	0 (1 sec.)

Copy Configurations to Ports

Setting	Description	Factory Default
Select the port(s) from the drop-down list	Select the port(s) you want to copy the same configurations to.	0 (1 sec.)

When finished, click **APPLY** to save your changes.

Status

Click the **Status** tab to view the detailed status of time synchronization.

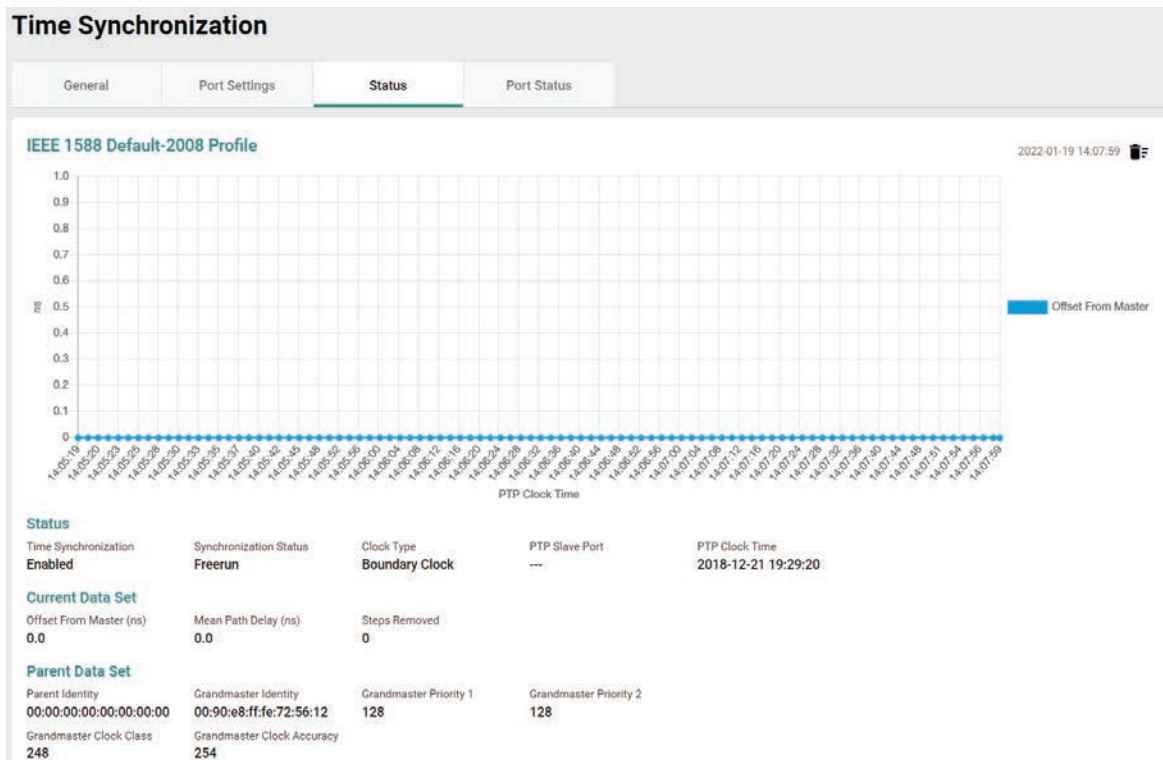

Port Status

Click the **Port Status** tab to view the information of the port status.

Time Synchronization

General | Port Settings | Status | **Port Status**

IEEE 1588 Default-2008 Profile

↻

Port	Port State	Path Delay (ns)
1/1	Disabled	0.0
1/2	Disabled	0.0
1/3	Disabled	0.0
1/4	Disabled	0.0

Port

This section describes how to configure the **Port Interface**, **Link Aggregation**, and **PoE** functions for the switch.



Port Interface

Two functions are included in this section: **Port Settings** and **Linkup Delay**.

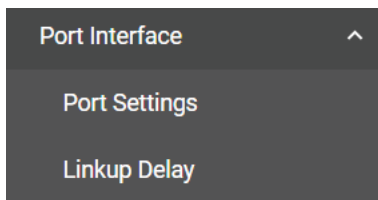

Port Settings

Under **Port Settings**, select the **Settings** tab and then click the  icon on the port you want to configure.

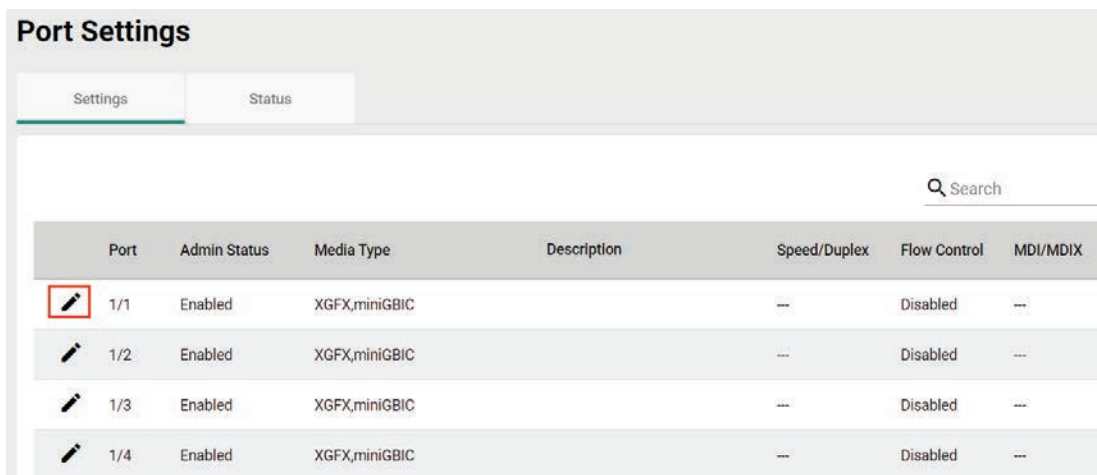

Configure the following parameters.

Edit Port 1/1 Settings

Admin Status *
Enabled ▼

Media Type
XGFX,miniGBIC

Description
0 / 127

Speed/Duplex ▼

Flow Control *
Disabled ▼ ⓘ

MDI/MDIX ▼

Copy Configurations ... ▼

CANCEL
APPLY

Admin Status

Setting	Description	Factory Default
Enable	Allows data transmission through this port.	Enabled
Disabled	Disables data transmission through this port.	

Media Type

Setting	Description	Factory Default
Media type	Displays the media type for each module's port.	Detected media type

Description

Setting	Description	Factory Default
Max. 63 characters	Specify an alias for the port to help differentiate between different ports (e.g., PLC1).	None

Speed/Duplex

Setting	Description	Factory Default
Auto	Allows the port to use the IEEE 802.3u protocol to negotiate with connected devices. The port and connected devices will determine the best speed for that connection.	Auto
10M Half	Choose a fixed speed option if the connected Ethernet device has trouble auto-negotiating line speed.	
10M Full		
100M Half		
100M Full		
1G Full		
10G Half		
10G Full		

Flow Control

This setting enables or disables flow control for the port when the port's speed is set to Auto. The final result will be determined by the Auto process between the switch and connected devices.

Setting	Description	Factory Default
Enable	Enables flow control for this port when the port's speed is set to Auto.	Disabled
Disable	Disables flow control for this port when the port's speed is set to Auto.	

MDI/MDIX

Setting	Description	Factory Default
Auto	Allows the port to auto-detect the port type of the connected Ethernet device, and changes the port type accordingly.	Auto
MDI	Choose MDI or MDIX if the connected Ethernet device has trouble auto-detecting the port type.	
MDIX		

Copy Configurations to Ports

Setting	Description	Factory Default
Select the port(s) from the drop-down list	Allows you to copy the configuration to other port(s).	None

When finished, click **APPLY** to save your changes.

Port Status

To view the status of the ports, click the **Status** tab.

Port	Admin Status	Media Type	Link Status	Description	Flow Control	MDI/MDIX	Port State
1/1	Enabled	XGFX,miniGBIC	Link Down		Disabled	Invalid	Discarding
1/2	Enabled	XGFX,miniGBIC	Link Down		Disabled	Invalid	Discarding
1/3	Enabled	XGFX,miniGBIC	Link Down		Disabled	Invalid	Discarding
1/4	Enabled	XGFX,miniGBIC	Link Down		Disabled	Invalid	Discarding

Linkup Delay

Linkup Delay Overview

Linkup delay is used to prevent a port alternating between link up and link down. It is also sometimes called link flap prevention. This feature is useful when the link connection is unstable. An unstable connection might be caused by a faulty cable, faulty fiber transceiver, duplex mismatch, etc. This feature helps administrators to mitigate the risk of an unstable network, particularly when the topology changes frequently.

Linkup Delay Settings

This section describes how to configure the linkup delay for the ports. Click the **Linkup Delay** menu. The default value is disabled, which means linkup delay is disabled for all ports.

Linkup Delay

Linkup Delay *
Disabled





APPLY

Enable

Setting	Description	Factory Default
Enable	Enables linkup delay.	Disabled
Disabled	Disables linkup delay.	

When finished, click **APPLY** to save your changes.

To configure linkup delay for a port, click the  icon on the port you want to configure.

	Port	Enable	Delay Time	Remaining Time
	1/1	Disabled	2	0
	1/2	Disabled	2	0
	1/3	Disabled	2	0
	1/4	Disabled	2	0

Some parameters need to be configured.

Edit Port 1/1 Settings

Linkup Delay *
Disabled

Delay Time *
2
1 - 1000 sec.

Copy Configurations ... 

CANCEL **APPLY**

Linkup Delay

Setting	Description	Factory Default
Enable	Enables linkup delay for the port.	Disabled
Disable	Disables linkup delay for the port.	

Delay Time (sec.)

Setting	Description	Factory Default
1 to 1000	Specify the linkup delay time from 1 to 1000 seconds.	2

Copy Configurations to Ports

Setting	Description	Factory Default
Select the port(s) from the drop-down list	Allows you to copy the configurations to other port(s).	None

When finished, click **APPLY** to save your changes.

Link Aggregation

Link Aggregation (Port Channel) Overview

Link Aggregation helps balance, optimize, and facilitate the switch's throughput. This method can combine multiple network communications in parallel to maximize data throughput, increasing data communication efficiency for each port. In addition, it also acts as a useful method for network redundancy when a link fails. In general, Link Aggregation supports combining multiple physical switch ports into a single, efficient bandwidth data communication route. This can improve network load sharing and increase network reliability.

Static Trunk

For some networking applications, a situation can arise where traffic from multiple ports is required to be filtered through one port. For example, if there are 30 UHD IP surveillance cameras deployed and connected in a ring, the traffic can reach up to 1 Gbps, causing a surge in traffic that can increase network loading by up to 50%. Hence, the uplink port needs to use the static trunk function to provide more bandwidth and redundancy protection.

LACP

The Link Aggregation Control Protocol (LACP) allows a network device to negotiate an automatic bundling of several ports by sending LACP packets to the peer, a directly connected device that also uses LACP.

Algorithm

In Link Aggregation, three load-sharing hash algorithms can be used: **SMAC**, **DMAC**, and **SMAC + DMAC**.

SMAC: SMAC stands for **Source MAC**, often used as a tool to optimize algorithm parameters. It is also an algorithm to evaluate the most efficient network data communication. SMAC is used for many different client situations.

DMAC: DMAC stands for **Destination MAC**. The packets will be distributed and transmitted to the destination MAC address hash algorithm, and is usually used in many different destination servers situation.

SMAC + DMAC: This can be used for more complex hash algorithm, but where the network just has a few clients and servers.

Link Aggregation Settings

This section describes how to configure link aggregation for each port. Click **Link Aggregation** on the menu and then click the  icon on the configuration page.

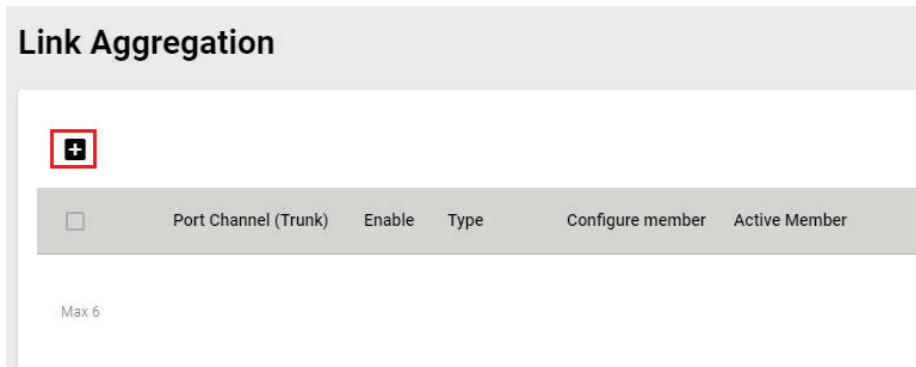

To create a link aggregation group, configure the following parameters.

Create Link Aggregation

LA Group Status *
Enabled ▼

Type *
 ▼

Config Member Port * 
 ▼

Algorithm *
SMAC + DMAC ▼

CANCEL CREATE

LA Group Status

Setting	Description	Factory Default
Enable	Enable link aggregation grouping.	Enabled
Disable	Disable link aggregation grouping.	

Type

Setting	Description	Factory Default
Manual	Configure the link aggregation type manually.	None
LACP	Configure the link aggregation type by LACP.	



Config Member Port

Setting	Description	Factory Default
Select from the ports	Select the ports you want to create for link aggregation grouping.	None

Algorithm (in Advanced Mode only)

Setting	Description	Factory Default
SMAC	Use SMAC as algorithm configuration.	SMAC + DMAC
DMAC	Use DMAC as the algorithm configuration.	
SMAC + DMAC	Use both SMAC and DMAC as the algorithm configuration.	

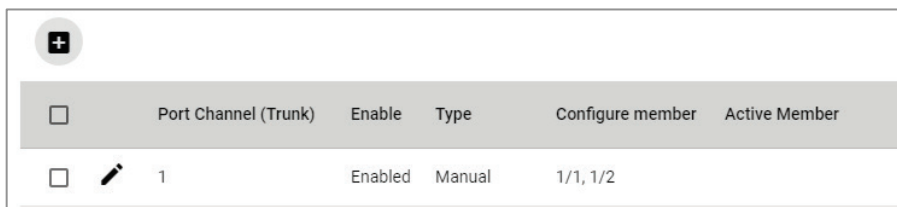

When finished, click **CREATE** to continue.

You can view the current Link Aggregation or Port Channel (Trunk) status on the configuration page. You can also edit or delete by clicking the   icon on the page.



<input type="checkbox"/>	Port Channel (Trunk)	Enable	Type	Configure member	Active Member
<input type="checkbox"/>	1	Enabled	Manual	1/1, 1/2	

Editing Port Setting for Link Aggregation

To edit each port's setting for Link Aggregation, click the  icon on the port name. You can also check the port and then click the  icon for editing the port settings for Link Aggregation.

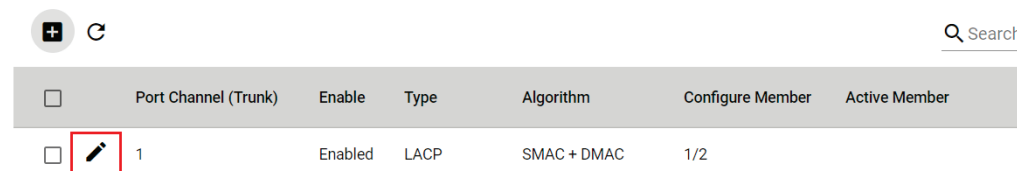

<input type="checkbox"/>	Port Channel (Trunk)	Enable	Type	Algorithm	Configure Member	Active Member
<input type="checkbox"/>	1	Enabled	LACP	SMAC + DMAC	1/2	

Edit the following port settings.

Edit Port Channel 1 Settings

LA Group Status *
Enabled ▼

Type *
LACP ▼

Config Member Port *
1/2 ▼ i

Algorithm *
SMAC + DMAC ▼

CANCEL APPLY

LA Group Status

Setting	Description	Factory Default
Enable	Enable link aggregation grouping.	None
Disable	Disable link aggregation grouping.	

Type

Setting	Description	Factory Default
Manual	Configure link aggregation manually.	None
LACP	Configure link aggregation by LACP.	

Config Member Port

Setting	Description	Factory Default
Select from the ports	Select the ports you want to create link aggregation grouping for.	None

Algorithm (in Advanced Mode only)

Setting	Description	Factory Default
SMAC	Use SMAC as the algorithm configuration.	SMAC + DMAC
DMAC	Use DMAC as the algorithm configuration.	
SMAC + DMAC	Use both SMAC and DMAC as the algorithm configuration.	

When finished, click **APPLY** to continue.

Deleting the Port for Link Aggregation

To delete the port for Link Aggregation, check the port and then click **DELETE**.

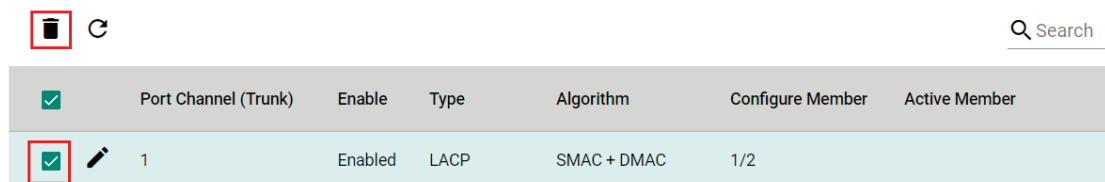

<input checked="" type="checkbox"/>	Port Channel (Trunk)	Enable	Type	Algorithm	Configure Member	Active Member
<input checked="" type="checkbox"/>	1	Enabled	LACP	SMAC + DMAC	1/2	

Click **DELETE** to finish. Note that some features, such as RSTP and VLAN will be set to default values once you delete the Link Aggregation setting.

Delete Link Aggregation

Warning:
Some features (like RSTP, VLAN...etc.) related to selected Link Aggregation will be set to default values.

Are you sure you want to delete the selected Link Aggregation?

[CANCEL](#) [DELETE](#)

PoE

PoE Overview

Power over Ethernet (PoE) has become increasingly popular, due in large part to the reliability provided by PoE Ethernet switches that supply the power to Powered Devices (PD) when AC power is not available or is too expensive to provide locally.

Power over Ethernet can be used with the following types of devices:

- Surveillance cameras
- Security I/O sensors
- Industrial wireless access points
- Emergency IP phones

Recently, more data, video, voice, service, and control packets are converging on one network. Moxa's PoE switches are equipped with many advanced PoE management functions, providing critical security systems with a convenient and reliable Ethernet network. Moreover, Moxa's advanced PoE switches support the high power PoE+ standard, PD failure check, legacy PD detection, and auto power cutting.

PoE Port Settings

Click **PoE** on the menu, and then select the **General** tab on the configuration page.

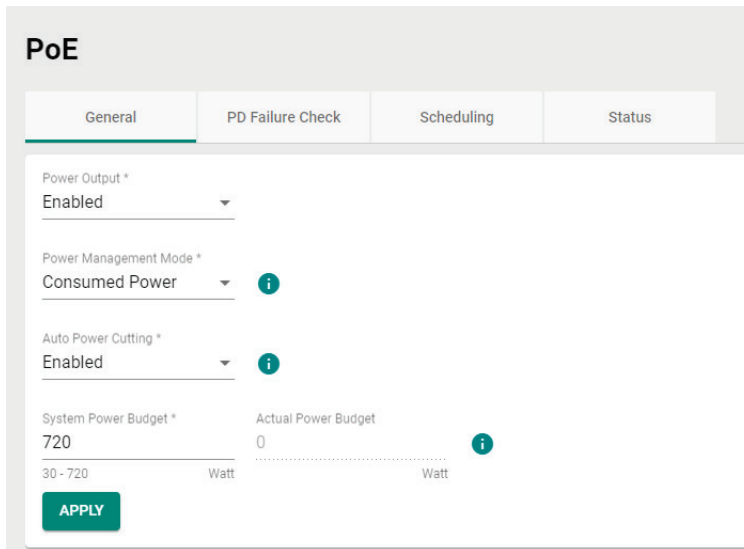

Configure the following settings.

Power Output

Setting	Description	Factory Default
Enable	Enable PoE for all ports on the switch.	Enabled
Disable	Disable PoE for all ports on the switch.	

Power Management Mode

Setting	Description	Factory Default
Allocated Power	Use Allocated Power as the management mode. Calculate the power budget of all ports and ensure the total allocated power is under the power budget limit and that Auto Power Cutting mode will be disabled automatically.	Consumed Power
Consumed Power	Use Consumed Power as the management mode. Calculate the real-time power consumption of all ports and that Auto Power Cutting mode will be enabled automatically.	

Auto Power Cutting

Setting	Description	Factory Default
Enable	The Power Management Mode will be specified as Consumed Power automatically when enabling Auto Power Cutting mode. Auto Power Cutting mode removes the lowest priority and smallest index port power output if the power consumption exceeds the system's power budget.	Enabled
Disable	The Power Management Mode will be specified as Allocated Power automatically when disabling Auto Power Cutting mode.	

System Power Budget (watt)

Setting	Description	Factory Default
Input the value from 30 to 720	Input a value for the system power budget.	720

Actual Power Budget (read only)





Setting	Description	Factory Default
N/A	Show the system power budget	0

When finished, click **APPLY** to save your changes.

Editing PoE Settings for Each Port

In this section, you can also enable the PoE function for specific ports even when the system PoE is disabled under the General tab.

To edit the PoE settings for a port, click the  icon for that port.

	Port	PoE Supported	Power Output	Output Mode	Power Allocation	Legacy PD Detection	Priority
	1/1	No	Enabled	Auto	0	Disabled	Low
	1/2	No	Enabled	Auto	0	Disabled	Low
	1/3	No	Enabled	Auto	0	Disabled	Low
	1/4	No	Enabled	Auto	0	Disabled	Low

Edit Port 1/1 Settings

Power Output *
Enabled ▼

Output Mode * ▼ Legacy PD Detection * ▼
Auto ▼ Disabled ▼

Power Allocation
0

0 - 36 Watt

Priority *
Low ▼

Copy Configurations ... ▼ 

CANCEL
APPLY

Edit the following parameters.

Power Output

Setting	Description	Factory Default
Enable	Enable PoE for this port.	Enabled
Disable	Disable PoE for this port.	

Output Mode

Setting	Description	Factory Default
Auto	Auto mode follows the 802.3af/at standard, which means the power allocation value cannot be changed manually.	Auto
High Power	High Power mode follows the 802.3at standard, but High Power mode allocates 36 watts of power to the PD if it requires more than 30 watts of power.	
Force	Provides power output to non-802.3 af/at PDs when the detected PD has higher/lower resistance or higher capacitance and the acceptable PD resistance range exceeds 2.4 kΩ. The system will prompt you to select Force Mode to allocate 0 to 36 watts of power.	

Legacy PD Detection

The PoE Ethernet Switch includes a Legacy PD Detection function. When the capacitance of the PD is higher than 2.7 μF and less than 10 μF, enabling the Legacy PD Detection will trigger the system to output power to the PD. In this case, it will take a few seconds for PoE power to be output through this port after the switch Legacy PD Detection is enabled.

Setting	Description	Factory Default
Enable	Enable legacy PD detection.	Disabled
Disable	Disable legacy PD detection.	

Power Allocation (watt)

Setting	Description	Factory Default
0	When the output mode is Auto, the value is fixed as 0.	0
36	When the output mode is High Power, the value is fixed as 36.	36
0 to 36	When the output mode is set to Force, input a value from 0 to 36.	36

Priority

Use Power Priority when managing PoE power with measured power mode. You can choose one of the following settings: critical, high, or low. When the PoE measured power exceeds the assigned limit, the switch will disable the PoE port with the lowest priority.

Setting	Description	Factory Default
Critical	Configure the port as critical (highest) priority.	Low
High	Configure the port as high priority.	
Low	Configure the port as low priority.	

Copy Configurations to Ports

Setting	Description	Factory Default
Select the port(s) from the drop-down list	Allows you to copy the configurations to other port(s).	None





When finished, click **APPLY** to save your changes.

PD Failure Check

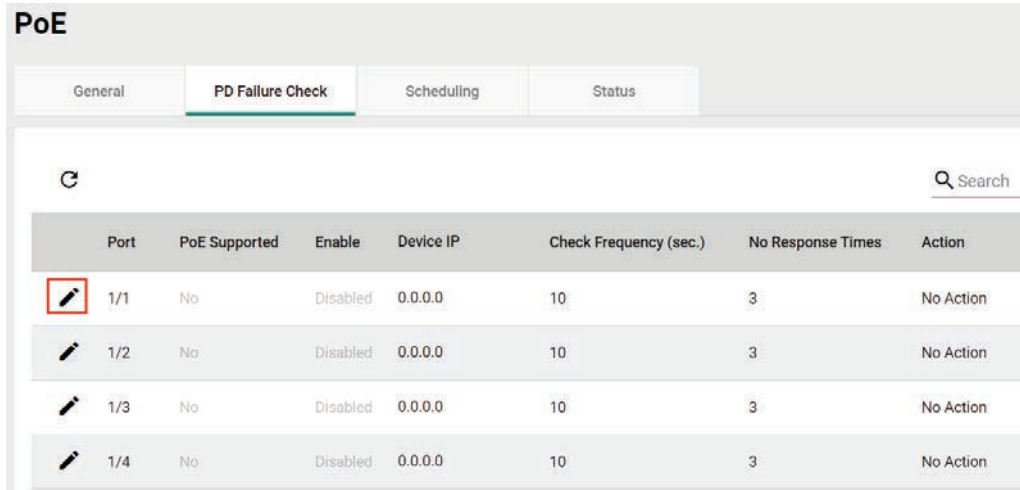
The PoE Ethernet switch can monitor the status of a PD via its IP address. If the PD fails, the switch will not receive a PD response after the defined period, and the PoE powering process will be restarted. This function is very useful for ensuring your network's reliability and reducing your management burden.

Select the **PD Failure Check** tab, and then click the  icon on the port you want to configure.



Port	PoE Supported	Enable	Device IP	Check Frequency (sec.)	No Response Times	Action
 1/1	No	Disabled	0.0.0.0	10	3	No Action
 1/2	No	Disabled	0.0.0.0	10	3	No Action
 1/3	No	Disabled	0.0.0.0	10	3	No Action
 1/4	No	Disabled	0.0.0.0	10	3	No Action

Configure the following parameters.

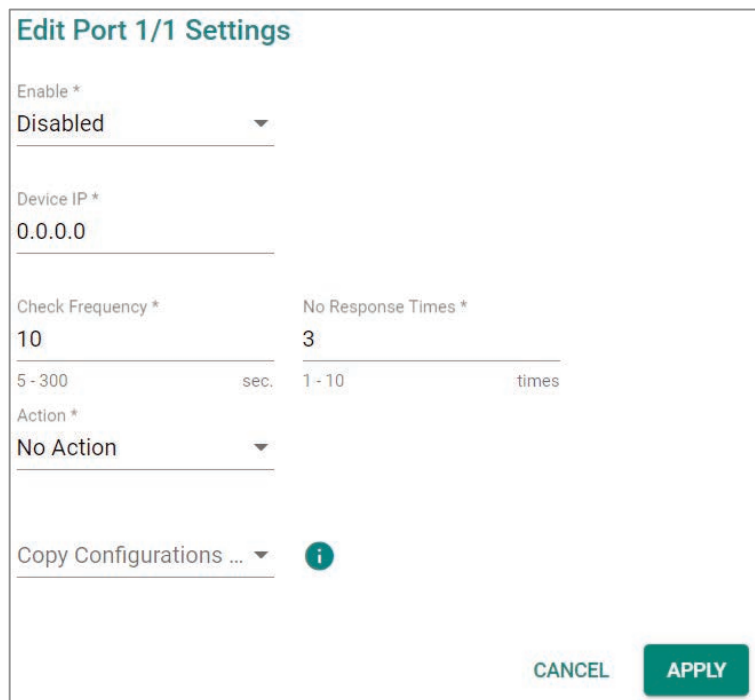

Enable

Setting	Description	Factory Default
Enable	Enable PD failure check for this port.	Disabled
Disable	Disable PD failure check for this port.	

Device IP

Setting	Description	Factory Default
Input the device's IP	Specify the PD's IP address.	0.0.0.0

Check Frequency (sec.)

Setting	Description	Factory Default
5 to 300	Specify how often the PD failure check will run.	10

No Response Times

Setting	Description	Factory Default
1 to 10	The maximum number of IP checking cycles.	3

Action

Setting	Description	Factory Default
No Action	No action will run.	No Action
Restart PD	Restart the PoE device when settings are triggered.	
Shutdown PD	Shut down the PoE device when settings are triggered.	

Copy Configurations to Ports

Setting	Description	Factory Default
Select the port(s) from the drop-down list	Copy the configurations to other port(s).	None

When finished, click **APPLY** to save your changes.

PoE Scheduling

Note that this function is only available in **Advanced Mode**.

Powered devices might not need to be running 24 hours a day, 7 days a week. The PoE Ethernet switch includes a PoE scheduling mechanism that allows users to economize the system's power burden by setting a flexible working schedule for each PoE port. Switch to **Advanced Mode**, click the **Scheduling** tab, and then click the  icon to create the scheduling settings.

PoE

General PD Failure Check **Scheduling** Status

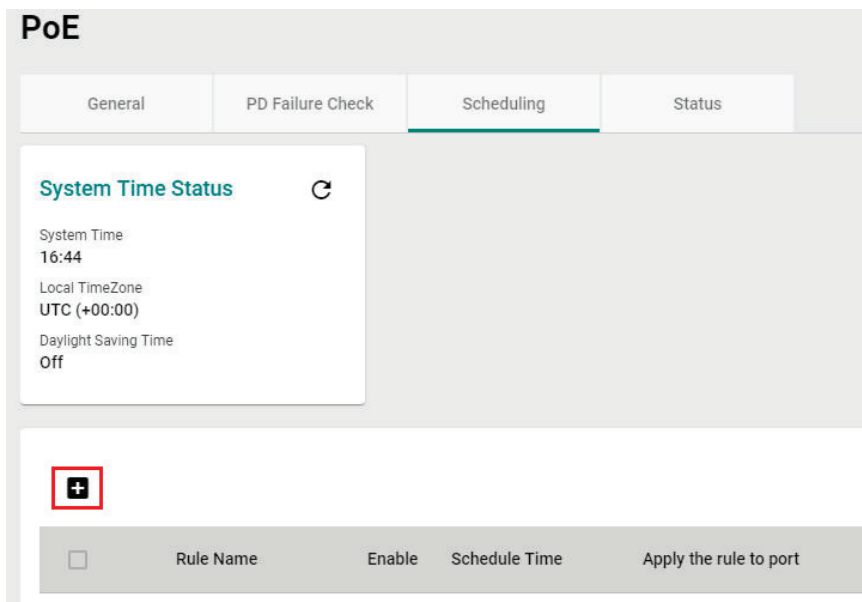
System Time Status 

System Time
16:44

Local Timezone
UTC (+00:00)

Daylight Saving Time
Off



Rule Name	Enable	Schedule Time	Apply the rule to port
<input type="checkbox"/>			

Edit the following parameters.

Create Rule

Rule Name * 0 / 63

Rule *
Enabled ▼

Start Date * 📅

Start Time * --:-- End Time * --:--

Repeat Execution * ▼

Apply the rule to port * ▼

CANCEL
CREATE

Rule Name

Setting	Description	Factory Default
Input the rule name	Input the name for the scheduling rule.	None

Enable

Setting	Description	Factory Default
Enable	Enable PoE Scheduling for this port.	Disabled
Disable	Disable PoE Scheduling for this port.	

Start Date

Setting	Description	Factory Default
Input start date in the mm/dd/yyyy format	Input the start date for the rule.	None

Start Time

Setting	Description	Factory Default
Select the start time in AM/PM hh/mm format	Select the start time for the rule.	None

End Time

Setting	Description	Factory Default
Select the end time in AM/PM hh/mm format	Select the end time for the rule.	None

Repeat Execution

Setting	Description	Factory Default
None	Do not repeat the rule.	None
Daily	Execute the rule every day.	
Weekly	Execute the rule every week.	

Apply the rule to port

Setting	Description	Factory Default
Select the port(s) from the drop-down list	Copy the settings to the port(s) you want to have the same rule.	None

When finished, click **CREATE**. You can check the PoE Scheduling settings in the following figure.

Search					
Edit	Delete	Rule Name	Enable	Schedule Time	Apply the rule to port
		one	Enabled	01:00 - 02:00, Daily	1/1, 1/2

PoE Status

You can view the current PoE setting status by clicking the **Status** tab.

Port	PoE Supported	Power Output	Classification	Current (mA)	Voltage (V)	Consumption (W)	Device Type	Configuration suggestion	PD Failure Check Status
1/1	No	---	---	---	---	---	---	---	---
1/2	No	---	---	---	---	---	---	---	---
1/3	No	---	---	---	---	---	---	---	---
1/4	No	---	---	---	---	---	---	---	---

You can view the PoE status for each port. Refer to the following descriptions.

Name	Description
Port	PoE port on the device.
PoE Supported	Check if this port supports PoE.
Power Output	Power output status (on/off) for the port.
Classification	Check the Classification table below for details.
Current (mA)	The current (mA) that the port supplies.
Voltage (V)	The voltage (V) that the port supplies.
Consumption (W)	The power consumption that the device consumes.
Device Type	Check the Device Type table below for details.
Configuration Suggestion	Refer to the Configuration Suggestion table below for details.
PD Failure Check	Disable/Alive/Not Alive.

Classification

Classification	Max Power (watt) by PSE Output
0	15.4
1	4
2	7
3	15.4
4 (802.3at Type 2)	30
4 (802.3at)	30

Device Type

Item	Description
Not Present	No connection to the port.
Legacy PoE Device	A legacy PD is connected to the port, and the PD has detected that the voltage is too low or high, or the PD's detected capacitance is too high.
IEEE 802.3af	An IEEE 802.3af PD is connected to the port.
IEEE 802.3at	An IEEE 802.3at PD is connected to the port.
NIC	A NIC is connected to the port.
Unknown	An unknown PD is connected to the port.
N/A	The PoE function is disabled.

Configuration Suggestion

Item	Description
Disable PoE power output	When detecting a NIC or unknown PD, the system suggests disabling PoE power output.
Enable "Legacy PD Detection"	When detecting a higher capacitance of PD, the system suggests enabling Legacy PD Detection.
Select Force Mode	When detecting higher/lower resistance or higher capacitance, the system suggests selecting Force Mode.
Select IEEE 802.3af/at auto mode	When detecting an IEEE 802.3 af/at PD, the system suggests selecting 802.3 af/at Auto mode.
Select high power output	When detecting an unknown classification, the system suggests selecting High Power output.
Raise the external power supply voltage to greater than 46 VDC	When the external supply voltage is detected at less than 46 V, the system suggests raising the voltage.
Enable PoE function for detection	The system suggests enabling the PoE function.

Layer 2 Switching

This section describes how to configure various parameters, such as **VLAN**, **GARP**, **MAC**, **QoS**, and **Multicast**, for Moxa's switch. Click **Layer 2 Switching** on the function menu.

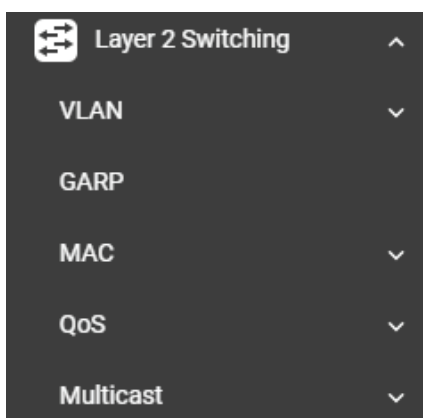

VLAN

VLAN (Virtual Local Area Network) is a network management technology where IEEE 802.11Q is widely applied.

IEEE 802.1Q Overview

The IEEE 802.1Q is a network communication protocol that falls under the IEEE 802.1 standard regulation, allowing various segments to use a physical network at the same time to block broadcast packets by different segmentations. It specifies the VLAN tagging for Ethernet frames on switches that can control the path process.

How A VLAN Works

What is a VLAN?

A VLAN is a group of devices that can be located anywhere on a network, but which communicate as if they are on the same physical segment. With VLANs, you can segment your network without being restricted by physical connections—a limitation of traditional network design. With VLANs you can segment your network into:

- **Departmental groups**—You could have one VLAN for the marketing department, another for the finance department, and another for the product development department.
- **Hierarchical groups**—You could have one VLAN for directors, another for managers, and another for general staff.
- **Usage groups**—You could have one VLAN for email users and another for multimedia users.

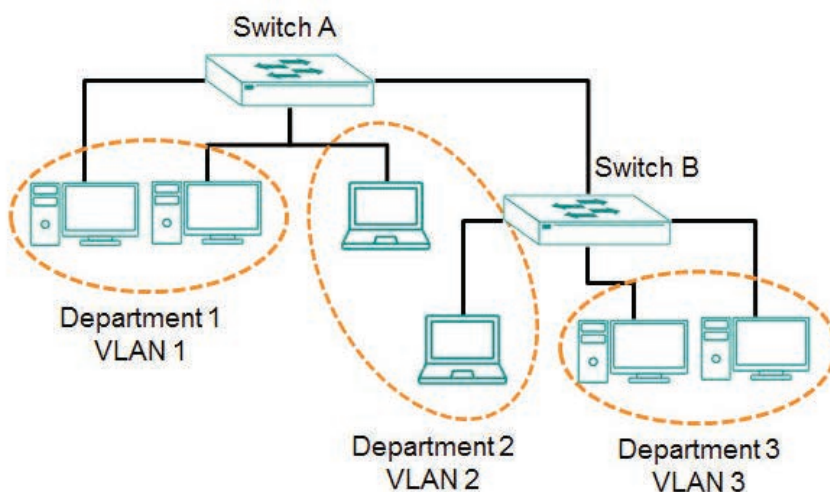

Benefits of VLANs

The main benefit of VLANs is that they provide a network segmentation system that is far more flexible than traditional networks. Using VLANs also provides you with three other benefits:

- **VLANs ease the relocation of devices on networks:** With traditional networks, network administrators spend much of their time dealing with changes. If users move to a different subnetwork, the addresses of each host must be updated manually. With a VLAN setup, if a host originally on the Marketing VLAN is moved to a port on another part of the network, and retains its original subnet membership, you only need to specify that the new port is on the Marketing VLAN. You do not need to do any re-cabling.
- **VLANs provide extra security:** Devices within each VLAN can only communicate with other devices on the same VLAN. If a device on the Marketing VLAN needs to communicate with devices on the Finance VLAN, the traffic must pass through a routing device or Layer 3 switch.
- **VLANs help control traffic:** With traditional networks, congestion can be caused by broadcast traffic that is directed to all network devices, regardless of whether or not they need it. VLANs increase the efficiency of your network because each VLAN can be set up to contain only those devices that need to communicate with each other.

VLANs and the Moxa switch

Your Moxa switch includes support for VLANs using IEEE Std 802.1Q-2005. This standard allows traffic from multiple VLANs to be carried across one physical link. The IEEE Std 802.1Q-2005 standard allows each port on your Moxa switch to be placed as follows:

- On a single VLAN defined in the switch
- On several VLANs simultaneously using 802.1Q tagging

The standard requires that you define the 802.1Q VLAN ID for each VLAN on your Moxa switch before the switch can use it to forward traffic:

Managing a VLAN

A new or initialized Moxa switch contains a single VLAN—the Default VLAN. This VLAN has the following definition:

- Management VLAN ID 1 can be changed
- 802.1Q VLAN default ID 1 cannot be deleted

All the ports are initially placed on this VLAN, and it is the only VLAN that allows you to access the management software of the Moxa switch over the network.

Communication Between VLANs

If devices connected to a VLAN need to communicate with devices on a different VLAN, a router or Layer 3 switching device with connections to both VLANs need to be installed. Communication between VLANs can only take place if they are all connected to a routing or Layer 3 switching device.

VLANs: Tagged and Untagged Membership

Moxa's switch supports 802.1Q VLAN tagging, a system that allows traffic for multiple VLANs to be carried on a single physical link (backbone, trunk). When setting up VLANs you need to understand when to use untagged or tagged membership of VLANs. Simply put, if a port is on a single VLAN it can be an untagged member, but if the port needs to be a member of multiple VLANs, a tagged membership must be defined.

A typical host (e.g., clients) will be an untagged member of one VLAN, defined as an **Access Port** in a Moxa switch, while an inter-switch connection will be a tagged member of all VLANs, defined as a **Trunk Port** in a Moxa switch.

The IEEE Std 802.1Q-2005 defines how VLANs operate within an open packet-switched network. An 802.1Q compliant packet carries additional information that allows a switch to determine which VLAN the packet belongs to. If a frame is carrying the additional information, it is known as a tagged frame.

To carry multiple VLANs across a single physical link (backbone, trunk), each packet must be tagged with a VLAN identifier so that the switches can identify which packets belong to which VLAN. To communicate between VLANs, a router must be used.

Moxa's switch supports three types of VLAN port settings:

- **Access Port:** The port connects to a single device that is not tagged. The user must define the default port PVID that assigns which VLAN the device belongs to. Once the ingress packet of this Access Port egresses to another Trunk Port (the port needs all packets to carry tag information), the switch will insert this PVID into this packet so the next 802.1Q VLAN switch can recognize it.
- **Trunk Port:** The port connects to a LAN that consists of untagged devices and tagged devices. In general, the traffic of the Trunk Port must have a Tag. Users can also assign a PVID to a Trunk Port. The untagged packet on the Trunk Port will be assigned the default port PVID as its VID.
- **Hybrid Port:** The port is similar to a Trunk port, except users can explicitly assign tags to be removed from egress packets.

The following section illustrates how to use these ports to set up different applications.

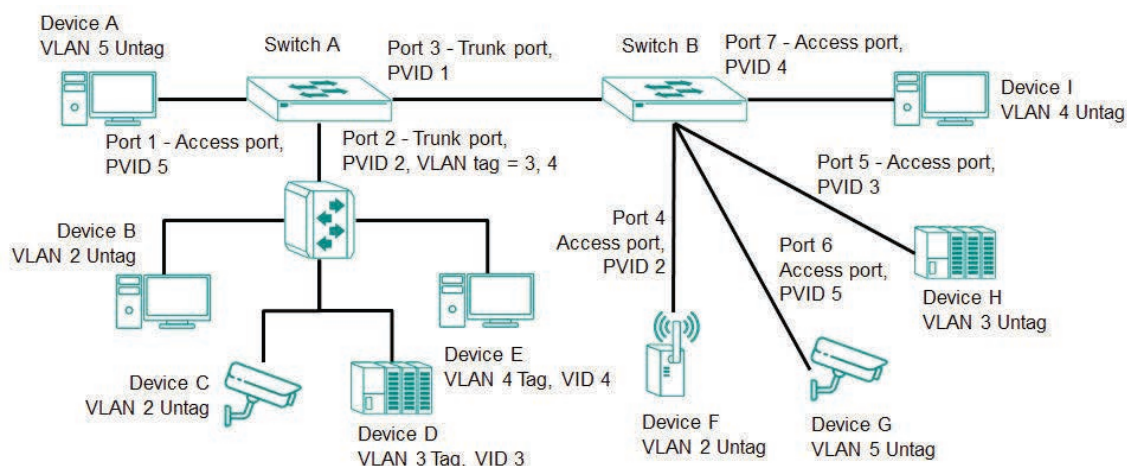

In this application:

- Port 1 connects a single untagged device and assigns it to VLAN 5; it should be configured as an **Access Port** with PVID 5.
- Port 2 connects a LAN with two untagged devices belonging to VLAN 2. One tagged device with VID 3 and one tagged device with VID 4. It should be configured as a **Hybrid Port** with PVID 2 for untagged device and Fixed VLAN (Tagged) with 3 and 4 for tagged device. Since each port can only have one unique PVID, all untagged devices on the same port must belong to the same VLAN.
- Port 3 connects with another switch. It should be configured as a **Trunk Port**. GVRP protocol will be used through the Trunk Port.
- Port 4 connects a single untagged device and assigns it to VLAN 2; it should be configured as an **Access Port** with PVID 2.
- Port 5 connects a single untagged device and assigns it to VLAN 3; it should be configured as an **Access Port** with PVID 3.
- Port 6 connect a single untagged device and assigns it to VLAN 5; it should be configured as an **Access Port** with PVID 5.
- Port 7 connects a single untagged device and assigns it to VLAN 4; it should be configured as an **Access Port** with PVID 4.

After the application is properly configured:

- Packets from Device A will travel through **Trunk Port 3** with tagged VID 5. Switch B will recognize its VLAN, pass it to port 6, and then remove tags received successfully by Device G, and vice versa.
- Packets from Devices B and C will travel through **Hybrid Port 2** with tagged VID 2. Switch B recognizes its VLAN, passes it to port 4, and then removes tags received successfully by Device F, and vice versa.
- Packets from Device D will travel through **Trunk Port 3** with tagged VID 3. Switch B will recognize its VLAN, pass to port 5, and then remove tags received successfully by Device H. Packets from Device H will travel through **Trunk Port 3** with PVID 3. Switch A will recognize its VLAN and pass it to port 2, but will not remove tags received successfully by Device D.
- Packets from Device E will travel through **Trunk Port 3** with tagged VID 4. Switch B will recognize its VLAN, pass it to port 7, and then remove tags received successfully by Device I. Packets from Device I will travel through **Trunk Port 3** with tagged VID 4. Switch A will recognize its VLAN and pass it to port 2, but will not remove tags received successfully by Device E.

VLAN Settings

To configure VLAN, click **VLAN** on the function menu. GVRP (Generic VLAN Registration Protocol) is an IEEE 802.1Q standard protocol that helps specify how to define a method of tagging frames with VLAN configuration data. It essentially facilitates management of VLAN within a larger network data communication.

To edit the GVRP function, click the **Global** tab.

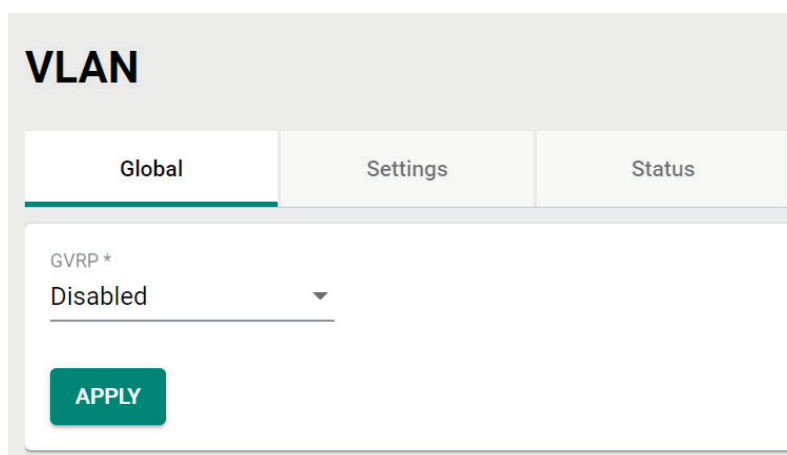

The screenshot shows the 'VLAN' configuration page. At the top, there are three tabs: 'Global', 'Settings', and 'Status'. The 'Global' tab is currently selected and highlighted with a green underline. Below the tabs, there is a dropdown menu labeled 'GVRP *' with 'Disabled' selected. A green 'APPLY' button is located below the dropdown menu.

Configure the following setting.

GVRP

Setting	Description	Factory Default
Disabled	Disables GVRP.	Disabled
Enabled	Enables GVRP.	

Click **APPLY** to finish.

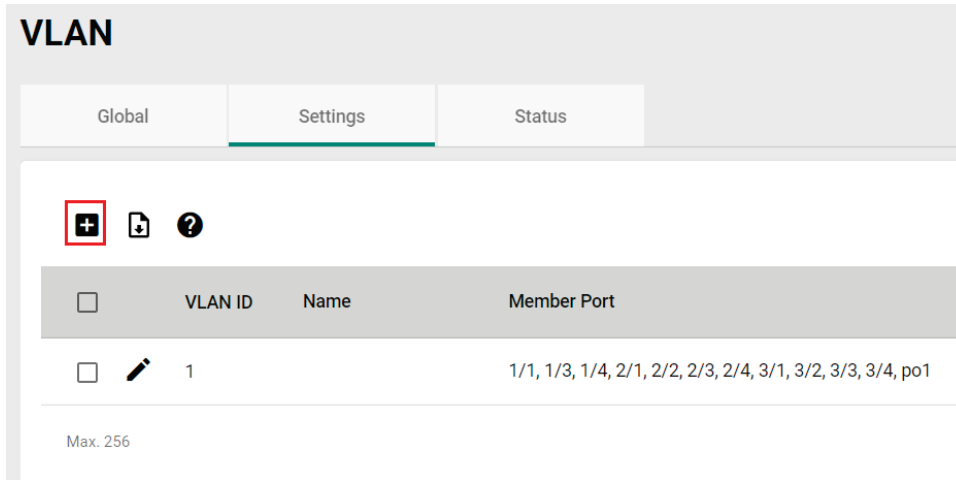

Detailed VLAN Settings

Click the **Settings** tab, and then click the  icon.



VLAN

Global Settings Status

<input type="checkbox"/>	VLAN ID	Name	Member Port
<input type="checkbox"/>	1		1/1, 1/3, 1/4, 2/1, 2/2, 2/3, 2/4, 3/1, 3/2, 3/3, 3/4, po1

Max. 256

Configure the following parameters.

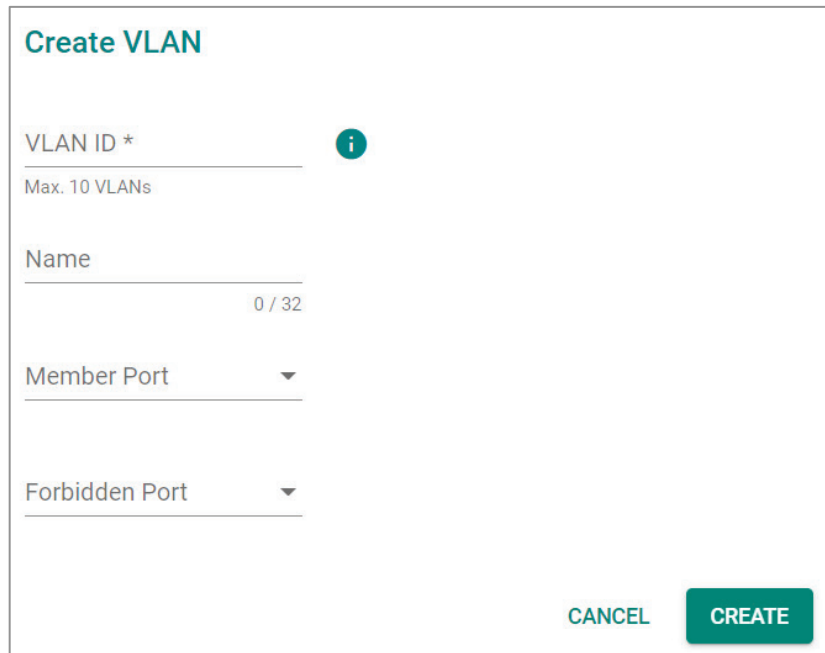

Create VLAN

VLAN ID * 
Max. 10 VLANs

Name
0 / 32

Member Port ▼

Forbidden Port ▼

CANCEL CREATE

VLAN ID

Setting	Description	Factory Default
Input a VLAN ID, (10 VLANs max.)	Input a VLAN ID.	None

Name

Setting	Description	Factory Default
Input a name for the VLAN, (32 characters max.)	Specify a name for the VLAN.	None

Member Port

Setting	Description	Factory Default
Select the port from the drop-down list.	Specify the ports that are the member ports for the VLAN.	None

Forbidden Port (in Advanced Mode only)

Setting	Description	Factory Default
Select the port from the drop-down list	Specify the ports that are forbidden for the VLAN.	None



When finished, click **CREATE**.

Editing the Existing VLAN Settings

To edit the existing VLAN settings, click the  icon of the VLAN you want to edit.

VLAN

Global Settings Status

<input type="checkbox"/>	VLAN ID	Name	Member Port
<input type="checkbox"/>	1		1/1, 1/3, 1/4, 2/1, 2/2, 2/3, 2/4, 3/1, 3/2, 3/3, 3/4, po1

Max. 256

Configure the following settings.

Edit VLAN 1 Settings

VLAN ID
1
Max. 10 VLANs

Name
0 / 32

Member Port
1/1, 1/3, 1/4, 2/1, 2/2...

Forbidden Port

CANCEL APPLY

VLAN ID

Setting	Description	Factory Default
Show the VLAN ID	Display the VLAN ID.	None

Name

Setting	Description	Factory Default
Show the name of the VLAN	Display the VLAN name.	None

Member Port

Setting	Description	Factory Default
Select the port from the drop-down list	Specify the ports that are member ports for the VLAN.	None



Forbidden Port (in Advanced Mode only)

Setting	Description	Factory Default
Select the port from the drop-down list	Specify the ports that are forbidden for the VLAN.	None

When finished, click **Apply** to save your changes.

Editing the Port Settings

To edit the port settings, in the **VLAN** tab select the  icon on the port you want to configure on the lower part of the page.

Port	Mode	PVID	GVRP	Untagged VLAN	Tagged VLAN
 1/1	Access	1	Disabled	1	
 1/3	Access	1	Disabled	1	
 1/4	Access	1	Disabled	1	

Configure the following settings.

Edit Port 1/1 Settings

Mode *
Access

PVID *
1

GVRP
Disabled

Tagged VLAN

Untagged VLAN
All Member VLAN IDs

Copy Configurations ... 

CANCEL APPLY

Mode

Setting	Description	Factory Default
Access	When this port is connected to a single device, without tags.	Access
Trunk	When this port is connected to another 802.1Q VLAN aware switch.	
Hybrid	When this port is connected to another Access 802.1Q VLAN aware switch or another LAN that combines tagged and/or untagged devices.	

PVID

Setting	Description	Factory Default
1 to 4094	Sets the default VLAN ID for untagged devices connected to the port.	None

GVRP

Setting	Description	Factory Default
Enabled	Enables GVRP.	Disabled
Disabled	Disables GVRP.	

Tagged VLAN

Setting	Description	Factory Default
1 to 4094	This field will be active only when selecting the Trunk or Hybrid port type. Set the other VLAN ID for tagged devices that connect to the port.	None

Untagged VLAN

Setting	Description	Factory Default
VID range from 1 to 4094	This field is only active when the Hybrid port type is selected. Set the other VLAN ID for tagged devices that connect to the port and tags that need to be removed in egress packets.	1

Copy Configurations to Ports

Setting	Description	Factory Default
Select the port(s) from the drop-down list	Copy the configuration to other port(s).	None

When finished, click **APPLY** to save your changes.

Deleting an Existing VLAN

In Settings tab, check the VLAN you want to delete, and click the delete icon  .

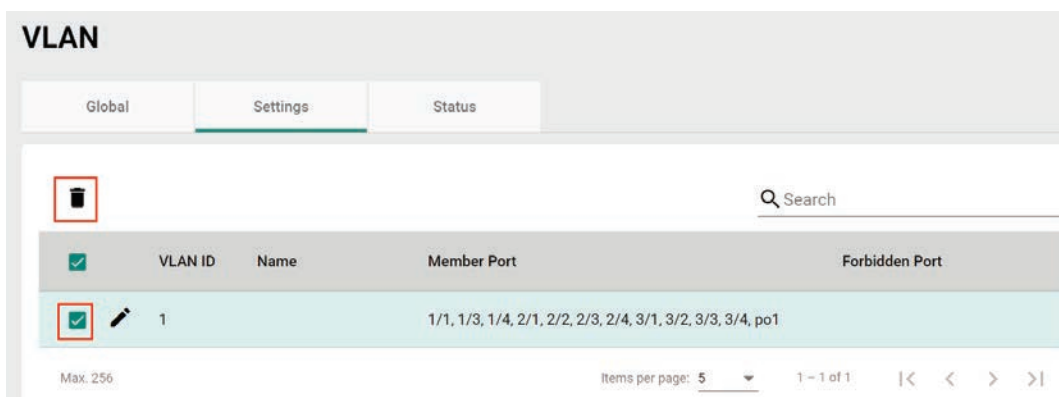

The screenshot shows the 'VLAN' configuration page with the 'Settings' tab selected. At the top, there are tabs for 'Global', 'Settings', and 'Status'. Below the tabs is a search bar and a table of VLANs. The table has columns for 'VLAN ID', 'Name', 'Member Port', and 'Forbidden Port'. A single row is visible with 'VLAN ID' 1, 'Name' (empty), 'Member Port' '1/1, 1/3, 1/4, 2/1, 2/2, 2/3, 2/4, 3/1, 3/2, 3/3, 3/4, po1', and 'Forbidden Port' (empty). A delete icon (trash can) is highlighted in a red box in the top left corner of the table area. At the bottom of the table, there is a 'Max. 256' label, 'Items per page: 5', and '1 - 1 of 1' with navigation arrows.

Click **DELETE** to delete the VLAN.

Delete VLAN

Are you sure you want to delete the selected VLAN?



CANCEL **DELETE**

GARP Overview

GARP stands for **Generic Attribute Registration Protocol**, which is a communication protocol defined by IEEE 802.1, offering a generic framework for bridges to register and de-register an attribute value. In a VLAN structure, two applications can be applied: **GARP VLAN Registration Protocol (GVRP)** is used to register VLAN trunking between switches, and **GARP Multicast Registration Protocol (GMRP)** for providing a constrained multicast flooding facility.

GARP Settings

Select **GARP** on the menu page, and then click the  icon on the port you want to configure.

	Port	Join Time	Leave Time	Leave All Time
	1/1	200	600	10000
	1/3	200	600	10000
	1/4	200	600	10000

Configure the following settings.

Edit Port 1/1 Settings

Join Time *
200
10 - 1073741810

Leave Time *
600
30 - 2147483630

Leave All Time *
10000
40 - 2147483640

Copy Configurations ... 

CANCEL **APPLY**

Join Time (sec.)

Setting	Description	Factory Default
10 to 499999980	Input the join time from 10 to 499999980 seconds.	200

Leave Time (sec.)

Setting	Description	Factory Default
30 to 499999980	Input the leave time from 30 to 499999980 seconds.	600

Leave All time (sec.)

Setting	Description	Factory Default
30 to 499999990	Input the leave all time.	10000

Copy Configurations to Ports

Setting	Description	Factory Default
Select the port(s) from the drop-down list	Copy the configurations to other port(s).	None

When finished, click **APPLY** to save your changes.

MAC

This section explains Independent VLAN learning and describes how to configure **Static Unicast** and the **MAC Address Table**.

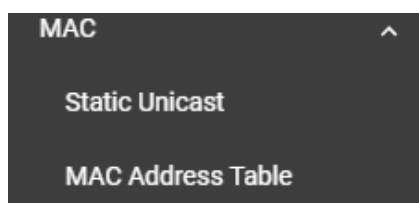

Independent VLAN Learning

Moxa's switch uses the **Independent VLAN Learning (IVL)** mode.

In an **IVL Mode**, a MAC table will be created in each VLAN, which will constitute many MAC tables. However, the same VID record will be selected and put in a table. A MAC table will be stored in the format of MAC + VID, the same MAC will be stored in different tables with different VIDs.

Static Unicast

Click **Static Unicast** on the function menu page and click  icon on the configuration page.

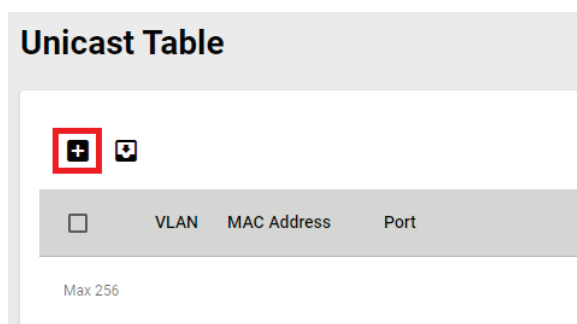

Configure the following settings.

Add Static Unicast Entry

VLAN ID * MAC Address *

Port *

CANCEL CREATE

VLAN ID

Setting	Description	Factory Default
Input a VLAN ID	Input a VLAN ID for this entry.	None

MAC Address

Setting	Description	Factory Default
Input a MAC address	Input the MAC address of the connecting device.	None

Port

Setting	Description	Factory Default
Select the port from the drop-down list	Select the port on the switch.	None

When finished, click **CREATE**.

MAC Address Table

Select **MAC Address Table** and configure the following settings.

MAC Address Table

MAC Learning Mode
Independent VLAN Learning

Aging Time *

300

10 - 300 sec.

APPLY

MAC Learning Mode

Information	Description	Factory Default
Independent VLAN learning	Show the current MAC Learning Mode.	Independent VLAN learning

Aging Time

Setting	Description	Factory Default
10 to 300	Specify the aging time for MAC address entries (in seconds).	None

When finished, click **APPLY** to save your changes.

You can view the current MAC Address Table on the bottom part of the configuration page.

Index	VLAN	MAC Address	Type	Port
1	1	c8:cb:b8:02:26:5f	Learnt Unicast	3/4

Item Name	Description
Index	The number of the MAC address.
VLAN	The VLAN number
MAC Address	The MAC address on this device.
Type	Learnt Unicast, Learnt Multicast, Static Unicast, Static Multicast
Port	The forwarding port of this MAC address.

QoS

This section describes how QoS works and how to configure the settings.

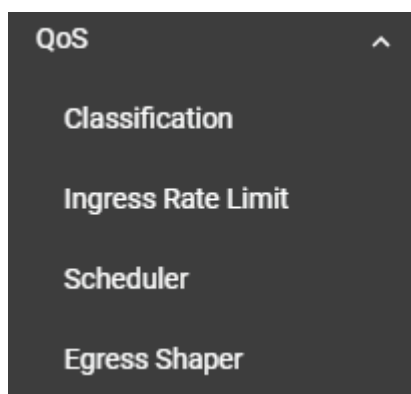

QoS Overview

The switch's traffic prioritization capability provides Quality of Service (QoS) to your network by making data delivery more reliable. You can prioritize traffic on your network to ensure that high priority data is transmitted with minimum delay. Traffic can be controlled by a set of rules to obtain the required Quality of Service for your network. The rules define different types of traffic and specify how each type should be treated as it passes through the switch. The switch can inspect both IEEE 802.1p/1Q layer 2 CoS (Class of Service) tags, and even layer 3 DSCP (Differentiated Services Code Point) information to provide consistent classification of the entire network. The switch's QoS capability improves the performance and determinism of industrial networks for mission-critical applications.

The Traffic Prioritization Concept

Traffic prioritization allows you to prioritize data so that time-sensitive and system-critical data can be transferred smoothly and with minimal delay over a network. The benefits of using traffic prioritization are:

- Improve network performance by controlling a wide variety of traffic and by managing congestion.
- Assign priorities to different categories of traffic. For example, set higher priorities for time-critical or mission-critical applications.
- Provide predictable throughput for multimedia applications, such as video conferencing or voice over IP, and minimize traffic delay and jitter.
- Optimize the network utilization depending on application usage and usage needs. Hence, asset owners do not always need to expand their backbone bandwidth as the amount of traffic increases.

Traffic prioritization uses eight traffic queues to ensure that higher priority traffic can be forwarded separately from lower priority traffic, which guarantees Quality of Service (QoS) to your network.

Moxa switch traffic prioritization is based on two standards:

- **IEEE 802.1p**—a layer 2 QoS marking scheme
- **Differentiated Services (DiffServ)**—a layer 3 QoS marking scheme.

IEEE 802.1p Class of Service

The IEEE Std 802.1D 2005 Edition marking scheme, which is an enhancement to IEEE Std 802.1D, enables Quality of Service on the LAN. Traffic service levels are defined in the IEEE 802.1Q 4-byte tag, which is used to carry VLAN identification as well as IEEE 802.1p priority information. The IEEE 802.1p occupying 3 bits of the tag follows the destination MAC address and Source MAC address.

The IEEE Std 802.1D 2005 Edition priority marking scheme assigns an IEEE 802.1p priority level between 0 and 7 to each frame, which specifies the level of service that the associated packets shall be handled. The table below shows an example of how different traffic types can be mapped to the eight IEEE 802.1p priority levels.

IEEE 802.1p Priority Level	IEEE 802.1D Traffic Type
0	Best Effort
1	Background (lowest priority)
2	Reserved
3	Excellent Effort (business critical)
4	Controlled Load (streaming multimedia)
5	Video (interactive media)
6	Voice (interactive voice)
7	Network Control Reserved traffic

Even though the IEEE 802.1p standard is the most widely used prioritization scheme for LAN environments, it still has some restrictions:

- It requires an additional 4-byte tag in the frame, which is normally optional for Ethernet networks. Without this tag, the scheme cannot work.
- The tag is part of the IEEE 802.1Q header, so to implement QoS at layer 2, the entire network must implement IEEE 802.1Q VLAN tagging.
- It is only supported within a LAN and does not cross the WAN boundaries, since the IEEE 802.1Q tags will be removed when the packets pass through a router.

Differentiated Services (DiffServ) Traffic Marking

DiffServ is a Layer 3 marking scheme that uses the DiffServ Code Point (DSCP) field in the IP header to specify the packet priority. DSCP is an advanced intelligent method of traffic marking that allows you to choose how your network prioritizes different types of traffic. The DSCP field can be set from 0 to 63 to map to user-defined service levels, enabling users to regulate and categorize traffic by applications with different service levels.

The advantages of DiffServ over IEEE 802.1Q are as follows:

- You can prioritize and assign different traffic with appropriate latency, throughput, or reliability by each port.
- No extra tags are required.
- The DSCP priority tags are carried in the IP header, which can pass the WAN boundaries and through the Internet.
- DSCP is backwards compatible with IPv4 ToS (Type of Service), which allows operation with legacy devices that use IPv4 layer 3.

Traffic Prioritization

Moxa switches classify traffic based on layer 2 of the OSI 7 layer model, and the switch prioritizes outbound traffic according to the priority information defined in the received packet. Incoming traffic is classified based upon the IEEE 802.1p service level field and is assigned to the appropriate egress priority queue. The traffic flow through the switch is as follows:

- A packet received by the Moxa switch may or may not have an 802.1p tag associated with it. If it does not, then it is given a default CoS value (according to the port settings in the classification section). Alternatively, the packet might be marked with a new 802.1p value, which will result in all knowledge of the previous 802.1p tag being lost.
- Each egress queue has associated 802.1p priority levels, and can be defined by users, the packet will be placed in the appropriate priority queue. When the packet reaches the head of its queue and is about to be transmitted, the device determines whether or not the egress port belongs to the VLAN group. If it is, then the new 802.1p tag is used in the extended 802.1D header.

Traffic Queues

The hardware of Moxa switches has multiple traffic queues that allow packet prioritization to occur. Higher priority traffic can pass through the Moxa switch without being delayed by lower priority traffic. As each packet arrives in the Moxa switch, it undergoes ingress processing (which includes classification, marking/re-marking), and is then sorted into the appropriate queue. The switch then forwards packets from each queue.

Moxa switches support two different queuing mechanisms:

- **Weight Fair:** This method services all the traffic queues, giving priority to the higher priority queues. Under most circumstances, the Weight Fair method gives high priority precedence over low priority, but in the event that high priority traffic does not reach the link capacity, lower priority traffic is not blocked.
- **Strict:** This method services high traffic queues first; low priority queues are delayed until no more high priority data needs to be sent. The Strict method always gives precedence to high priority over low priority.





Classification

There are three parameters in this section: **DSCP Mapping**, **CoS Mapping**, and **Port Setting**. The three parameters are described below in detail.

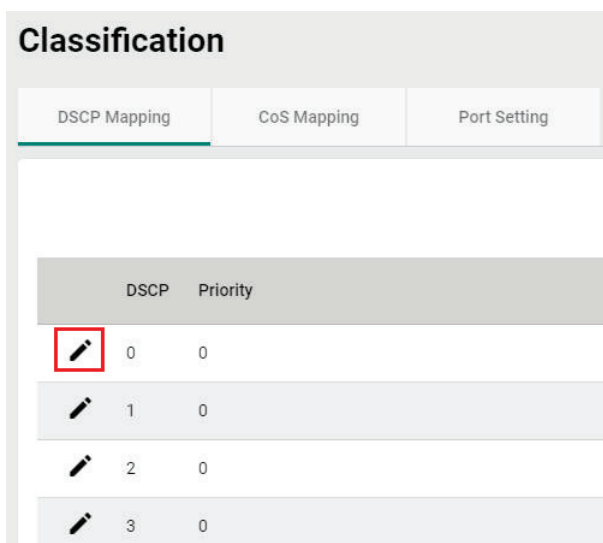
DSCP to CoS Mapping

In the **Classification** menu, click the **DSCP Mapping** tab, and then click  icon.



	DSCP	Priority
	0	0
	1	0
	2	0
	3	0

Configure the priority setting from the drop-down list.

Edit DSCP 0 Setting

CoS-Priority *

0 ▼

CANCEL
APPLY

DSCP Value and Priority

Setting	Description	Factory Default
0 to 7	Different DSCP values map to one of eight different priorities from 0 to 7.	0
8 to 15		1
16 to 23		2
24 to 31		3
32 to 39		4
40 to 47		5
48 to 55		6
56 to 63		7

When finished, click **APPLY** to save your changes.

CoS to Queue Mapping





In the **Classification** menu, click the **CoS Mapping** tab, and then click  icon.

Classification

DSCP Mapping

CoS Mapping

Port Setting

	CoS	Queue
	0	1
	1	2
	2	3
	3	4

Configure the Queue priority setting.

Edit CoS 0 Setting

Queue *

1 ▼

CANCEL
APPLY

Queue Priority





Setting	Description	Factory Default
0	Different 802.1p values map to one of the eight different queues from 1 (lowest priority) to 8 (highest).	1
1		2
2		3
3		4
4		5
5		6
6		7
7		8

Port Settings

In the **Classification** menu, click the **Port Setting** tab, and then click  icon.

Classification

DSCP Mapping
CoS Mapping
Port Setting

	Port	Trust Type	Priority
	1/1	CoS	3
	1/2	CoS	3
	1/3	CoS	3
	1/4	CoS	3

Configure the following settings.

Edit Port 1/1 Settings

Trust Type *
CoS ▼

Untag Default Priority *
3 ▼

Copy Configurations ... ▼ 

CANCEL
APPLY

Trust Type

Setting	Description	Factory Default
CoS	Enables the port with CoS-based traffic classification.	CoS
DSCP	Enables the port with DSCP-based traffic classification.	

Untag Default Priority

Setting	Description	Factory Default
0 to 7	802.1p tag (CoS) can be range from 0 (lowest) to 7 (highest).	3



NOTE

Certain functions such as redundancy mechanisms use the highest traffic class. Therefore, assign an another traffic class to application data for the EDS-(G)4000 Series.

Copy Configurations to Ports

Setting	Description	Factory Default
Select from the drop-down list	Copy the settings to other ports you select.	None

When finished, click **APPLY** to save your changes.

Ingress Rate Limit

Ingress Rate Limit Overview

The rate limit is composed of the meter and the marker. The meter is the monitoring of the data rates for a particular class of traffic. When the data rate exceeds user-configured values, marking or dropping of packets occurs immediately. The meter does not buffer the traffic; therefore, the transmission delay is not affected. When traffic exceeds the user's specified value, you can instruct the system to either drop the packets or mark QoS fields in them. The meter algorithms include simple token bucket and SrTCM (Single Rate Three Color Marker) (RFC2697). The marker of the rate limit is included and remarked in the 802.1p or the DSCP field of the packet.

Simple Token Bucket

The Token Bucket Concept

Token Bucket is an algorithm used to achieve efficient network flow control and to manage bandwidth. This algorithm is based on a token bucket that allows for a traffic surge for short periods. When a token is unavailable, no burst of packets can be sent. Under this concept, the number of tokens will be refilled in the bucket at specific intervals. Users need to configure these settings so that the tokens in the bucket are always available to ensure packets can be sent when necessary.

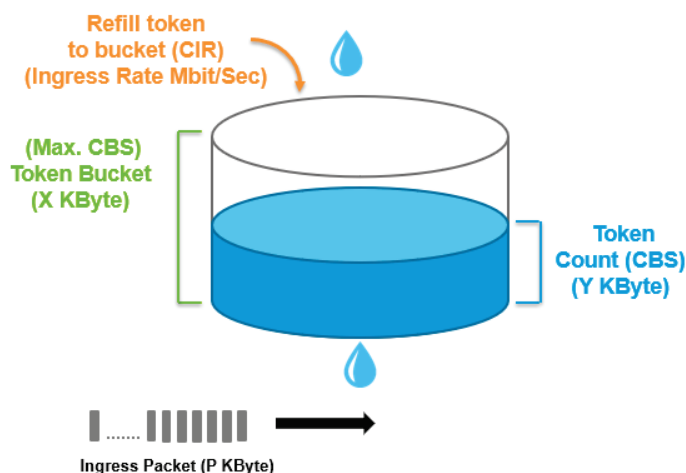

CAR (Committed Access Rate) is a traffic control mechanism used to ensure that packets meet the network rules before they enter the network. CAR can guarantee the traffic flow is under user-defined control; the packets exceeding the rule will be either dropped or remarked and transmitted again. When network traffic is jammed, these packets will be dropped first.

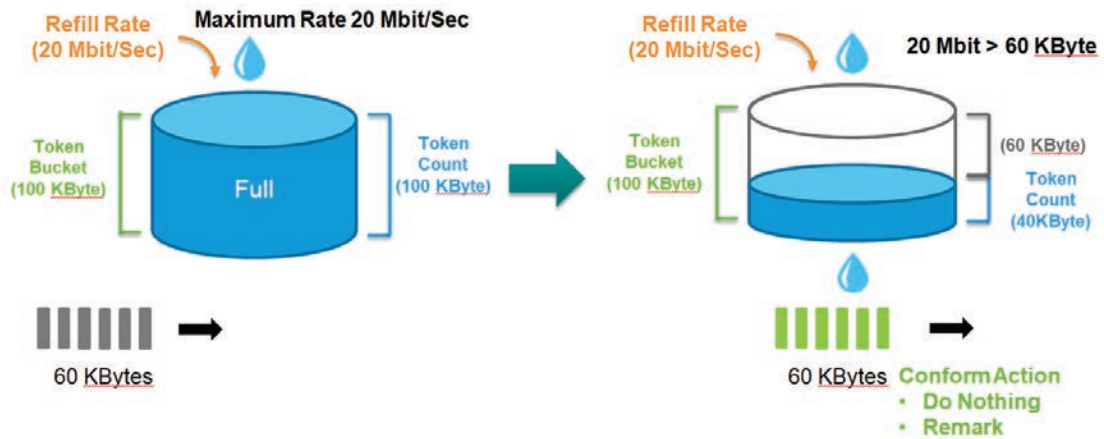

Token Bucket is an algorithm that is demonstrated as a container in the image below. The token can be seen as a marker to mark a packet that is allowed to be transmitted through this switch. When the token is flowing into the bucket, the length of the bucket will be consumed as the volume of the bucket is limited. When the volume of the bucket is insufficient, some packets will be dropped or remarked and transmitted again. This algorithm can control the speed of the traffic flow by consuming the speed of the token in the bucket.

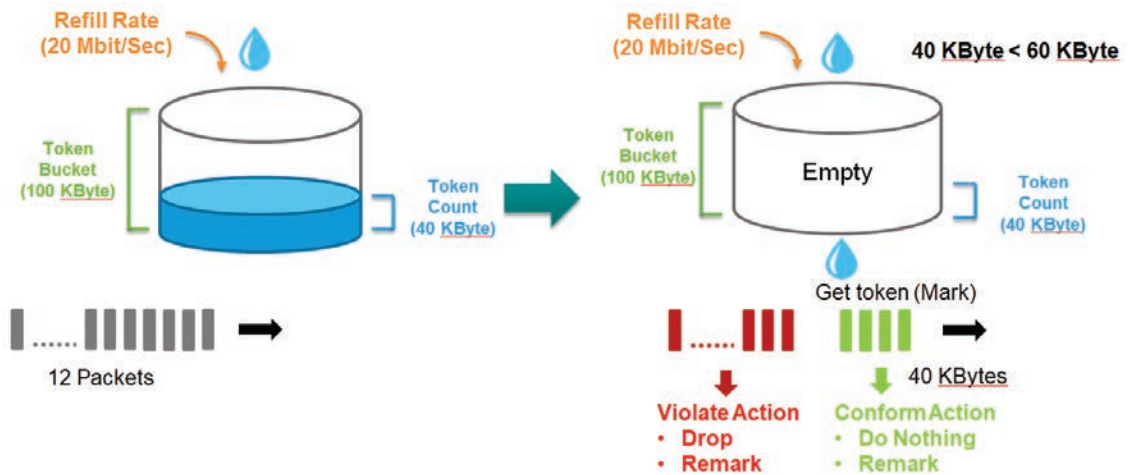

Simple Token Bucket Concept

In the Simple Token Bucket algorithm, two methods will be used:

CIR: Committed Information Rate: Users can pre-configure the CIR, which specifies the amount of data that can be sent per unit time interval. When tokens are unavailable, the packets will not be sent until the tokens are added into the bucket. This guarantees sufficient network bandwidth and efficient flow control.

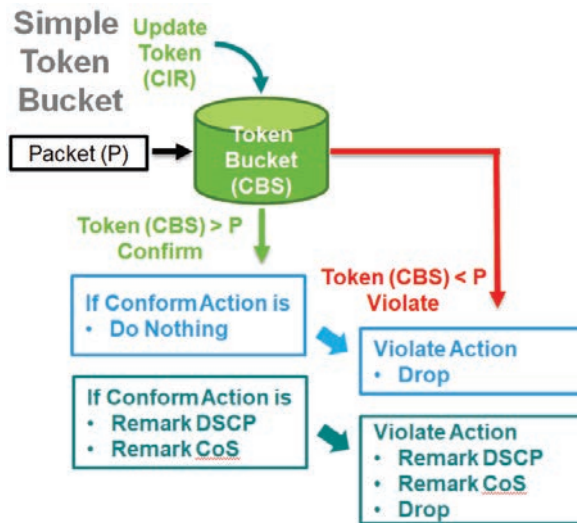

SrTCM (Single Rate Three Color Marker)

SrTCM Overview

SrTCM stands for A Single Rate Three Color Marker, which is another policing scheme for ingress rate limit. Traffic marking is based on a Committed Information Rate (CIR) and two associated burst sizes, a Committed Burst Size (CBS) and an Excess Burst Size (EBS). A packet is marked green if it does not exceed the CBS, yellow if it does exceed the CBS, but not the EBS, and red otherwise.

How SrTCM Works

Single Rate Three Color Markers (SrTCM) is a policing scheme for ingress rate limits.

Traffic marking is based on a Committed Information Rate (CIR) and two associated burst sizes:

- Committed Burst Size (CBS)
- Excess Burst Size (EBS)

A packet is marked green if it does not exceed the CBS, yellow if it exceeds the CBS but not the EBS, and red otherwise.

SrTCM will categorize the ingress packet by its length, and mark it as one of three colors:

- **Green:** Performs the "conform" action. It could be "Do nothing", "Remark DSCP", or "Remark CoS". The Token Bucket (CBS) will deduct corresponding tokens.
- **Yellow:** Performs the "exceed" action. It could be "Drop", "Remark DSCP", or "Remark CoS". The Token Bucket (EBS) will deduct corresponding tokens.
- **Red:** Performs the "violate" action. It could be "Drop", "Remark DSCP", or "Remark CoS".

If you select "Do nothing" as the conform action, then "Drop" will be the only action when it enters the "Exceed" or "Violate" state.

The SrTCM is useful for ingress policing of a service, where only the length, not the peak rate, of the burst determines service eligibility.

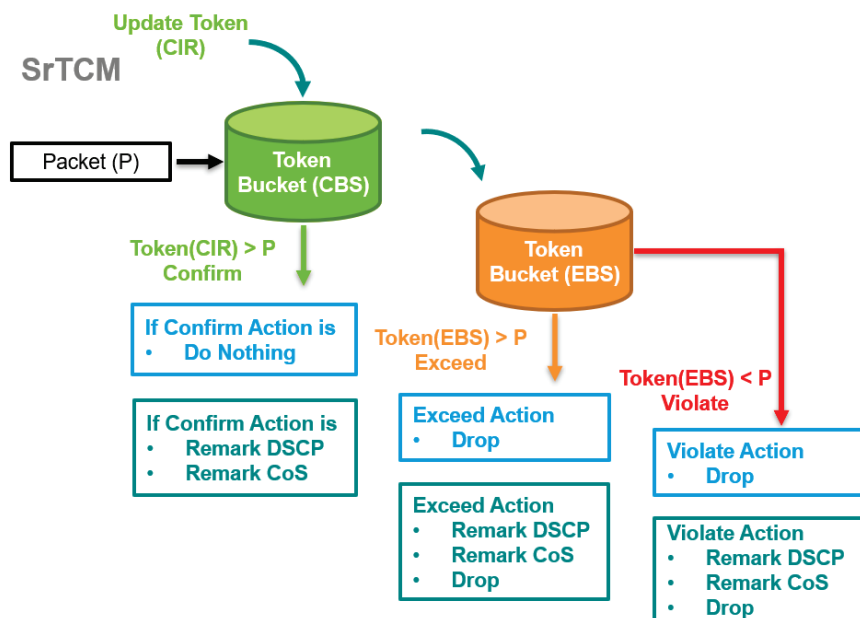

Exceed Rate Limit Threshold Port Shutdown

In general, any user shall not consume unlimited bandwidth and influence others' access. One particular scenario is that a malfunctioning switch or mis-configured network might cause "broadcast storms". Moxa industrial Ethernet switches not only prevent broadcast storms, but can also regulate ingress packet rates, giving administrators full control of their limited bandwidth to prevent undesirable effects caused by unpredictable faults.

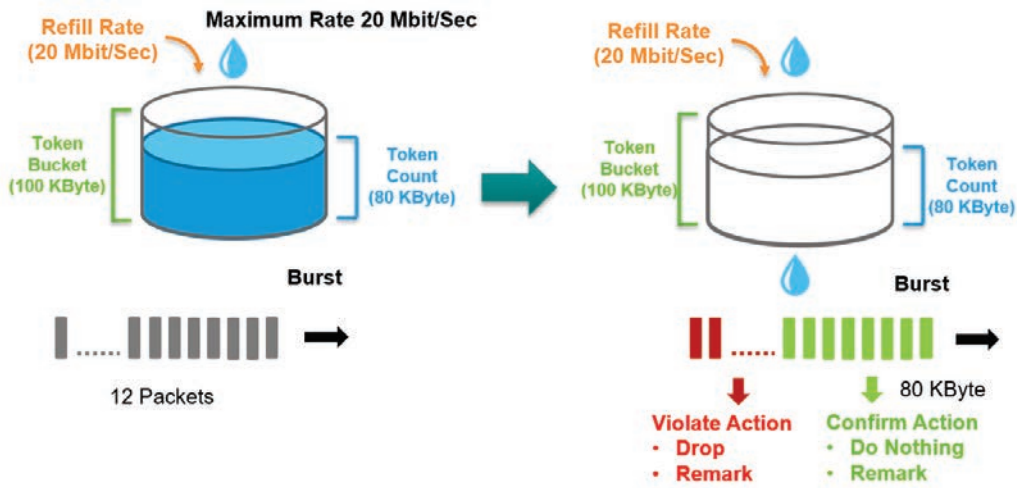

Editing Ingress Rate Limit

Switch to **Advanced Mode** before configuring the settings in this section.

On the **Ingress Rate Limit** menu, click the **General** tab, and then click  icon.







NOTE

The **General** tab settings are not available for the EDS-(G)4000 Series.

Ingress Rate Limit

General | Port Shutdown

Search

Port	Type	Ingress Rate (CIR)	CBS	EBS	Mode	Confirm Action	Exceed Action	Violate Action	
	1/1	Simple Token Bucket	1000	1024	1024	Color-Blind	Do Nothing	Drop	Drop
	1/2	Simple Token Bucket	1000	1024	1024	Color-Blind	Do Nothing	Drop	Drop
	1/3	Simple Token Bucket	1000	1024	1024	Color-Blind	Do Nothing	Drop	Drop
	1/4	Simple Token Bucket	1000	1024	1024	Color-Blind	Do Nothing	Drop	Drop

Configure the following settings.

Edit Port 1/1 Settings

Type *

Simple Token Bucket ▾

Ingress Rate (CIR) *

10000

1 - 10000 Mbps

CBS *

1024

10 - 10240 KByte

Conform Action *

Do Nothing ▾

Violate Action *

Drop ▾

Copy Configurations ... ▾ 

CANCEL APPLY

Type

Setting	Description	Factory Default
Simple Token Bucket	Specify Simple Token Bucket as Ingress Limit type.	Simple Token Bucket
SrTCM	Specify SrTCM as Ingress Limit type.	

Ingress Rate (CIR) (Mbps)

Setting	Description	Factory Default
1 to 1000	Define the specific incoming data communication speed given to this port.	1000

CBS (Committed Burst Size) (Kbyte)

Setting	Description	Factory Default
0 to 10240	Input the specific data buffer size given to this port when the data rate exceeds the CIR rate. The data that exceeded the CIR rate will be saved in temporary storage, and will be sent when bandwidth is available.	1024

EBS (Excess Burst Size) (Kbyte)

Setting	Description	Factory Default
0 to 10240	Input the specific data communication speed given to this port when the data rate exceeds the CIR rate. The data that exceeded the CIR rate will be saved in temporary storage, and will be sent when bandwidth is available.	1024

Conform Action

Setting	Description	Factory Default
Do Nothing	Do nothing.	Do Nothing
Remark CoS	Remark the CoS value.	
Remark DSCP	Remark the DSCP value.	

Violate Action

Setting	Description	Factory Default
---------	-------------	-----------------

Drop	Drop the packet if the packet violates CIR and CBS.	Drop
Remark CoS	Remark the CoS value if the packet is marked as violated.	
Remark DSCP	Remark the DSCP value if the packet is marked as violated.	

Copy Configurations to Ports

Setting	Description	Factory Default
Select the port(s) from the drop-down list	Copy the configurations to other port(s).	None

When finished, click **APPLY** to save your changes.

Editing Port Shutdown

To edit port shutdown settings for the RKS-G4000 Series, MDS-G4000 Series, and MDS-G4000-4XG Series, click the **Port Shutdown** tab.

Ingress Rate Limit

General | **Port Shutdown**

Port Shutdown *
Disabled

Release Interval *
60
0 - 10080 min.

APPLY

The EDS-(G)4000 Series does not support the **General** tab settings for the Ingress Rate Limit function. The **Port Shutdown** settings are shown by default.

Ingress Rate Limit

Rate Limit Port Shutdown *
Disabled

Release Interval *
60
0 - 10080 min.

APPLY

Configure the following settings.

Port Shutdown

Setting	Description	Factory Default
Enable	Enable the port to be shut down.	Disabled
Disable	Disable the ability for the port to be shut down.	





Release Interval (min.)

Setting	Description	Factory Default
0 to 10080	Specify the duration to wait (in minutes) before a shut-down port is enabled again. 0 means if this port is shut down, it will remain shut down until manually enabled.	60

When finished, click **APPLY** to save your changes.

Editing the Port for Port Shutdown

Edit the specific port that you want to edit the port shutdown configurations for.

	Port	Enable	Threshold (Mbps)
	1/1	Disabled	1000
	1/2	Disabled	1000
	1/3	Disabled	1000
	1/4	Disabled	1000

Configure the following settings.

Edit Port 1/1 Settings

Port Shutdown *
 Disabled ▼

Threshold *
 10000

1 - 10000 Mbps

Copy Configurations ... ▼ 

CANCEL APPLY

Port Shutdown

Setting	Description	Factory Default
Enable	Enable port shutdown for this port.	Disable
Disable	Disable port shutdown for this port.	

Threshold (Mbps)

Setting	Description	Factory Default
1 to 1000	Specify the threshold for port shutdown	1000

Copy Configuration to Ports

Setting	Description	Factory Default
Select the port(s) from the drop-down list	Copy the configurations to other port(s).	None

When finished, click **APPLY** to save your changes.

Scheduler

Scheduler Overview

Scheduler is an arbiter in switch forwarding path to prioritize traffic flows by users' defined criteria. This essentially enhances data transmission efficiency and guarantees that critical packets can be transmitted earlier. Moxa's switches support two scheduling algorithms: Strict Priority and Weighted Round Robin.

Strict Priority

The Strict Priority type allows users to determine to transmit packets in the highest priority queue first, while packets with lower priority will be transmitted later. This guarantees that traffic with the highest level of priority for data transmission will go first.

Weighted Round Robin

The Weighted Round Robin type allows users to give priority to specific packets in the higher weighted queue to ensure those packets will be sent first. For Moxa switches with 8 queues, the weights from highest to lowest are 8:8:4:4:2:2:1:1. For Moxa switches with 4 queues, the weights from highest to lowest are 8:4:2:1.

Scheduler Settings

Select Scheduler in the menu and then click the  icon on the port you want to configure.

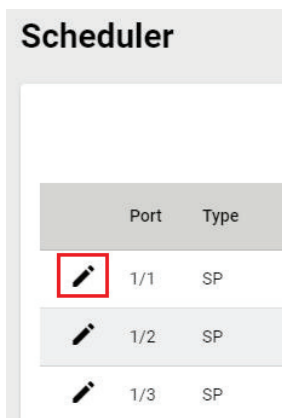

Configure the following settings.

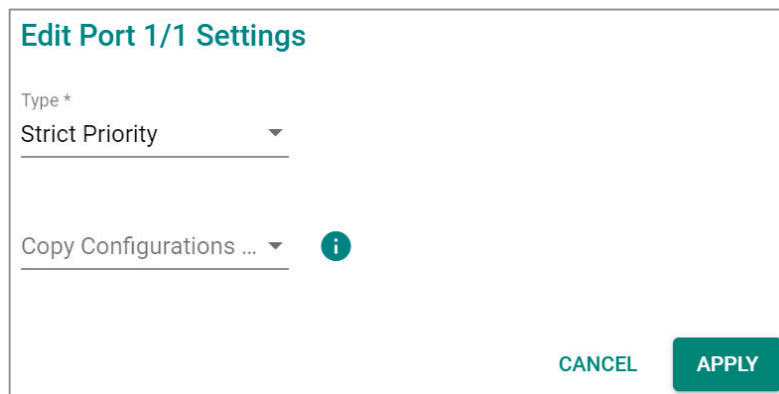

Type

Setting	Description	Factory Default
Strict Priority	Set scheduler algorithm as Strict Priority.	Strict Priority
Weighted Round Robin	Set the scheduler algorithm as Weighted Round Robin: The queued packet will be forwarded by its associated weight.	

Copy Configurations to Ports

Setting	Description	Factory Default
Select the port from the drop-down list	Copy the same settings to other ports.	None

When finished, click **APPLY** to save your changes.





Egress Shaper Overview

A shaper typically delays excess traffic using a buffer or queueing mechanism to hold packets and shape the flow when the data rate of the source is higher than expected. There are two possible metering algorithms: token bucket, or leaky bucket. The leaky bucket algorithm works similarly to the way an actual leaky bucket holds water: The leaky bucket takes data and collects it up to a maximum capacity. Credit in the bucket is only released from the bucket at a set rate. When the bucket consumes all data, the leaking will stop. If incoming data would overflow the bucket, then the packet is considered to be non-conformant and is not added to the bucket. Data will be added back to the bucket as space becomes available for conforming packets.

Egress Shaper Settings and Status

This section describes how to configure Egress Shaper. Switch to **Advanced Mode** first and select **Egress Shaper** in the menu and then click the  icon on the port you want to configure.

Egress Shaper

	Port	Egress Rate (CIR)	CBS
	1/1	1000	1024
	1/2	1000	1024
	1/3	1000	1024
	1/4	1000	1024

Configure the following settings.

Edit Port 1/1 Settings

CIR *

10000

1 - 10000 Mbps

CBS *

1024

10 - 10240 KByte

Copy Configurations ... 

CANCEL APPLY

CIR (Committed Information Rate) (Mbps)

Setting	Description	Factory Default
1 to 1000	The average committed data transmission rate.	1000

CBS (Committed Burst size) (Kbyte)

Setting	Description	Factory Default
10 to 10240	The maximum traffic amount (in Kbyte) that can be transmitted within a very short interval of time or burst.	1024





Copy Configurations to Ports

Setting	Description	Factory Default
Select the port from the drop-down list	Copy the same settings to the other ports.	None

When finished, click **APPLY** to save your changes.

You can view the Egress Shaper status.

Egress Shaper

Port	Egress Rate (CIR)	CBS
 1/1	1000	1024
 1/2	1000	1024
 1/3	1000	1024
 1/4	1000	1024

Multicast

Multicast filtering improves the performance of networks that carry multicast traffic. This section will explain the Layer 2 multicast settings, such as **IGMP Snooping**, **GMRP**, and **Static Multicast**.

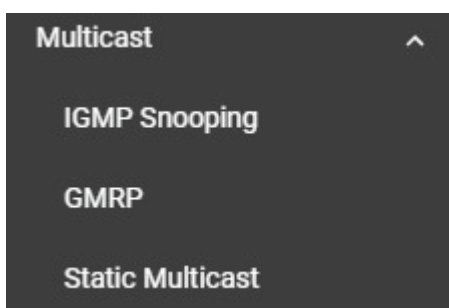

IGMP Snooping

IGMP Snooping Overview

IGMP stands for **Internet Group Management Protocol**, which is a network communication protocol that hosts nearby routers on networks to construct multicast group memberships.

IGMP snooping allows a network switch to listen in on the IGMP conversation between hosts and routers. By listening to these conversations, the switch maintains an association mapping table between port(s) and multicast group.

How IGMP Snooping Works

A switch will, by default, flood multicast traffic to all the other ports, aside ingress, in a broadcast domain (or the VLAN equivalent). Multicast can cause unnecessary loading for host devices by requiring them to process packets they have not solicited. IGMP snooping is designed to prevent hosts on a local network from

receiving traffic for a multicast group they have not explicitly joined. It provides switches with a mechanism to forward multicast traffic to specific ports that receive IGMP hosts. Hence, IGMP snooping can utilize the network bandwidth more efficiently.

Without IGMP Snooping

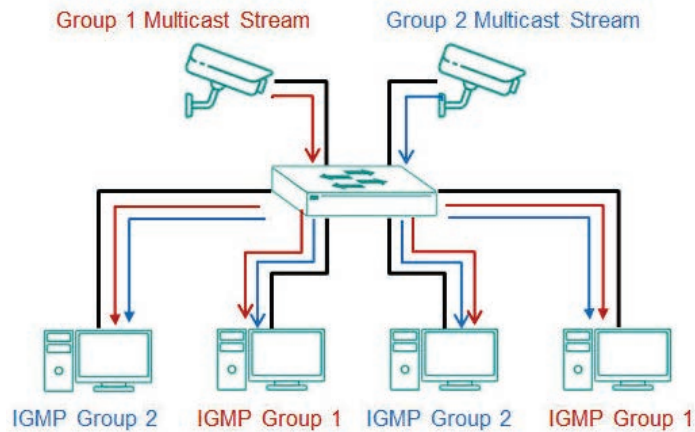

With IGMP Snooping

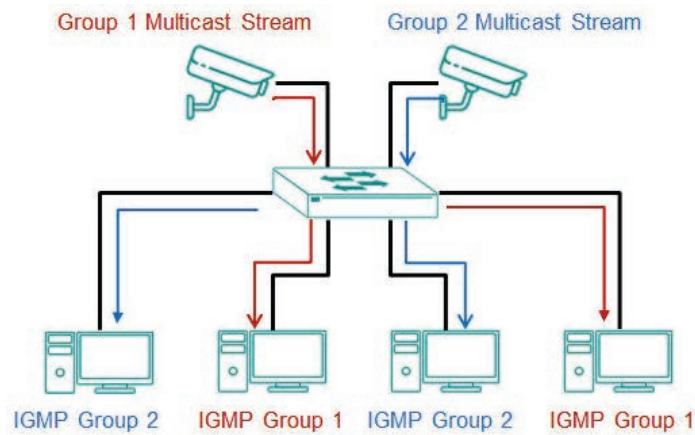

Differences Between IGMP Snooping V1, V2, and V3

IGMP protocols regulate the communication mechanism between querier and listener. IGMP Snooping has three different versions. Refer to the following table for the detailed differences.

IGMP Version	Main Features	Reference
V1	The IGMPv1 querier will periodically send out a "query". Listeners can solicit a "report" of their interested group. However, IGMPv1 does not have a "leave group" message, and the querier might need to implement a timeout mechanism for each registered group.	RFC-1112
V2	Compatible with V1 and the following functions: a. Group-specific query b. Leave group messages c. Resends specific queries to verify leave message was the last one in the group d. Querier election if multiple capable queries are present.	RFC-2236
V3	Compatible with V1, V2, and the following functions: Source filtering enables hosts to specify: - the multicast traffic from a specified source - the multicast traffic from any source except a specified source	RFC-3376

IGMP Snooping Settings

First, select **IGMP Snooping** on the menu and then click the **General** tab on the configuration page.

IGMP Snooping

General
VLAN Settings
Group Table
Forwarding Table

IGMP Snooping *

Disabled ▼

APPLY

IGMP Snooping

Setting	Description	Factory Default
Enabled	Enable IGMP Snooping on a specific VLAN.	Disabled
Disabled	Disable IGMP Snooping on a specific VLAN.	



When finished, click **APPLY** to save your changes.

Configuring VLAN Setting

Click the **VLAN Setting** tab, and then click the  icon to configure the VLAN settings.

IGMP Snooping

General
VLAN Setting
Group Table
Forwarding Table

	VLAN	Enable	Version	Query Interval	Config Role	Active Role	Static Router Port
	1	Disabled	2	125	Querier	Non-Querier	
	2	Disabled	2	125	Querier	Non-Querier	

Edit VLAN 1 Settings

IGMP Snooping *
 Disabled ▼

Version *
 2 ▼

Query Interval *
 125
 20 - 600 sec.

Static Router Port ▼

Config Role *
 Querier ▼

CANCEL APPLY

IGMP Snooping

Setting	Description	Factory Default
Enabled	Enable IGMP Snooping on a switch.	Disabled
Disabled	Disable IGMP Snooping on a switch.	

Version

Setting	Description	Factory Default
1, 2, 3	Specify the IGMP version of the packets that the switch listens to and send queries for.	2

Query Interval (sec)

Setting	Description	Factory Default
20 to 600	Specify the query interval for the Querier function globally (Querier has to be enabled.)	125

Static Router Port

Setting	Description	Factory Default
Check the port from the drop-down list	The router port is the port that connects to the upper level router (or IGMP querier), or to the upper level router of downstream multicast streams. All of the received IGMP signaling packets or multicast streams will be forwarded to those static router ports.	None

Config Role

Setting	Description	Factory Default
Querier	The switch will act as the Querier role.	Querier
Non-Querier	The switch will not act as the Querier role.	

When finished, click **APPLY** to save your changes.

Viewing the Group Table

Click the **Group Table** tab, which allows you to view the current Group Table status.

IGMP Snooping

General | VLAN Setting | **Group Table** | Forwarding Table

Refresh | Add

VLAN	Group Address	Filter Mode	Port	Source Address
1	239.255.255.250	Exclude	3/4	0.0.0.0

Refer to the following table for the detailed description for each item.

Item	Description
VLAN	The VLAN ID.
Group Address	The registered multicast group.
Filter Mode	Only applicable for IGMPv3. (v1 and v2 will display "N/A") Include: source-specific multicast address group Exclude: source-specific exclusive multicast address group
Port	The forwarded port.
Source Address	Only applicable for IGMPv3. (v1 and v2 will display N/A)

Viewing the Forwarding Table

Click the **Forwarding Table** tab to view the current forwarding table.

IGMP Snooping

General | VLAN Setting | Group Table | **Forwarding Table**

Refresh | Add

VLAN	Group Address	Source Address	Port
1	239.255.255.250	192.168.127.1	3/4

Refer to the following table for a description of each item.

Item	Description
VLAN	The VLAN ID.
Group Address	The associated multicast group address of the streaming data.
Source Address	The source address of the streaming data.
Port	The forwarded port.

GMRP

GMRP stands for GARP Multicast Registration Protocol, which is a Generic Attribute Registration Protocol (GARP) application that can be used to prevent multicast from data flooding. Both GMRP and GARP are defined by the IEEE 802.1P, and widely used as a standard protocol in various industrial-related applications. GMRP allows bridges and the devices at the edge of the network to perform a dynamic group membership information registration with the MAC bridges connected to the same LAN section. The information can be transmitted among all bridges in the Bridge LAN that is implemented with extended filtering features. To operate GMRP, the GARP service must be established first.

Configuring GMRP Setting

To configure the GMRP settings, click **GMRP** on the menu.

GMRP

GMRP*
 Disabled ▼

APPLY

Configure the following settings.



GMRP

Setting	Description	Factory Default
Enabled	Enable GMRP.	Disabled
Disabled	Disable GMRP.	

When finished, click **APPLY** to save your changes.

Configuring GMRP Settings for Each Port

Next, click the  icon on the port you want to configure.

	Port	Enable	Group Restrict
	1/1	Disabled	Disabled
	1/3	Disabled	Disabled
	1/4	Disabled	Disabled

Configure the following settings.

Edit Port 1/1 Settings

GMRP*
 Disabled ▼

Group Restrict*
 Disabled ▼

Copy Configurations ... ▼ 

CANCEL **APPLY**

GMRP

Setting	Description	Factory Default
Enabled	Enable GMRP for this port.	Disabled
Disabled	Disable GMRP for this port.	

Group Restrict

Setting	Description	Factory Default
Enabled	Enable Group Restrict on the port. This specific port will not process any GMRP control packets.	Disabled
Disabled	Disable Group Restrict on the port. The specific port will receive and process incoming GMRP control packets.	

Copy Configurations to Ports

Setting	Description	Factory Default
Select the port(s) from the drop-down list	Allows you to copy the configurations to other port(s).	None

When finished, click **APPLY** to save your changes.

Static Multicast

Click **Static Multicast** on the menu to view the current multicast table.

Adding Static Multicast Entry

To add more entries, click the  icon.

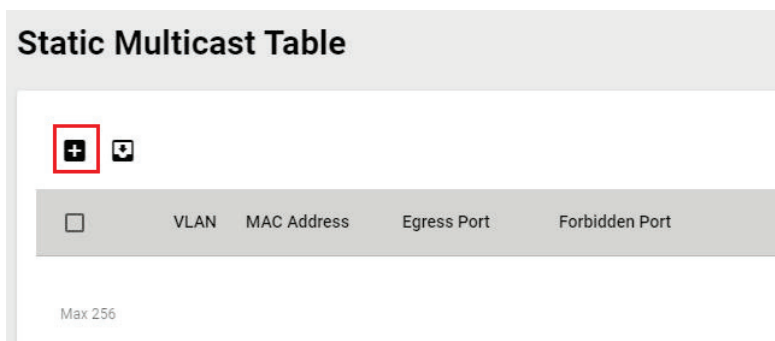

Configure the following settings.

Add Static Multicast Entry

VLAN ID * MAC Address *

Port *

Forbidden Port

VLAN ID

Setting	Description	Factory Default
Input the VID	Specify the multicast group's associated VLAN ID.	None

MAC Address

Setting	Description	Factory Default
Input the MAC address	Specify the multicast MAC address.	None

Port

Setting	Description	Factory Default
Input the port from the drop-down list	Set the port(s) as an egress port(s) so that multicast streams can be forwarded to this port.	None

Forbidden Port

Setting	Description	Factory Default
Input the port from the drop-down list	Set the port as forbidden so that packets cannot be forwarded to this port.	None

When finished, click **CREATE**.

Network Redundancy

Setting up the Redundancy Protocol on your network helps protect critical links against failure, protects against network loops, and keeps network downtime to a minimum.

The Redundancy Protocol allows you to set up redundant paths on the network to provide a backup data transmission route in the event that a cable or one of the switches is inadvertently disconnected or damaged. This is a particularly important feature for industrial applications, since it can take several minutes to address the link down port or failed switch. For example, if a Moxa switch is used as a key communications device for a production line, several minutes of downtime can cause a big loss in production and revenue. Moxa switches support the following Redundancy Protocol functions:

- **Spanning Tree**
- **Turbo Ring V2**
- **Turbo Chain**
- **Dual Homing**
- **MRP**

Layer 2 Redundancy

First select **Network Redundancy** on the menu and then click **Layer 2 Redundancy**.

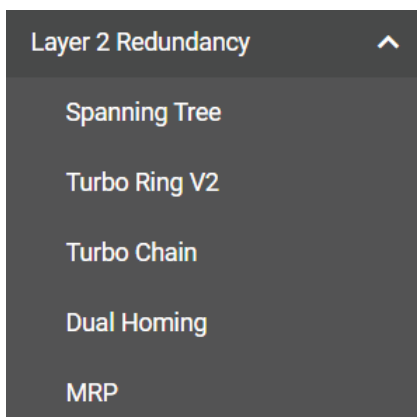

Spanning Tree

Spanning Tree Overview

Spanning Tree Protocol (STP) was designed to help construct a loop-free logical topology on an Ethernet network and provide an automatic means of avoiding any network loops. This is particularly important for networks that have a complicated architecture, since unintended loops in the network can cause broadcast storms. Moxa switches' STP feature is disabled by default. To be completely effective, you must enable STP/RSTP on every Moxa switch connected to your network.

STP (802.1D) is a bridge-based system that is used to implement parallel paths for network traffic. STP uses a loop-detection process to:

- Locate and then disable less efficient paths (e.g., paths that have lower bandwidth).
- Enable one of the less efficient paths if a more efficient path fails.

How STP Works

The figure below shows a network made up of three LANs separated by three bridges. Each segment uses at most two paths to communicate with the other segments. Since this configuration can give rise to loops, the network will overload if STP is not enabled.

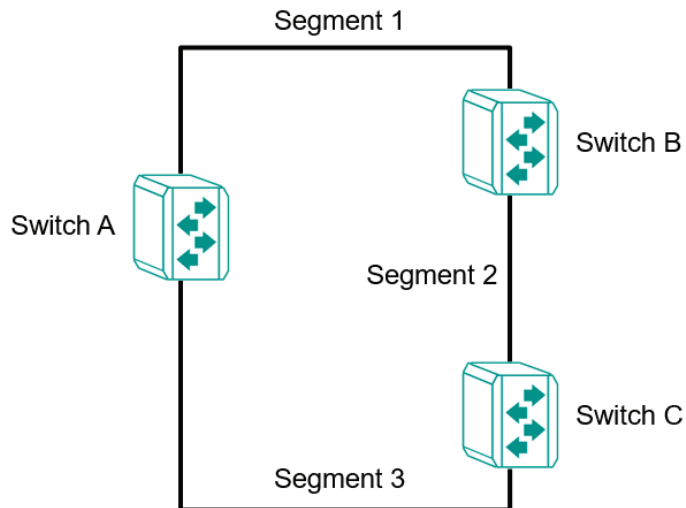

If STP is enabled, it will detect duplicate paths or block one of the paths from forwarding traffic. In the following example, STP determined that traffic from segment 2 to segment 1 flows through switches C and A since this path is in a forwarding state and is processing BPDUs. However, switch B on segment 1 is in a blocking state.

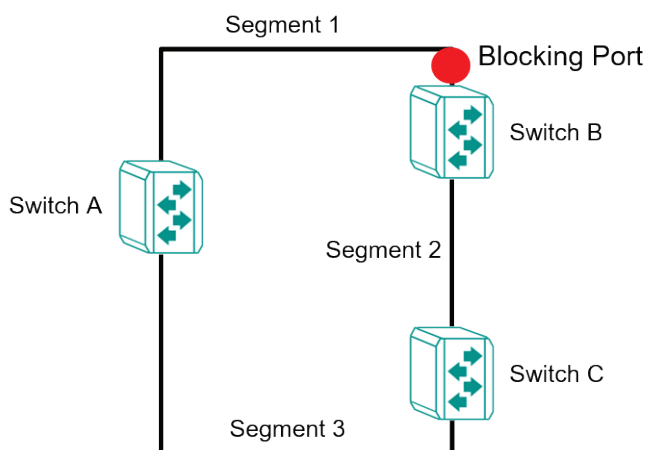

What happens if a link failure is detected? As shown in the figure below, the STP will change the blocking state to a forwarding state so that traffic from segment 2 flows through switch B to segment 1 through a redundant path.

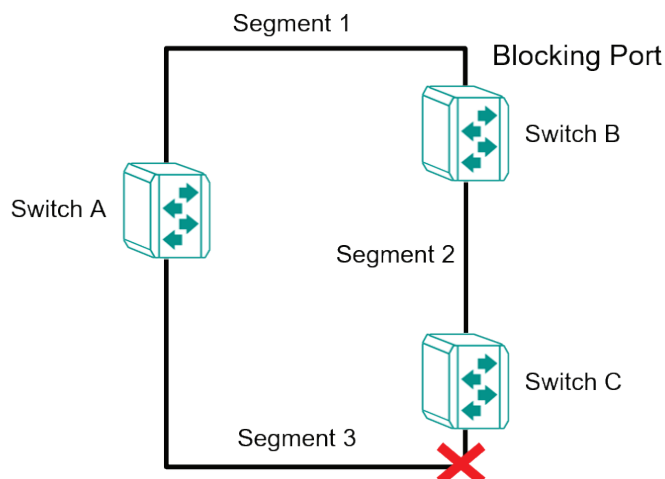

STP will determine which path between each segment is most efficient, and then assign a specific reference point on the network. When the most efficient path has been identified, the other paths are blocked. In the previous three figures, STP first determined that the path through switch C was the most efficient, and as a result, blocked the path through switch B. After the failure of switch C, STP re-evaluated the situation and opened the path through switch B.

Difference Between STP and RSTP

RSTP is similar to STP but includes additional information in the BPDUs that allow each bridge to confirm that it has taken action to prevent loops from forming when it decides to enable a link to a neighboring bridge. Adjacent bridges connected via point-to-point links will be able to enable a link without waiting to ensure that all other bridges in the network have had time to react to the change. The main benefit of RSTP is that the configuration decision is made locally rather than network-wide, allowing RSTP to carry out automatic configuration and restore a link faster than STP.

STP and RSTP spanning tree protocols operate without regard to a network's VLAN configuration and maintain one common spanning tree throughout a bridged network. Thus, these protocols map one loop-free, logical topology on a given physical topology.

STP/RSTP Settings and Status

This section describes how to configure Spanning Tree settings.

General

Click **Spanning Tree** on the menu and then select the **General** tab.

The screenshot shows the 'Spanning Tree' configuration page with the 'General' tab selected. The 'STP Mode' dropdown menu is set to 'Disabled'. Below the dropdown is a green 'APPLY' button.

Configure the following settings.

STP Mode

Setting	Description	Factory Default
Disabled	Disable Spanning Tree.	Disabled
STP/RSTP	Specify STP/RSTP as the STP mode.	
MSTP	Specify MSTP as the STP mode.	

STP/RSTP Mode Settings

If you select **STP/RSTP** as the STP mode, configure the following settings.

The screenshot shows the 'Spanning Tree' configuration page with the 'General' tab selected. The 'STP Mode' is set to 'STP/RSTP', 'Compatibility' is 'RSTP', and 'Bridge Priority' is '32768'. Below these are four input fields: 'Forward Delay Time' (15), 'Hello Time' (2), 'Max. Age' (20), and 'Error Recovery Time' (300). Each field has a range and unit below it. A green 'APPLY' button is at the bottom.

STP Mode

Setting	Description	Factory Default
STP/RSTP	Use the STP/RSTP mode as the Spanning Tree protocol.	STP/RSTP

Compatibility

Setting	Description	Factory Default
STP	To be compatible with STP mode only	RSTP
RSTP	To be compatible with RSTP and STP modes	

Bridge Priority

Setting	Description	Factory Default
0 to 61440	Increase this device's bridge priority by selecting a lower number. A device with a higher bridge priority has a greater chance of being established as the root of the Spanning Tree topology.	32768

Forwarding Delay Time (sec.)

Setting	Description	Factory Default
4 to 30	The amount of time the device waits before checking to see if it should change to a different state.	15

Hello Time (sec.)

Setting	Description	Factory Default
1 or 2	The root of the Spanning Tree topology periodically sends out a "hello" message to other devices on the network to check if the topology is healthy. The "hello time" is the amount of time the root waits between sending hello messages.	2

Max Age (sec.)

Setting	Description	Factory Default
6 to 40	If this device is not the root, and it has not received a hello message from the root in the amount of time equal to "Max. Age," then this device will reconfigure itself as a root. Once two or more devices on the network are recognized as a root, the devices will renegotiate a new Spanning Tree topology.	20

Error Recovery Time (sec.)

Setting	Description	Factory Default
30 to 65535	If the BPDU guard is triggered on a port, it will automatically recover to the normal state after the Error Recovery Time.	300

When finished, click **APPLY** to save your changes.

If you select **MSTP** as the STP mode, configure the following settings.

Spanning Tree

General Guard Status

STP Mode: **MSTP** Compatibility*: **MSTP**

Forward Delay Time *	Hello Time *	Max. Age *	Error Recovery Time *
15	2	20	300
4 - 30 sec.	1 - 2 sec.	6 - 40 sec.	30 - 65535 sec.
Region Name	Region Revision *	Max. Hops *	
MSTP	0	20	
4 / 32	0 - 65535	6 - 40	

APPLY

STP Mode

Setting	Description	Factory Default
MSTP	Use the MSTP mode as the Spanning Tree protocol.	MSTP

Compatibility

Setting	Description	Factory Default
MSTP	To only be compatible with MSTP mode.	MSTP
STP	To only be compatible with STP mode.	
RSTP	To be compatible with RSTP and STP modes.	

Forwarding Delay Time (sec.)

Setting	Description	Factory Default
4 to 30	The amount of time the device waits before checking to see if it should change to a different state.	15

Hello Time (sec.)

Setting	Description	Factory Default
1 or 2	The root of the Spanning Tree topology periodically sends out a "hello" message to other devices on the network to check if the topology is healthy. The "hello time" is the amount of time the root waits between sending hello messages.	2

Max Age (sec.)

Setting	Description	Factory Default
6 to 40	If this device is not the root, and it has not received a hello message from the root in the amount of time equal to "Max. Age," then this device will reconfigure itself as a root. Once two or more devices on the network are recognized as a root, the devices will renegotiate a new Spanning Tree topology.	20

Error Recovery Time (sec.)

Setting	Description	Factory Default
30 to 65535	If the BPDU guard is triggered on a port, it will automatically recover to the normal state after the Error Recovery Time.	300

Region Name

Setting	Description	Factory Default
0 to 32 characters	Provide the region name.	MSTP

Region Revision

Setting	Description	Factory Default
0 to 65535 (characters)	Provide the region revision.	0



Max. Hops

Setting	Description	Factory Default
6 to 40	Provide the maximum hops value.	20

When finished, click **APPLY** to save your changes.

Editing Spanning Tree for a Port

To edit the spanning tree settings for a specific port, click the  icon on the port you want to configure.

	Port	Enable	Edge	Priority	Path Cost	Link Type
	1/1	Disabled	Auto	128	0	Auto
	1/3	Disabled	Auto	128	0	Auto
	1/4	Disabled	Auto	128	0	Auto

Configure the following settings.

Edit Port 1/1 Settings

Enable *
 Disabled ▼

Edge *
 Auto ▼

Priority *
 128

0 - 240, multiples of 16

Path Cost *
 0 i

0 - 200000000

Link Type *
 Auto ▼

Copy Configurations ... i

CANCEL
APPLY

Enable

Setting	Description	Factory Default
Enabled	Enable Spanning Tree.	Disabled
Disabled	Disable Spanning Tree.	

Edge

Setting	Description	Factory Default
Auto	Automatically detect to be the edge port.	Auto
Yes	Set as an edge port.	
No	Do not set as an edge port.	

Priority

Setting	Description	Factory Default
0 to 240 (multiples of 16)	Increase the priority of a port by selecting a lower number. A port with a higher priority has a greater chance of being a root port.	128

Path Cost

Setting	Description	Factory Default
0 to 20000000	The path cost value will be automatically assigned according to the different port speed if the value is set to zero.	0

Link Type

Setting	Description	Factory Default
Point-to-point	Set to Point-to-point when port operating in full-duplex mode, such as a switch.	Auto
Shared	Set to Shared when port operating in half-duplex mode, such as a hub.	
Auto	Automatically select Point-to-point or Shared mode.	

Copy Configurations to Ports

Setting	Description	Factory Default
Select the port(s) from the drop-down list	Copy the configurations to other port(s).	None

Click **APPLY** to finish.

BPDU Overview

BDPUs (Bridge Protocol Data Units) are the network communication frames used in the STP (Spanning Tree Protocol). When two switches exchange messages, BDPUs are used to calculate the STP topology, and determine the network communication route. A BPDU filter is often used to screen sending or receiving BDPUs on a specific port of the switch.

BPDU Guard

BPDU Guard is a protection mechanism that prevents a port from receiving BDPUs. When an RSTP-enabled port receives BDPUs, it will automatically be in the error-disable state, which means the port will in turn switch to Block state. When STP is enabled, all ports are involved in the STP domain, sending and receiving BDPUs. However, when BPDU Guard is enabled, all ports will not receive or send any BDPUs, as all computers and unmanaged switches do not support STP. When BPDU Guard is enabled, all communications will be treated as error-disabled, and the related ports will be blocked, therefore no more data will be sent or received, protecting the network from a loop chain.

Root Guard

Root Guard prevents a designated port role from changing to root port role on reception of superior information.

Loop Guard

Loop Guard prevents temporary loops in a network caused by **non-designated ports** changing to the spanning-tree **forwarding** state due to a link failure in the topology.

BPDU Filter



BPDU Filter prevents a port from sending and processing BDPUs. A BPDU filter enabled port cannot transmit any BDPUs and drop all received BPDU either.

Configuring BPDU Filter, BPDU/Root/Loop Guard Settings

First click **Spanning Tree** on the menu and then select the **Guard** tab. Next, click the  icon on the port you want to configure.

Spanning Tree

General
Guard
Status

	Port	BPDU Guard	rootGuard	Loop Guard	BPDU Filter
	1/1	Disabled	Disabled	Disabled	Disabled
	1/3	Disabled	Disabled	Disabled	Disabled
	1/4	Disabled	Disabled	Disabled	Disabled

Configure the following settings.

Edit Port 1/1 Settings

BPDU Guard *
Disabled ▼

Root Guard *
Disabled ▼

Loop Guard *
Disabled ▼

BPDU Filter *
Disabled ▼

Copy Configurations ... ▼ 

CANCEL
APPLY

BPDU Guard

Setting	Description	Factory Default
Enabled	Enable BPDU Guard.	Disabled
Disabled	Disable BPDU Guard.	



NOTE

To establish a redundant port e.g. it is highly recommended that you do not enable BPDU filter.

Root Guard

Setting	Description	Factory Default
Enabled	Enable Root Guard.	Disabled
Disabled	Disable Root Guard.	

Loop Guard

Setting	Description	Factory Default
Enabled	Enable Loop Guard.	Disabled
Disabled	Disable Loop Guard.	

BDPU Filter

Setting	Description	Factory Default
Enabled	Enable BDPU Filter.	Disabled
Disabled	Disable BDPU Filter.	

Copy Configurations to Port

Setting	Description	Factory Default
Select the port(s) from the drop-down list	Copy the same settings to other port(s).	None

When finished, click **APPLY** to save your changes.

Viewing Current Spanning Tree Status

Click the **Status** tab to view the current Spanning Tree status.

Spanning Tree

General Guard **Status**

Root Information

Bridge ID
32768/00:90:e8:72:56:12

Root Path Cost
0

Forward Delay Time
15 (sec.)

Hello Time
2 (sec.)

Max. Age
20 (sec.)

Bridge Information

Bridge ID
32768/00:90:E8:72:56:12

Running Protocol
RSTP

Forward Delay Time
15 (sec.)

Hello Time
2 (sec.)

Max. Age
20 (sec.)

In addition, the status for each port will also be shown below.

Port	Edge	Port Role	Port State	Root Path Cost	Path Cost	Link Type	BPDU Inconsistency	Root Inconsist
1/1	No	Disabled	Discarding	0	2000	Point-to-Point	No	No
1/3	No	Disabled	Discarding	0	2000	Point-to-Point	No	No
1/4	No	Disabled	Discarding	0	2000	Point-to-Point	No	No
2/1	No	Disabled	Forwarding	0	20000	Point-to-Point	No	No
2/2	No	Disabled	Discarding	0	20000	Point-to-Point	No	No
2/3	No	Disabled	Discarding	0	20000	Point-to-Point	No	No
2/4	No	Disabled	Discarding	0	20000	Point-to-Point	No	No

Refer to the following table for detailed description of each item.

Item	Description
Port	The port number on this device.
Edge	Show if this port is connected to an edge device.
Port Rule	Root: The port is connected directly or indirectly to the root device. Designated: The port is designated if it can send the best BPDU on the segment to which it is connected. Alternate: The alternate port receives more useful BPDU from another bridge and is the blocked port. Backup: The backup port receives more useful BPDU from the same bridge and is the blocked port. Disabled: The function is disabled.
Port State	Forwarding: The traffic can be forwarded through this port. Blocked: The traffic will be blocked. Disabled: The function is disabled.
Root Path Cost	The total path cost to the root bridge.
Path Cost	The path cost on this link.
Link Type	Edge Port: The port is connected to an edge device. Point-to-Point Non Edge Port: The port is connected to another bridge and is full duplex. Shared Non Edge Port: The port is connected to another bridge and is half duplex.
BPDU Inconsistency	BPDU is received on a port enabled by a BPDU guard.
Root Inconsistency	A port is changed to a root port when enabled by a root guard.
Loop Inconsistency	A loop is detected on this port by a loop guard.

Turbo Ring v2

Turbo Ring v2 Overview

Moxa Turbo Ring is a proprietary self-healing technology that enables fast fault recovery of under 20 ms for Fast Ethernet, and 50 ms for Gigabit Ethernet. Turbo Ring supports two topology expansions—ring coupling and dual-ring—to reduce redundant network cabling and network planning costs and to ensure high reliability of your industrial network applications.

The Turbo Ring v2 protocols identify one switch as the **master** of the network, and then automatically block one port beside master on the ring (red line) to avoid network's redundant loops. In the event that one branch of the ring gets disconnected from the rest of the network, the protocol automatically readjusts the ring so that the part of the network that was disconnected can reestablish contact with the rest of the network.

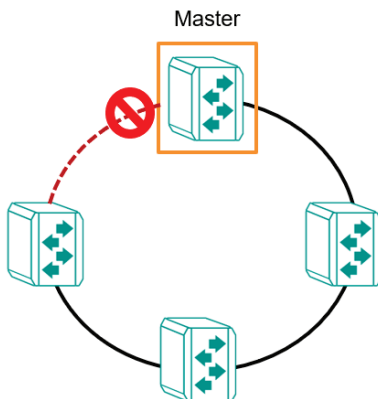

How Turbo Ring v2 Works

Turbo Ring v2 is an advanced technology for network redundancy, which ensures recovery times of less than 20 ms for Fast Ethernet, and 50 ms for Gigabit Ethernet when the network is down. In addition, it allows more switches within the network rings. Users can select different network typologies for Turbo Ring redundancy to allow more network reliability and reduce cabling costs. Below are three examples of how Turbo Ring v2 works.

Ring Coupling

Ring Coupling helps users separate distributed devices into different smaller redundant rings, but in such a way that the smaller rings at different remote sites will be able to communicate with each other. This is useful for applications where some devices are located at remote sites.

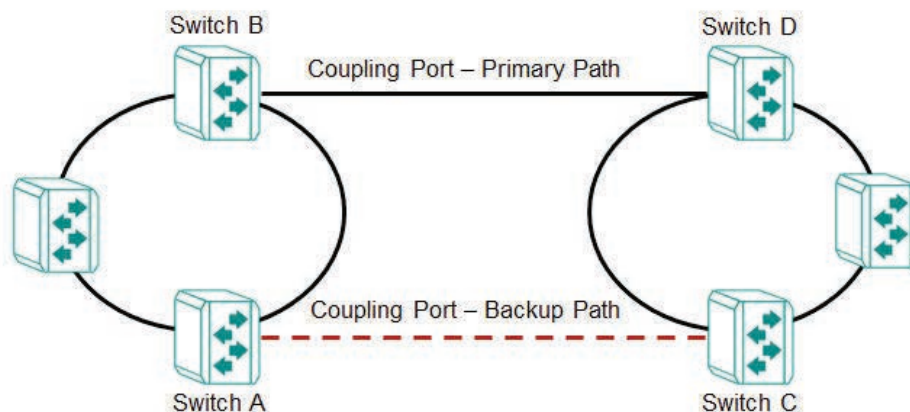

Dual Ring

Dual Ring is a simplified architecture by using a single Moxa switch to connect two separate rings for applications that present cabling difficulties. It provides another ring coupling configuration where two adjacent rings can share one switch. This typology is an ideal solution for applications that have inherent cabling difficulties.

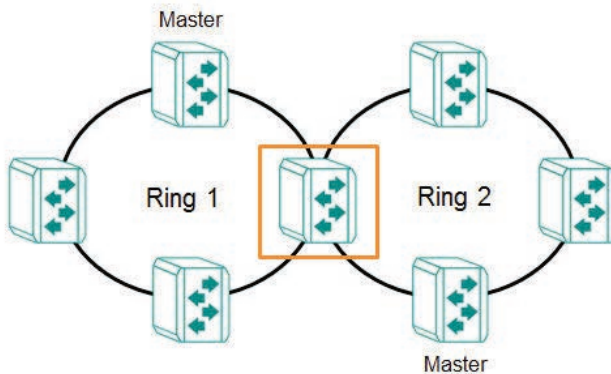

How to Determine the Redundant Path

For Turbo Ring v2, the master is determined by two methods, one is a system MAC address election, the smallest MAC address will play the Master role; the other is user manual configuration to enable Master role on the switch.

The redundant path is determined by "Ring Port 2", which means the port set on "Ring Port 2" will become the blocking port.

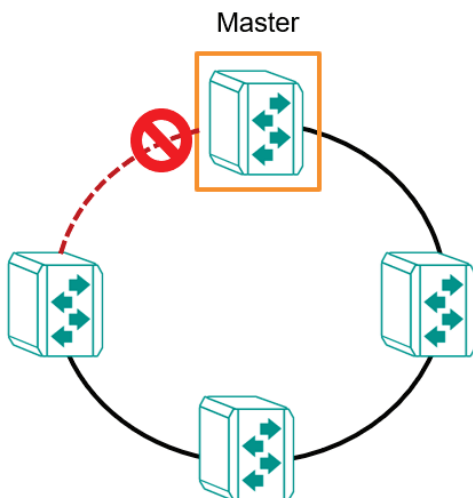

Ring Coupling for a “Turbo Ring V2” Ring

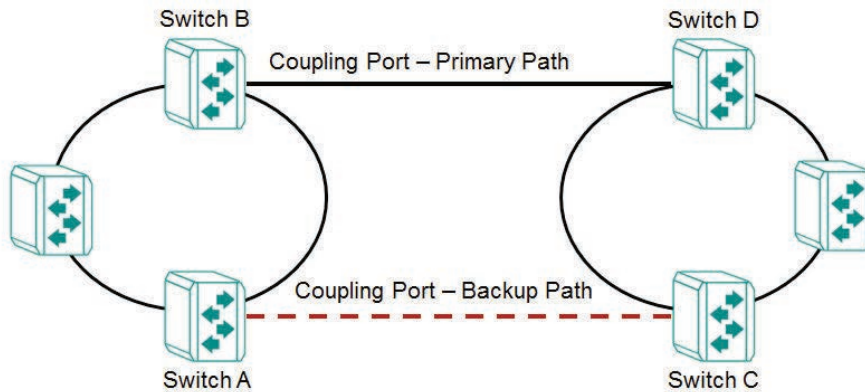

For Turbo Ring V2, Ring Coupling is enabled by configuring the **Coupling Port (Primary)** on Switch B, and the **Coupling Port (Backup)** on Switch A only.

The **Coupling Port (Backup)** on Switch A is used for the backup path, and connects directly to an extra network port on Switch C. The **Coupling Port (Primary)** on Switch B monitors the status of the main path, and connects directly to an extra network port on Switch D. With ring coupling has been established, Switch A can activate the backup path as soon as it detects a problem with the main path.



ATTENTION

Ring Coupling needs to be enabled on one coupling primary switch and one coupling backup switch as the Ring Coupler. The Coupler must designate different ports as the two Turbo Ring ports and the coupling port.



NOTE

You do not need to use the same switch for both Ring Coupling and Ring Master.

Turbo Ring V2 Settings and Status

Click **Turbo Ring V2** on the menu, and then select the **Setting** tab.

Turbo Ring V2

Settings
Status

Turbo Ring V2 *

Disabled ▼

APPLY

Configure the following setting.



Turbo Ring V2

Setting	Description	Factory Default
Enabled	Enable Turbo Ring V2.	Disabled
Disabled	Disable Turbo Ring V2.	

When finished, click **APPLY** to save your changes.

Ring Settings

In **Ring Setting**, click the  icon.

Ring Setting					
	Ring ID	Enabled	Master	Ring Port 1	Ring Port 2
	Ring 1	Disabled	Disabled	2/2	2/3
	Ring 2	Disabled	Disabled	3/4	1/3

Configure the following settings. When finished, click **Apply** to save your changes.

Ring 1 Settings

Enabled *

Disabled

Master *

Disabled

Ring Port 1 *

1/1

Ring Port 2 *

2/2

Enable

Setting	Description	Factory Default
Enabled	Enable Ring Setting.	Disabled
Disabled	Disable Ring Setting.	

Master

Setting	Description	Factory Default
Enabled	Enable this switch as the Master.	Disabled
Disabled	Disable this switch as the Master.	

Ring Port 1

Setting	Description	Factory Default
Select the port from the list	Specify this port as the 1st redundant port.	1/1

Ring Port 2

Setting	Description	Factory Default
Select the port from the list	Specify this port as the 2nd redundant port.	1/2

Ring Coupling Overview

Ring Coupling helps users separate distributed devices into different smaller redundant rings, but in such a way that the smaller rings at different remote sites will be able to communicate with each other. This is useful for the applications where some devices are located at remote sites.

Ring Coupling Settings and Status

In the **Ring Coupling Setting**, click the  icon.

Ring Coupling Setting

	Coupling Mode	Enabled	Coupling Port
	Primary Path	Disabled	2/1

Configure the following settings.

Ring Coupling Settings

Enabled *
Disabled ▼

Coupling Mode *
Coupling Primary Path ▼

Coupling Port *
2/1 ▼

CANCEL
APPLY

Enable

Setting	Description	Factory Default
Enabled	Enable Ring Coupling.	Disabled
Disabled	Disable Ring Coupling.	

Coupling Mode

Setting	Description	Factory Default
Coupling Backup Path	Select Coupling Mode to assign the coupling port as the backup path.	Coupling Primary Path
Coupling Primary Path	Select Coupling Mode to assign the coupling port as the primary path.	

Coupling Port

Setting	Description	Factory Default
Select the port from the list	Select the port as the coupling port.	2/1

When finished, click **APPLY** to save your changes.

Ring and Ring Coupling Setting Status

Click **Status** in the Turbo Ring V2 menu to view the current Ring and the Ring Coupling status.

Turbo Ring V2

Setting **Status**

Ring Status

Ring ID	Master ID	Status	Master	Ring Port 1	Ring Port 2
Ring 1	00:00:00:00:00:00	Disabled	Slave	Disabled	Disabled
Ring 2	00:00:00:00:00:00	Disabled	Slave	Disabled	Disabled

Ring Coupling Status

Coupling Mode	Coupling Port
Disabled	Disabled

Refer to the following table for a detailed description for each item of the Ring status.

Item	Description
Ring ID	The ID number of the Ring.
Master ID	The MAC address of the Ring Master.
Status	Healthy: The Ring and the ports are working properly. Break: One or more Rings have been broken.
Master	The device is Master/Slave on this Ring.
Ring Port 1	The port of the first Ring port.
Ring Port 2	The port of the second Ring port.

Refer to the following table for a detailed description for the status of Coupling Mode and Coupling Port.

Item	Description
Coupling Mode	Primary: The main path of Ring Coupling. Backup: The backup path of Ring Coupling.
Coupling Port	The port of the Ring Coupling.

Turbo Chain

Turbo Chain Overview

Moxa's Turbo Chain is an advanced software technology that gives network administrators the flexibility of constructing any type of redundant network topology. In addition, it offers system recovery time under 20 ms for Fast Ethernet, and 50 ms for Gigabit Ethernet for member port link environments. When using the "chain" concept, you first connect the Ethernet switches in a chain and then simply link the two ends of the chain to an Ethernet network.

Turbo Chain can be used on industrial networks that have a complex topology. If the industrial network uses a multi-ring architecture, Turbo Chain can be used to create flexible and scalable topologies with a fast media-recovery time.

How Turbo Chain Works

Moxa's Turbo Chain outperforms traditional ring topologies by providing great flexibility, unrestricted expansion, and cost-effective configurations when connecting separate redundant rings together—in a simplified manner. With Turbo Chain, you can create any complex redundant network that correspond to your needs, while still ensuring great reliability and availability for your industrial Ethernet network applications.

With Moxa's Turbo Chain, network engineers have the flexibility to construct any type of redundant topology with minimum effort—by simply linking Turbo Chain to the Ethernet Network. Turbo Chain allows for unrestricted network expansion. Network engineers no longer need to go through the hassle of reconfiguring the existing network and can simply use Turbo Chain to scale up their redundant networks.

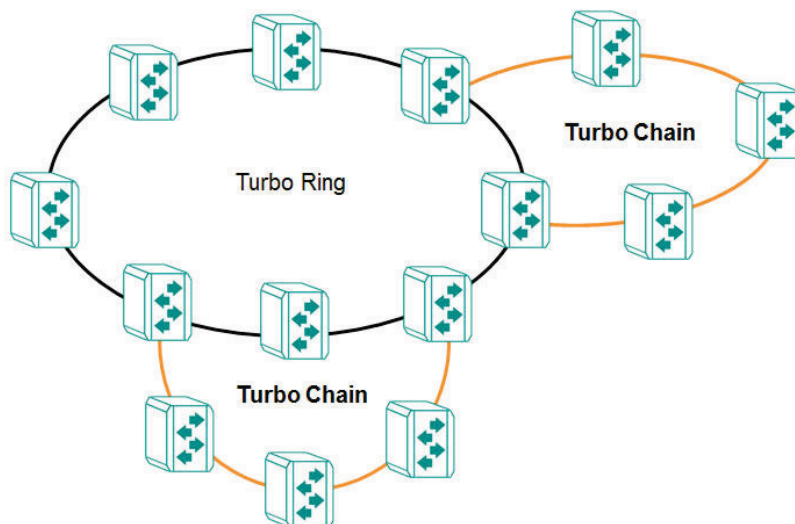

How to Determine the Redundant Path

Here is an example of how to set up Turbo Chain and determine the redundant path.

1. Select the Head switch, Tail switch, and Member switches.
2. Configure one port as the Head port and one port as the Member port in the Head switch, configure one port as the Tail port and one port as the Member port in the Tail switch, and configure two ports as Member ports in each of the Member switches.
3. Connect the Head switch, Tail switch, and Member switches as shown in the diagram below.

The path connecting to the Head port is the main path, and the path connecting to the Tail port is the backup path of Turbo Chain. Under normal conditions, packets are transmitted through the Head Port to the LAN network. If any Turbo Chain path is disconnected, the Tail Port will be activated so that packet transmission can continue.

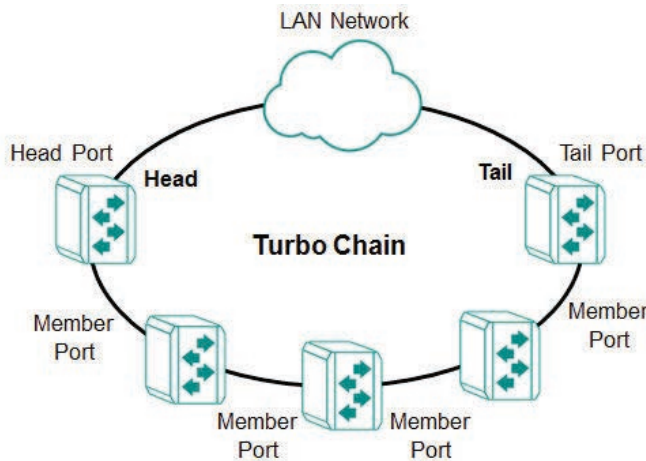

There are two points to note:

1. Two Chain ports must have the same PVID.
2. Chain ports must join the untagged members of PVID VLAN before being assigned to be a Chain port.

Turbo Chain Settings and Status

First select **Turbo Chain** on the menu and then click **Settings**.

Turbo Chain

Settings
Status

Turbo Chain *

Disabled ▼

Chain Role *

Member ▼

Member Port 1 *

1/1 ▼

Member Port 2 *

2/3 ▼

APPLY

Configure the following settings.

Turbo Chain

Setting	Description	Factory Default
Enabled	Enable Turbo Chain.	Disabled
Disabled	Disable Turbo Chain.	

Chain Role

Setting	Description	Factory Default
Head	Enable chain role as the Head.	Member
Member	Enable chain role as a Member.	
Tail	Enable chain role as the Tail.	

Member Port 1

Setting	Description	Factory Default
Select the port from the list	Specify the port as the Head/Member/Tail port.	1/1

Member Port 2

Setting	Description	Factory Default
Select the port from the list	Specify the port as the member port.	1/2

When finished, click **APPLY** to save your changes.

Select **Turbo Chain** on the menu and click **Status** to view the current Turbo Chain status.

Item	Description
Turbo Chain	Disabled
Chain Role	Member
Member 1 Port Status	Disabled
Member 2 Port Status	Disabled

Refer to the following table for a detailed description of each item.

Item	Description
Turbo Chain	Enabled: Turbo Chain is enabled. Disabled: Turbo Chain is disabled.
Chain Role	Head: The device is the head of this chain. Member: The device is a member of this chain. Tail: The device is the tail of this chain.
Member 1 Port Status	The status of the first Head/Member/Tail port.
Member 2 Port Status	The status of the second Head/Member/Tail port.



NOTE

Auto-negotiation and Far-end-fault are not supported on certain ports of the EDS-4014-4GS-2QGS and EDS-G4014-6QGS and therefore cannot be used for Turbo Chain. Make sure to use supported ports to set up Turbo Chain.

For an optimal Turbo Chain configuration, we recommend using ports G1 to G4 (100/1000BaseSFP) on the EDS-4014-4GS-2QGS and ports QG3 to QG6 (100/1000/2500BaseSFP) on the EDS-G4014-6QGS.

Dual Homing

Dual Homing Overview

Dual Homing is a layer 2 function, which uses a single Ethernet switch to connect two network topologies, both of which can run any redundancy protocols. It involves coupling two separate devices or even coupling to two separate rings with a single switch connecting to two independent connection points. The secondary path will be activated if the primary path fails.

How Dual Homing Works

Dual Homing is a redundant path technology that allows a single switch to connect to any topology.

The primary and secondary paths require manual configuration: Select a primary port as the primary path and the secondary port as the secondary path. The default path switching mode is "primary path always first", which means when failover occurs, the primary path will switch to the secondary path, but if the primary path recovers, the path will switch back to the primary path again even if the secondary path is healthy.

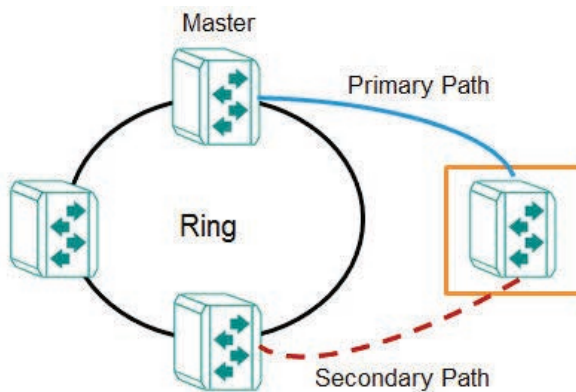

Path Switching Mode

There are two path switch modes that users can configure:

Primary path always first: Always selects the path switching mode as the primary path first. When path switching occurs, the primary path will always be the first path for data communication.

Maintain current path: Select the path switching mode to maintain the current path. When path switching occurs, maintain the current path to keep the network stable and do not change paths for data communication.

Dual Homing Settings and Status

Click **Dual Homing** in the menu and select **Settings**.

Dual Homing

Settings Status

Dual Homing *
Disabled

Primary Port *
1/1

Secondary Port *
2/4 i

Path Switching Mode *
Primary path always first

APPLY

Configure the following settings.

Dual Homing

Setting	Description	Factory Default
Enabled	Enable Dual Homing.	Disabled
Disabled	Disable Dual Homing.	

Primary Port

Setting	Description	Factory Default
Select the port from the list	Specify the port as the primary port.	1/1

Secondary Port

Setting	Description	Factory Default
Select the port from the list	Specify the port as the secondary port.	1/1

Path Switching Mode

Setting	Description	Factory Default
Primary path always first	Always selects path switching mode as the primary path first.	Primary path always first
Maintain current path	Always selects the path switching mode to maintain the current path.	

When finished, click **APPLY** to save your changes.

First, click **Dual Homing** in the menu and then select **Status** to view the current Dual Homing Settings.

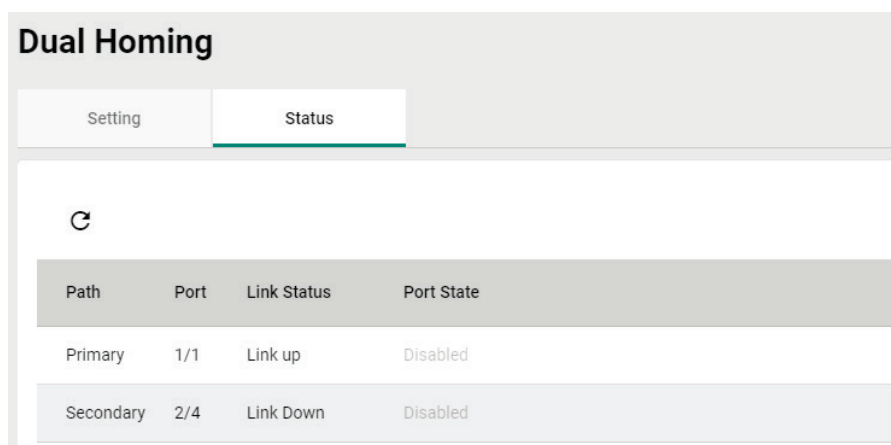

Refer to the following table for a detailed description of each item.

Item	Description
Path	Primary: The primary path of dual homing. Secondary: The secondary path of dual homing.
Port	The port that is used as the primary/secondary path.
Link Status	Link Up: The port is connected. Link Down: The port is disconnected.
Port State	Forwarding: The port is forwarding traffic. Blocking: The port is blocking traffic.

MRP

Overview

MRP (Media Redundancy Protocol) is a network protocol based on the IEC 62439-2 standards that allows users to create a redundant ring system. With a recovery time of less than 200 ms, it can support up to 50 devices in each ring.

MRP includes two roles:

MRM (Media Redundancy Manager)

MRM, also known as the Ring Manager, is a node in the network topology that manages and monitors the health of the entire ring. There is only one MRM in the network. In the event of a Link Down scenario, the MRM diagnoses the issue and notifies all MRCs (Media Redundancy Clients) to flush their MAC address table and relearn the path. Additionally, the MRM changes the port status of the primary port from blocking to forwarding to restore connectivity.

MRC (Media Redundancy Client)

MRC, also known as the Ring Client, is a node in the network topology that is monitored by the MRM (Media Redundancy Manager). However, the MRCs do not solely rely on the MRM to detect the health of the ring, they also automatically notify the MRM in the event of a Link Down or Recovery situation. The MRC flushes its MAC address table and relearns the path when requested by the MRM.

How MRP Works

When implementing MRP, two ports are required and should be designated as the 1st and 2nd redundant ports, respectively.

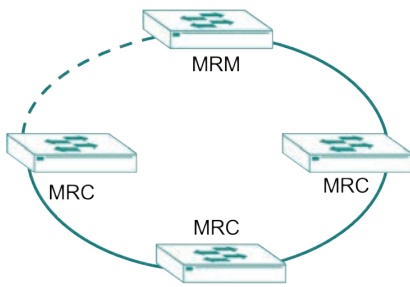

One ring port of the MRM shall be connected to a ring port of an MRC. The other ring port of that MRC shall be connected to a ring port of another MRC or to the second ring port of the MRM.

One of the redundant ports on MRM would be in the blocking state, while the other would be in the forwarding state. The path connected to the blocking port is the redundant path. Similarly, the MRC requires two ports, and both would be forwarding. It's important to note that in the event of a topology change, the backup path may not automatically change back to the original path even if the Link Down issue has been resolved.

MRP Settings

Click **Network Redundancy > Layer 2 Redundancy > MRP**

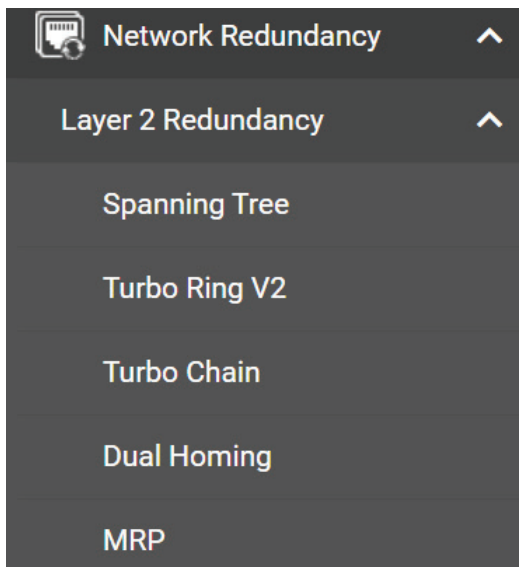

Click the **Settings** tab to configure.

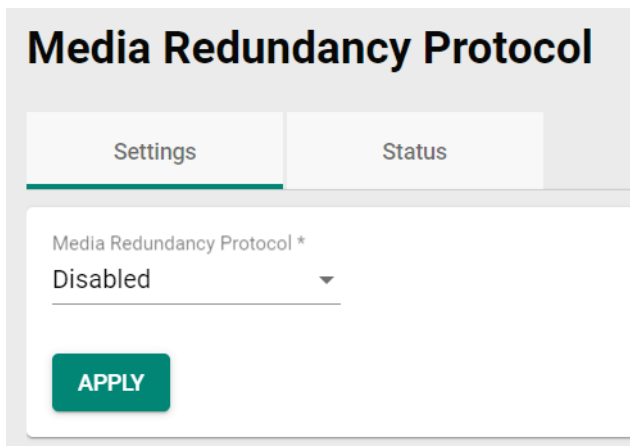

Configure the following setting.

Media Redundancy Protocol

Setting	Description	Factory Default
Enabled	Enable the Media Redundancy Protocol (MRP) and users can configure the following settings.	Disabled
Disabled	Disable the Media Redundancy Protocol.	

When finished, click **APPLY** to save your changes.

If you choose to enable MRP, configure the following settings.

Media Redundancy Protocol

Setting	Description	Factory Default
Enabled	Enable the Media Redundancy Protocol.	Disabled
Disabled	Disable the Media Redundancy Protocol.	

Role

Setting	Description	Factory Default
Ring Client	Specify the Ring Client as the role.	Ring Client
Ring Manager	Specify the Ring Manager as the role, so that the device can manage and monitor the Ring health status.	

VLAN ID

Setting	Description	Factory Default
1 to 4094	Specify the VLAN ID for the Media Redundancy Protocol, and the VLAN ID should align with the ring port settings.	1

Domain UUID

Setting	Description	Factory Default
Domain UUID	Specify the domain UUID.	FFFFFFFF-FFFF-FFFF-FFFFFFFFFFFFFF

React on Link Change (for Ring Manage Role only)

Setting	Description	Factory Default
Enabled	Enable reaction on link change for faster recovery speeds.	Enabled
Disabled	Disable reaction on link change.	

1st Redundant Port

Setting	Description	Factory Default
---------	-------------	-----------------

Select from the list	Specify the port as the 1st redundant port.	None
----------------------	---	------

2nd Redundant Port

Setting	Description	Factory Default
Select from the list	Specify the port as the 2nd redundant port.	None

When finished, click **Apply** to save your changes. You may select the **Status** tab to view the current status of the Media Redundancy Protocol settings.

Media Redundancy Protocol

Settings

Status

Ring Status

MRP Ring
Enabled

Role
Ring Manager

Ring State
Primary Ring Port Link Up

React on Link Change
Enabled

VLAN ID
1

Domain ID
FFFFFFFF-FFFF-FFFF-FFFF-FFFFFFFFFFFF

Interface	Port	Port Status
1st redundant port	1/1	Forwarding
2nd redundant port	1/2	Link Down



NOTE

1. All devices in the ring topology should have MRP enabled to ensure proper operations.
1. Ensure that every redundant port on every device in the MRP topology is in the same VLAN. (For more information, users can refer to the chapter on VLANs.)
2. Before completing the MRP settings on each node, please do not connect all paths to prevent any Looping events.

Configure Ring Manager

Follow the steps below:

1. Click **Enabled** to enable MRP.
2. Select Role as **Ring Manager**.
3. Enter the VLAN ID (only enter an existing VLAN ID).
4. Select Domain UUID.
5. Select Enabled to enable **React on Link Change** for faster recovery speeds.
6. Select the port to be 1st redundant port and 2nd redundant port.

Configure Ring Client

Follow the steps below:

1. Click **Enabled** to enable MRP.
2. Select Role as **Ring Client**.
3. Enter the VLAN ID (only enter an existing VLAN ID that aligns with the Ring Manager).
4. Select Domain UUID.
5. Select 1st redundant port and 2nd redundant port.
6. Click **Apply** to save the configuration.

Click Status tab to check MRP redundant port status.

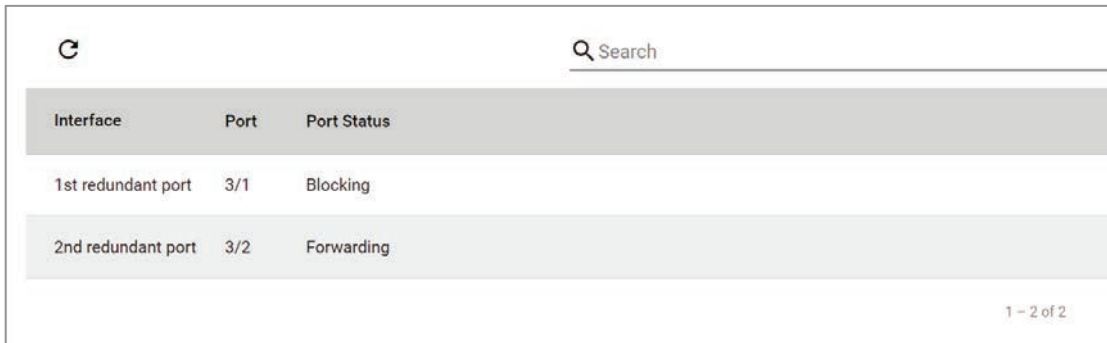

Interface	Port	Port Status
1st redundant port	3/1	Blocking
2nd redundant port	3/2	Forwarding

1 - 2 of 2

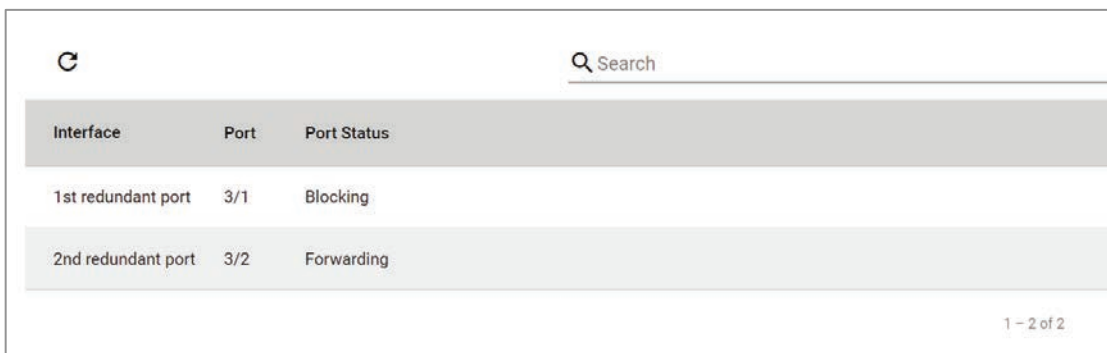

Interface	Port	Port Status
1st redundant port	3/1	Blocking
2nd redundant port	3/2	Forwarding

1 - 2 of 2

Management

This section describes how to configure **Network Management** including **SNMP**.

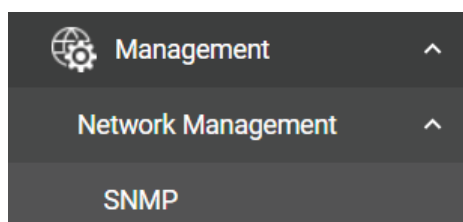

Network Management

This section demonstrates how to configure SNMP settings. For SNMP Trap/Inform settings, refer to **SNMP Trap/Inform** section under **Diagnostics → Log & Event Notifications**.

SNMP

Moxa switches support SNMP V1, V2c, and V3. SNMP V1 and SNMP V2c use a community string match for authentication, which means that SNMP servers access all objects with read-only or read/write permissions using the community strings public and private by default. SNMP V3 requires that you select an authentication level of MD5 or SHA. You can also enable data encryption to enhance data security.

Supported SNMP security modes and levels are shown in the table below. Select the security mode and level that will be used to communicate between the SNMP agent and manager.

Protocol Version	UI Setting	Authentication	Encryption	Method
SNMP V1, V2c	V1, V2c Read Community	Community string	No	Uses a community string match for authentication.
	V1, V2c Write/Read Community	Community string	No	Uses a community string match for authentication.
SNMP V3	None	No	No	Uses an account with admin or user to access objects.
	MD5 or SHA	Authentication based on MD5 or SHA	Disabled	Uses authentication based on HMAC-MD5, or HMAC-SHA algorithms. 8-character passwords are the minimum requirement for authentication.
	MD5 or SHA	Authentication based on MD5 or SHA	Data encryption key: DES, AES	Uses authentication based on HMAC-MD5 or HMAC-SHA algorithms, and data encryption key. 8-character passwords and a data encryption key are the minimum requirements for authentication and encryption.



NOTE

SNMPv3 enhances security as it includes authentication and data privacy. If users require a higher level of security, it is recommended to install additional security mechanisms such as a firewall to protect a critical infrastructure.

General Settings

First click **SNMP** on the menu and then click **General**.

SNMP

General SNMP Account

SNMP Version *
V1, V2c

Read Community *
public
At least 4 characters 6 / 32

Read/Write Community *
private
At least 4 characters 7 / 32

APPLY

Configure the following settings.

SNMP Version

Setting	Description	Factory Default
V1, V2c, V3	Specify V1, V2c, and V3 as the SNMP version.	V1, V2c
V1, V2c	Specify V1 and V2c as the SNMP version.	
V3 only	Specify V3 as the SNMP version.	

Read Community

Setting	Description	Factory Default
4 to 32 characters	Specifies the community string to authenticate the SNMP agent for read-only access. The SNMP agent will access all objects with read-only permissions using this community string.	public

Read/Write Community

Setting	Description	Factory Default
4 to 32 characters	Specifies the community string to authenticate the SNMP agent for read/write access. The SNMP agent will access all objects with read/write permissions using this community string.	private



NOTE

The **Read Community** and **Read/Write Community** strings support the following characters: a-z, A-Z, 0-9, and the following special characters: . _ -

When finished, click **APPLY** to save your changes.

Creating an SNMP Account

Click **SNMP** on the menu and then click the **SNMP Account**. Next click  icon on the page.

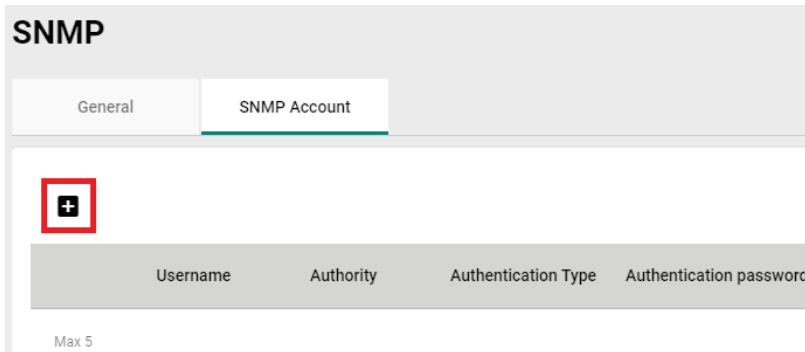

The image shows the 'SNMP' configuration page with the 'SNMP Account' tab selected. Below the tab is a table with four columns: 'Username', 'Authority', 'Authentication Type', and 'Authentication password'. A red square highlights a plus sign icon in the top-left corner of the table area. Below the table, it says 'Max 5'.

Configure the following settings.

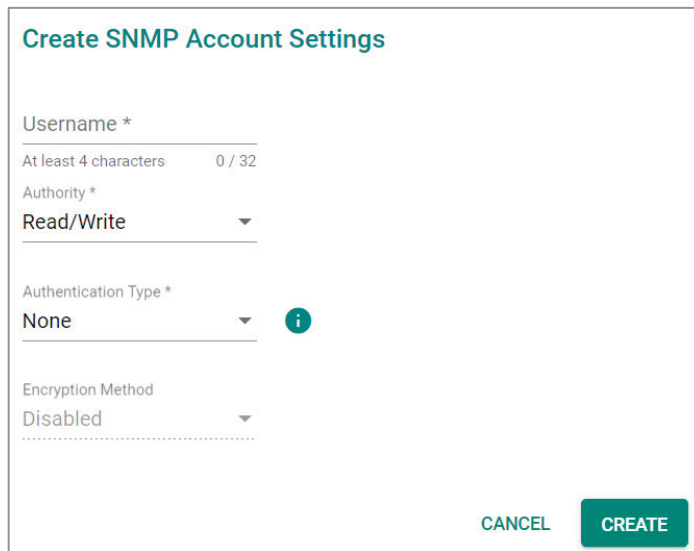

The image shows a 'Create SNMP Account Settings' dialog box. It contains the following fields:

- Username ***: A text input field with a note 'At least 4 characters' and a character count '0 / 32'.
- Authority ***: A dropdown menu currently set to 'Read/Write'.
- Authentication Type ***: A dropdown menu currently set to 'None', with an information icon (i) to its right.
- Encryption Method**: A dropdown menu currently set to 'Disabled'.

 At the bottom right of the dialog are two buttons: 'CANCEL' and 'CREATE'.

Username

Setting	Description	Factory Default
At least 4 characters, (max. 32 characters)	Input a username.	None



NOTE

The **Username** can include the following characters: a-z, A-Z, 0-9, and the following special characters: . _ -

Authority

Setting	Description	Factory Default
Read Write	The user has read/write access.	None
Read Only	The user only has read access.	

Authentication type

Setting	Description	Factory Default
None	No authentication will be used.	None
MD5	MD5 is the authentication type.	
SHA	SHA is the authentication type.	

Authentication password

Setting	Description	Factory Default
---------	-------------	-----------------

8 to 64 characters	Input the authentication password.	None
--------------------	------------------------------------	------



NOTE

The **Authentication Password** can include the following characters: a-z, A-Z, 0-9, spaces, and the following special characters: . , - _ + = | : ; @ ! ~ # % ^ * () [] { }

Encryption Method

Setting	Description	Factory Default
Disabled	Disable the encryption method.	None
DES	DES is the encryption method.	
AES	AES is the encryption method.	

Encryption Key

Setting	Description	Factory Default
8 to 64 characters	Input the encryption key.	None





NOTE

The **Encryption Key** can include the following characters: a-z, A-Z, 0-9, spaces, and the following special characters: . , - _ + = | : ; @ ! ~ # % ^ * () [] { }

When finished, click **CREATE**.

Deleting an Existing SNMP Account

To delete an existing SNMP account, select the  icon on the account.

			
	Username	Authority	Authentication Type
 	test	Read Write	None
Max 5			

Click **DELETE** to delete the SNMP account.

Delete Account

Are you sure you want to delete the selected account?

CANCEL
DELETE

Security

This section describes how to configure **Device Security**, **Network Security**, and **Authentication**.



Device Security

This section includes information about the **Management Interface**, **Login Policy**, **Trusted Access**, and **SSH & SSL** configurations.

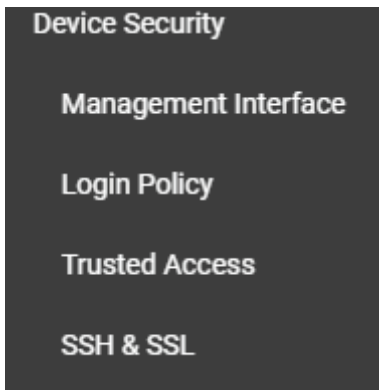

Management Interface

This section describes the settings for **User Interface** and **Hardware Interface**.

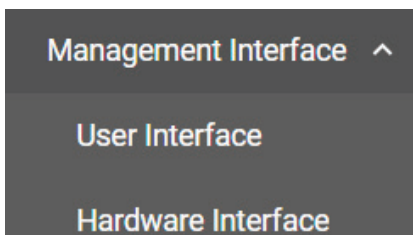

User Interface

Click **User Interface** on the menu.

User Interface

HTTP *	HTTP - TCP Port *	
Enabled	80	
	1 - 65535	
HTTPS *	HTTPS - TCP Port *	
Enabled	443	
	1 - 65535	
Telnet *	Telnet - TCP Port *	
Disabled	23	
	1 - 65535	
SSH *	SSH - TCP Port *	
Enabled	22	
	1 - 65535	
SNMP *	SNMP - UDP Port *	
Disabled	161	
	1 - 65535	
Moxa Service *	Moxa Service(Encrypted) - TCP Port	Moxa Service(Encrypted) - UDP Port
Enabled	443	40404
	1 - 65535	1 - 65535
Maximum number of Login Sessions For HTTP+HTTPS *		
5		
1 - 10		
Maximum number of Login Sessions For HTTP+HTTPS *		
5		
1 - 10		
Maximum number of Login Sessions For Telnet+SSH *		
1		
1 - 5		

APPLY

Configure the following settings.

HTTP

Setting	Description	Factory Default
Enabled	Enable the HTTP connection.	Enabled
Disabled	Disable the HTTP connection.	



NOTE

An HTTP session will be redirected to HTTPS if both HTTP and HTTPS are enabled.

HTTP – TCP Port

Setting	Description	Factory Default
0 to 47808	Specify the HTTP connection port number.	80

HTTPS

Setting	Description	Factory Default
Enabled	Enable the HTTPS connection.	Enabled
Disabled	Disable the HTTPS connection.	

HTTPS – TCP Port

Setting	Description	Factory Default
1 to 65535	Specify the HTTPS connection port number.	443

Telnet

Setting	Description	Factory Default
Enabled	Enable a Telnet connection.	Enabled
Disabled	Disable a Telnet connection.	

Telnet – TCP Port

Setting	Description	Factory Default
1 to 65535	Specify the Telnet connection port number.	23

SSH

Setting	Description	Factory Default
Enabled	Enable the SSH connection.	Enabled
Disabled	Disable the SSH connection.	

SSH – TCP Port

Setting	Description	Factory Default
1 to 65535	Input the SSH connection port number.	22

SNMP

Setting	Description	Factory Default
Enabled	Enable the SNMP connection.	Disabled
Disabled	Disable the SNMP connection.	

SNMP – UDP Port

Setting	Description	Factory Default
0 to 47808	Input the SNMP UDP connection port number.	161



NOTE

Moxa Service is only for Moxa network management software suite.

Moxa Service (Encrypted) – TCP Port

Setting	Description	Factory Default
443 (read only)	Enable a Moxa Service TCP port.	443

Moxa Service (Encrypted) – UDP Port

Setting	Description	Factory Default
40404 (read only)	Enable a Moxa Service UDP port.	40404

Maximum number of Login Sessions for HTTP+HTTPS

Setting	Description	Factory Default
1 to 10	Specify the maximum number of concurrent HTTP and HTTPS login sessions.	5

Maximum number of Login Sessions for Telnet+SSH

Setting	Description	Factory Default
1 to 5	Specify the maximum number of concurrent Telnet and SSH login sessions.	1

When finished, click **APPLY** to save your changes.

Hardware Interface

Click **Hardware Interface** on the menu. This enables you to use Moxa's ABC-02 configuration tool.

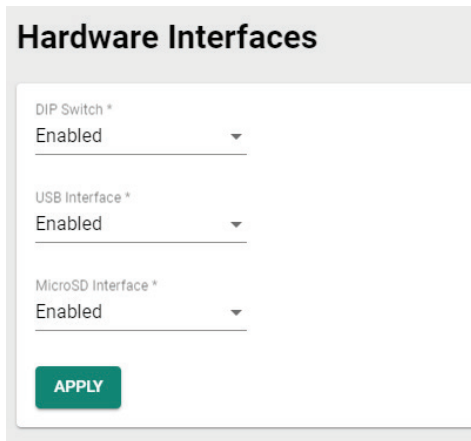

Hardware Interfaces

DIP Switch *
Enabled

USB Interface *
Enabled

MicroSD Interface *
Enabled

APPLY

Configure the following settings.

DIP Switch (for EDS-(G)4000 Series only)

Setting	Description	Factory Default
Enabled	Enable the DIP switch function on the switch.	Enabled
Disabled	Disable the DIP switch function on the switch.	

USB Interface

Setting	Description	Factory Default
Enabled	Enable the USB interface on the switch.	Enabled
Disabled	Disable the USB interface on the switch.	

MicroSD Interface

Setting	Description	Factory Default
Enabled	Enable the microSD interface on the switch.	Enabled
Disabled	Disable the microSD interface on the switch.	

Login Policy

Click **Login Policy** on the menu.

Login Policy

Login Message

0 / 500

Login Authentication Failure Message

0 / 500

Account Login Failure Lockout *

Disabled

Retry Failure Threshold *

5

1 - 10 times

Lockout Time *

5

1 - 10 min.

Auto Logout Setting *

0

0 - 1440 min.

APPLY

Configure the following settings.

Login Message

Setting	Description	Factory Default
0 to 500 characters	Input the message that will be displayed to users when they log in.	None

Login Authentication Failure Message

Setting	Description	Factory Default
0 to 500 characters	Input the message that will be displayed when users fail to log in.	None



NOTE

The **Login Authentication Failure Message** field can only include the following characters, a-z/A-Z/0-9 and special characters ! # \$ % & ' () * + , \ - . / : ; < = > @ [] ^ _ ` { | } ~ and space.

Account Login Failure Lockout

Setting	Description	Factory Default
Enabled	Enable the lockout function when a user fails to log in.	Disabled
Disabled	Disable the lockout function when a user fails to log in.	

Retry Failure Threshold (times)

Setting	Description	Factory Default
1 to 10	Input the maximum number of retry failure times.	5

Lockout Time (min.)

Setting	Description	Factory Default
---------	-------------	-----------------

1 to 10	Specify the lockout duration (in minutes) during which a locked-out user will be unable to log in.	5
---------	--	---

Auto Logout Setting (min.)

Setting	Description	Factory Default
0 to 1440	Specify how long a user has to be inactive before getting logged out.	5

When finished, click **APPLY** to save your changes.

Trusted Access

Trusted Access Overview

Trusted Access is a mechanism that provides a secure connection to Moxa's switch. Users can use this method to allow the connection from the assigned IP address to ensure safe data transmission.

Trusted Access Settings and Status

Click **Trusted Access** on the menu.

Configure the following settings.

Enable

Setting	Description	Factory Default
Enabled	Enable Trusted Access.	Disabled
Disabled	Disable Trusted Access.	



NOTE

1. Trusted Access has to be added before it can be enabled.
2. In order to avoid being disconnected after you enable Trusted Access, you must first add the current IP subnet to Trusted Access. In order to use this function, you should use an RS-232 console to log in or set the device to factory default.

When finished, click **APPLY** to save your changes.

Next, click the  icon.

Trusted Access

Trusted Access *
 Disabled ▾

APPLY



<input type="checkbox"/>	IP Address	Netmask

Max. 20

Create Entry

IP Address *

Netmask *

CANCEL **CREATE**

Configure the following settings.

IP Address

Setting	Description	Factory Default
Input IP address	Specify the IP address that is allowed to connect to Moxa's switch.	None

Netmask

Setting	Description	Factory Default
Input Netmask	Specify the Netmask that is allowed to connect to Moxa's switch.	None

When finished, click **CREATE**.

You can view the Trusted Access status on the figure below.

<input type="checkbox"/>	IP Address	Netmask
<input type="checkbox"/> 	192.168.127.155	255.255.255.0

To delete the trusted access source, select the item and then click  icon on the top of the page.



<input checked="" type="checkbox"/>	IP Address	Netmask
<input checked="" type="checkbox"/>	192.168.127.155	255.255.255.0

Click **DELETE** to delete the item.

Delete Entry

Are you sure you want to delete the selected entry?

[CANCEL](#) [DELETE](#)

SSH & SSL

SSH Key Regeneration

Click **SSH & SSL** on the menu and then select the **SSH** tab.

SSH & SSL

SSH SSL

Regenerate SSH Key

[REGENERATE](#)

Click **Regenerate** to regenerate the key.

SSL Certification Regeneration

Click **SSH & SSL** on the menu and select the **SSL** tab. The Certificate Information is shown on this screen.

The screenshot shows the 'SSH & SSL' configuration page. At the top, there are two tabs: 'SSH' and 'SSL', with 'SSL' selected. Below the tabs is a 'Certificate Information' section displaying the CA Name as 'Moxa Networking Co., Ltd.' and the Expiration Date as '2035-10-18 09:41:44'. Underneath, there are three main sections: 'Export SSL Certificate' with an 'EXPORT' button, 'Regenerate SSL Certificate' with a 'REGENERATE' button, and 'Import Certificate' with a file selection icon and an 'IMPORT' button.

To import a third-party certificate, follow the steps below:

1. Import the root CA generated by third-party CA server to a PC.
2. Click **EXPORT** to download the Certificate Signing Request (CSR) file from the switch. Use this CSR file with your CA server to generate a new SSL certificate.
3. Navigate to the certificate file and click **IMPORT** to import the certificate.

Export SSL Certificate

Setting	Description	Factory Default
Export	Export the SSL Certificate Signing Request (*.csr) to your local computer.	None

Regenerate SSL Certificate

Setting	Description	Factory Default
Regenerate	Regenerate the SSL certificate.	None

Import Certificate

Setting	Description	Factory Default
Select the file	Import the SSL certificate (*.cert) from the location where the SSL certificate is located.	None

Network Security

This section demonstrates how to configure network security settings, including **IEEE 802.1X**, **MAC Authentication Bypass**, **Port Security**, **Traffic Storm Control**, **Access Control List**, **Network Loop Protection**, **Binding Database**, **DHCP Snooping**, **IP Source Guard**, and **Dynamic ARP Inspection**.

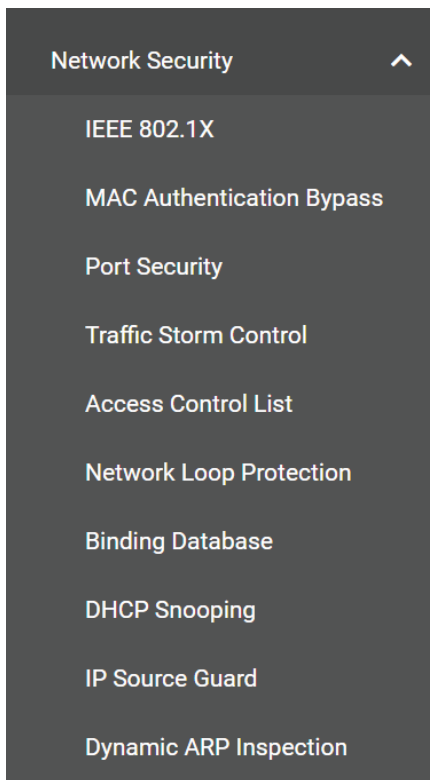

IEEE 802.1X

Port-based IEEE 802.1X Overview

The IEEE 802.1X standard defines a protocol for client/server-based access control and authentication. The protocol restricts unauthorized clients from connecting to a LAN through ports that are open to the Internet, and which otherwise would be readily accessible. The purpose of the authentication server is to check each client that requests access to the port. The client is only allowed access to the port if the client's permission is authenticated.

Three components are used to create an authentication mechanism based on 802.1X standards: Client/Supplicant, Authentication Server, and Authenticator.

Client/Supplicant: The end station that requests access to the LAN and switch services and responds to the requests from the switch.

Authentication Server: The server that performs the actual authentication of the supplicant.

Authenticator: Edge switch or wireless access point that acts as a proxy between the supplicant and the authentication server, requesting identity information from the supplicant, verifying the information with the authentication server, and relaying a response to the supplicant.

The Moxa switch acts as an authenticator in the 802.1X environment. A supplicant and an authenticator exchange EAPOL (Extensible Authentication Protocol over LAN) frames with each other. We can either use an external RADIUS server as the authentication server or implement the authentication server in the Moxa switch by using a Local User Database as the authentication look-up table. When we use an external RADIUS server as the authentication server, the authenticator and the authentication server exchange EAP frames.

Authentication can be initiated either by the supplicant or the authenticator. When the supplicant initiates the authentication process, it sends an **EAPOL-Start** frame to the authenticator. When the authenticator

initiates the authentication process or when it receives an **EAPOL Start** frame, it sends an **EAP Request/Identity** frame to ask for the username of the supplicant.

How IEEE 802.1X Works

802.1X authentication requires three parties: a supplicant, an authenticator, and an authentication server. The supplicant is a client device that wishes to connect to the LAN or WLAN. The supplicant can also use the software to run on the client that offers credentials to the authenticator. Network administrators usually use an Ethernet switch or wireless access point as the authenticator, and running software supporting RADIUS and EAP protocols in the authentication server.

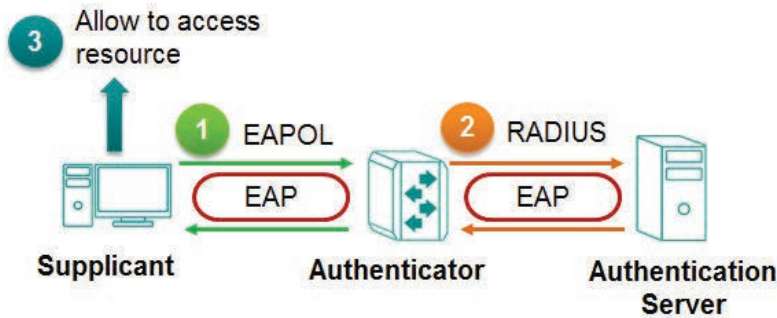

The authenticator serves as a security guard to a protected network. The supplicant is not allowed access through the authenticator to the protected side of the network unless the supplicant's identity has been validated and authorized. With 802.1X port-based authentication, the supplicant provides credentials, such as user name/password or digital certificate, to the authenticator, and the authenticator transmits the credentials to the authentication server for verification. If the authentication server approves the credentials as valid, the supplicant (client device) is allowed to access resources located on the protected side of the network.

IEEE 802.1X Settings

Click **IEEE802.1X** on the menu and then select the **General** tab.

IEEE 802.1X

General
RADIUS
Local Database

IEEE 802.1X *
Disabled ▼

Authentication Mode *
Local Database ▼

APPLY

Configure the following settings.

IEEE 802.1X





Setting	Description	Factory Default
Enabled	Enable IEEE 802.1X.	Disabled
Disabled	Disable IEEE 802.1X.	

Authentication Mode

Setting	Description	Factory Default
Local Database	Use the local database as the authentication mode.	Local Database
RADIUS	Use the RADIUS as the authentication mode.	

When finished, click **APPLY** to save your changes.

To configure the IEEE 802.1X settings for the specific port, click  icon on the port.

	Port	Enable	Port Control	Max. Request	Quiet Period	Reauthentication
	1/1	Disabled	Auto	2	60	Disabled
	1/2	Disabled	Auto	2	60	Disabled
	1/3	Disabled	Auto	2	60	Disabled
	1/4	Disabled	Auto	2	60	Disabled

Configure the following settings.

Port 1/1 Settings

Enabled *
Disabled ▼

Port Control *
Auto ▼

Max. Request * Quiet Period *
2 60

1 - 10 times 0 - 65535 sec.

Reauthentication * Reauth Period *
Disabled ▼ 3600

1 - 65535 sec.

Server Timeout *
30

1 - 65535 sec.

Supp Timeout *
30

1 - 65535 sec.

Tx Period *
30

1 - 65535 sec.

Copy Configurations ... ▼ 

CANCEL APPLY

Enable

Setting	Description	Factory Default
Enabled	Enable IEEE 802.1X.	Disabled
Disabled	Disable IEEE 802.1X.	

Port Control

Setting	Description	Factory Default
Force Unauthorized	The controlled port has to be held in the Unauthorized state.	Auto
Auto	The controlled port is set to the authorized or unauthorized state in accordance with the outcome of an authentication exchange between the Supplicant and the Authentication Server.	
Force Authorized	The controlled port is required to be held in the authorized state.	

Max Request (times)

Setting	Description	Factory Default
1 to 10	Specify how many times for re-authentication.	2

Quiet Period (sec.)

Setting	Description	Factory Default
0 to 65535	Specify the duration of time that the switch remains in the quiet state following a failed authentication exchange with the client.	60

Reauthentication

Setting	Description	Factory Default
Enabled	Enable re-authentication.	Disabled
Disabled	Disable re-authentication.	

Reauth Period (sec.)

Setting	Description	Factory Default
1 to 65535	Input the duration of time between re-authentication attempts.	3600

Server Timeout (sec.)

Setting	Description	Factory Default
1 to 65535	Input the duration of time that the switch will re-transmit the packets from the switch to the authentication server.	30

Supp (Supplicant, such as Client PC) Timeout (sec.)

Setting	Description	Factory Default
1 to 65535	Input the duration of time that the switch will re-transmit the packets from the switch to the client.	30

Tx Period (sec.)

Setting	Description	Factory Default
1 to 65535	Input the duration of time that the switch will re-transmit the data to the client.	30

Copy Configurations to Ports

Setting	Description	Factory Default
Select the port(s) from the drop-down list	Allows users to copy configurations to other port(s).	None

When finished, click **APPLY** to save your changes.

IEEE 802.1X Database

RADIUS

RADIUS **Remote Authentication Dial in User Service** is a protocol that involves three services in one network protocol: Authentication, Authorization, and Accounting (AAA). The protocol operates on port 1812, and provides AAA management for users connecting to a network service.

RADIUS is based on a client/server protocol that runs in the application layer, and can use either TCP or UDP as the mode of transport. The network access servers that contain the RADIUS protocol can allow the client to communicate with the RADIUS server. Through Authentication, Authorization, and Accounting, RADIUS is used to monitor access to the network.

To configure RADIUS settings, click the **RADIUS** tab.

IEEE 802.1X

General
RADIUS
Local Database

802.1X and MAC Authentication Bypass share the same RADIUS server.

Server IP Address 1 Auth Port

1 - 65535

Share Key

0 / 46

Timeout

1 - 120 sec.

Retransmit

1 - 254 times

Server IP Address 2 Auth Port

1 - 65535

Share Key

0 / 46

Timeout

1 - 120 sec.

Retransmit

1 - 254 times

APPLY

Configure the following settings.

Server Address 1

Setting	Description	Factory Default
To input server address 1	Specify the 1st server address.	None

Auth Port

Setting	Description	Factory Default
1 to 65535	Specify the authentication port number for the 1st server address.	None

Share Key

Setting	Description	Factory Default
Input the share key for the 1st server, (0 to 46)	Specify the share key for the 1st server.	None

Timeout (sec.)

Setting	Description	Factory Default
1 to 120	Specify the duration of time before a device is logged out.	None

Retransmit (sec.)

Setting	Description	Factory Default
1 to 254	Specify how many times for data re-transmission.	None

Server Address 2

Setting	Description	Factory Default
To input server address 2	Specify the 2nd server address.	None

Auth Port

Setting	Description	Factory Default
1 to 65535	Specify the authentication port number for the 2nd server address.	None

Share Key

Setting	Description	Factory Default
Input the share key for the 2nd server (0 to 46)	Specify the share key for the 2nd server.	None

Timeout

Setting	Description	Factory Default
1 to 120	Specify the duration of time before the device is timed out.	None

Retransmit (sec.)

Setting	Description	Factory Default
1 to 254	Specify the time for data re-transmission.	None

When finished, click **APPLY** to save your changes.



NOTE

The RADIUS service will be operated via the 1st server first; if it fails, it will be run on the 2nd server.

Local Database

First click the **Local Database** tab and then click the  icon.

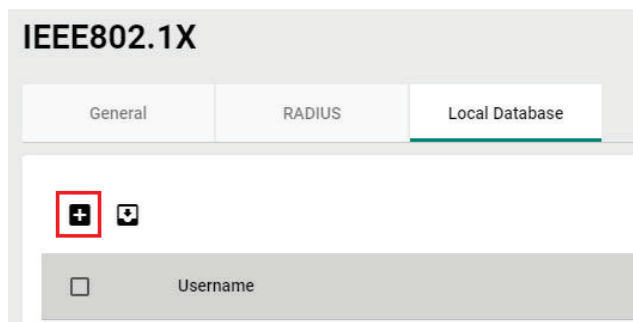

Configure the following settings.

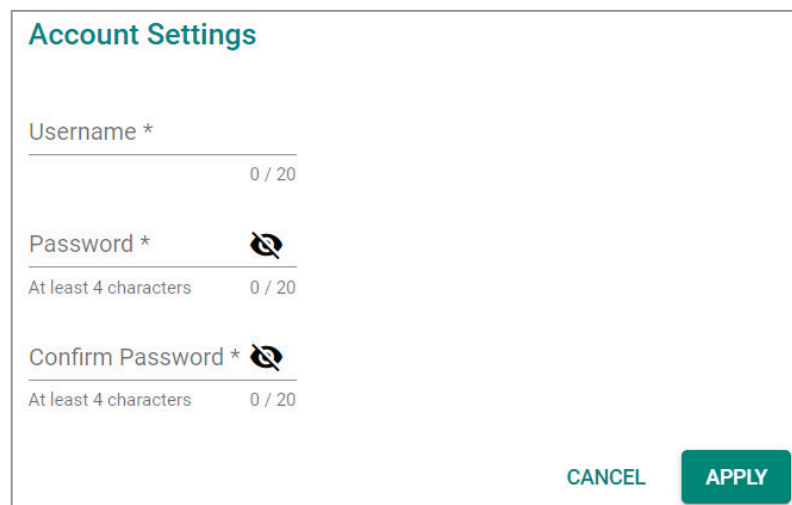

Username

Setting	Description	Factory Default
0 to 20 characters	Specify the username for the local database.	None

Password

Setting	Description	Factory Default
At least 4 characters, (max. 20 characters)	Specify the password for the local database user.	None

Confirm Password

Setting	Description	Factory Default
At least 4 characters, (max. 20 characters)	Confirm the password for the local database user.	None

When finished, click **APPLY** to save your changes.

MAC Authentication Bypass

Click **MAC Authentication Bypass** on the function menu.

General

Click the **General** tab for general settings.

The screenshot shows the 'MAC Authentication Bypass' configuration interface. At the top, there are three tabs: 'General', 'RADIUS', and 'Local Database'. The 'General' tab is active. Below the tabs, there are two dropdown menus: 'MAC Authentication ...' and 'Authentication Mode *'. At the bottom left of the configuration area, there is a green 'APPLY' button.

MAC Authentication Bypass

Setting	Description	Factory Default
Enabled	Enable MAC authentication bypass function.	None
Disabled	Disable MAC authentication bypass function.	

Authentication Mode

Setting	Description	Factory Default
RADIUS	Select RADIUS as the authentication mode.	None
Local Database	Select local database as the authentication mode.	

When finished, click **APPLY** to save your changes.

RADIUS

Click the **RADIUS** tab to perform further configurations.

MAC Authentication Bypass

General
RADIUS
Local Database

Server Address 1

Auth Port

Share Key

Timeout sec.

Retransmit sec.

Server Address 2

Auth Port

Share Key

Timeout sec.

Retransmit sec.

APPLY

Configure the following settings.

Server Address 1

Setting	Description	Factory Default
To input server address 1	Specify the 1st server address.	None

Auth Port

Setting	Description	Factory Default
1 to 65535	Specify the authentication port number for the 1st server address.	None

Share Key

Setting	Description	Factory Default
Input the share key for the 1st server, (0 to 46)	Specify the share key for the 1st server.	None

Timeout (sec.)

Setting	Description	Factory Default
1 to 120	Specify the duration of time before a device is logged out.	None

Retransmit (sec.)

Setting	Description	Factory Default
1 to 254	Specify the time for data re-transmission.	None

Server Address 2

Setting	Description	Factory Default
To input server address 2	Specify the 2nd server address.	None

Auth Port

Setting	Description	Factory Default
1 to 65535	Specify the authentication port number for the 1st server address.	None

Share Key

Setting	Description	Factory Default
Input the share key for the 2nd server (0 to 46)	Specify the share key for the 2nd server.	None

Timeout

Setting	Description	Factory Default
1 to 120	Specify the duration of time before the device is timed out.	None

Retransmit (sec.)

Setting	Description	Factory Default
1 to 254	Specify the time for data re-transmission.	None

When finished, click **APPLY** to save your changes.



NOTE



The RADIUS service will be operated via the 1st server first; if it fails, it will be run on the 2nd server.

Local Database

Click **Local Database** tab, and then click  icon for further configurations.

MAC Authentication Bypass

General RADIUS **Local Database**

MAC Address

Max. 1024

Configure the following setting.

Create Entry

MAC Address * i

CANCEL CREATE

MAC Address

Setting	Description	Factory Default
MAC Address	Specify the MAC address used for MAC authentication bypass.	None

When finished, click **CREATE** to complete.

Port Security

MAC Sticky Overview

MAC Sticky is a function that allows users to configure the maximum number of MAC addresses (the Limit) that a port can "learn". Users can configure what action should be taken (under Secure Action) when a new MAC address tries to access a port after the maximum number of MAC addresses have already been learned. The total number of allowed MAC addresses cannot exceed 1024.

How MAC Sticky Works

In MAC Sticky mode, administrators can set a proper limit number and then configure trust devices manually, or let the system configure trust devices automatically. Except for dropping packets as a response to any violations, administrators can set 'port shutdown' on a port and achieve a strict security guarantee. When a violation is registered on a port, the port will shut down and an administrator will receive a notification to perform a check.

MAC Sticky Settings and Status

To configure the MAC Sticky settings, select the **General** tab in **Port Security**.

Configure the following settings.

Port Security

Setting	Description	Factory Default
Enabled	Enable port security.	Enabled
Disabled	Disable port security.	

Port Security Mode

Setting	Description	Factory Default
MAC Sticky	Specify MAC Sticky as the port security mode.	Static Port Lock
Static Port Lock	Specify Static Port Lock as the port security mode.	

Select **MAC Sticky** and click **Apply**.







NOTE

When you change the Port Security Mode, the settings in the table will be deleted.

Click the  icon on the port you want to edit.



	Port	Enable	Address Limit	Secure Action	Current Address
	1/1	Disabled	1	Packet Drop	0
	1/2	Disabled	1	Packet Drop	0
	1/3	Disabled	1	Packet Drop	0
	1/4	Disabled	1	Packet Drop	0

Configure the following settings.

MAC Sticky

Setting	Description	Factory Default
Enabled	Enable MAC Sticky for this port.	Disabled
Disabled	Disable MAC Sticky for this port.	

Address Limit

Setting	Description	Factory Default
1 to 997	Specify the maximum numbers of the learned MAC address.	1

Secure Action

Setting	Description	Factory Default
Port Shutdown	Enable port shutdown when a violation occurs.	Packet Drop
Packet Drop	Drop the packets when a violation occurs.	

When finished, click **Apply** to save your changes.

Next, click the **MAC Sticky** tab, and then click the  icon to add the MAC Sticky entries.

Configure the following settings.

Create Entry

Port ▼

VLAN ID *

MAC Address * i

Cancel
Create

Port

Setting	Description	Factory Default
Select the port from the drop-down list	Select the port(s) that will be used with the MAC Sticky function.	None

VLAN ID

Setting	Description	Factory Default
Input the VLAN ID	Specify the VLAN ID that will be used with MAC Sticky.	None

MAC Address

Setting	Description	Factory Default
Input the MAC address that will be used	Specify the MAC Address of the device that will be used as the reliable source for network access.	None

When finished, click **Create**.

You can view the MAC Sticky settings in the figure below.

Port Security

General

MAC Sticky

Port Security Mode
MAC Sticky

Total Trust Hosts
1

System Max. Address
1024

+
↻
+

<input type="checkbox"/>	Port	VLAN	MAC Address	Type	Effective
<input type="checkbox"/>	3/4	1	c8.cb:b8:02:26:5f	Sticky Dynamic	Yes

Static Port Lock Overview

To provide a port-based security function, Moxa's switches have implemented Static Port Lock function; the main idea is to allow configured devices, 128 at most, to access the network through a specific port. Packets sent from unknown devices or from configured devices with mismatching ports will be dropped. In other words, only the packets from the devices pre-configured with the specific MAC addresses can be sent to the specific port to ensure a secured network data transmission scenario.

Static Port Lock Settings and Status

To configure these setting, first click the **Port Security** tab and then click **General**.

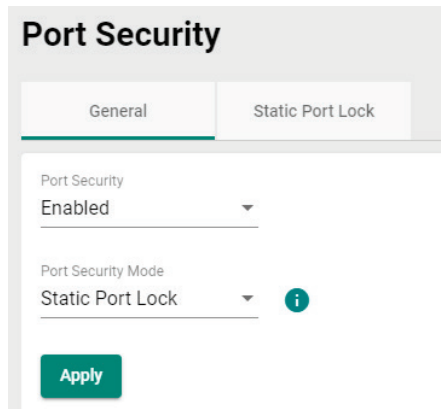

Port Security

General Static Port Lock

Port Security
Enabled

Port Security Mode
Static Port Lock *i*

Apply

Configure the following settings.

Port Security





Setting	Description	Factory Default
Enabled	Enable port security.	Enabled
Disabled	Disable port security.	

Port Security Mode

Setting	Description	Factory Default
MAC Sticky	Select MAC Sticky as the port security mode.	Static Port Lock
Static Port Lock	Select Static Port Lock as the port security mode.	

Select **Static Port Lock** and click **Apply**.

Select the  icon on the port you want to edit.

	Port	Enable	Manual Configured Address
	1/1	Disabled	0
	1/2	Disabled	0
	1/3	Disabled	0
	1/4	Disabled	0

Configure the following settings.

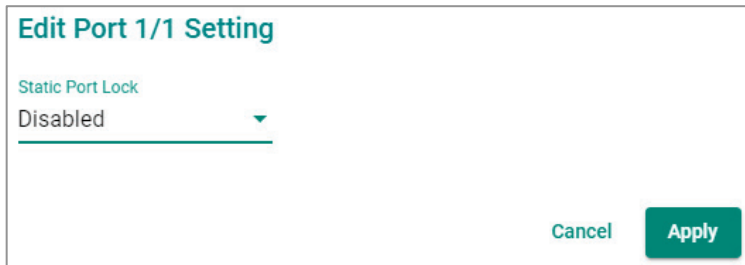

Edit Port 1/1 Setting

Static Port Lock
Disabled

Cancel Apply

Static Port Lock

Setting	Description	Factory Default
Enabled	Enable Static Port Lock.	Disabled
Disabled	Disable Static Port Lock.	

When finished, click **Apply** to save your changes.

Next, click the **Static Port Lock** tab and then the  icon to perform further settings.

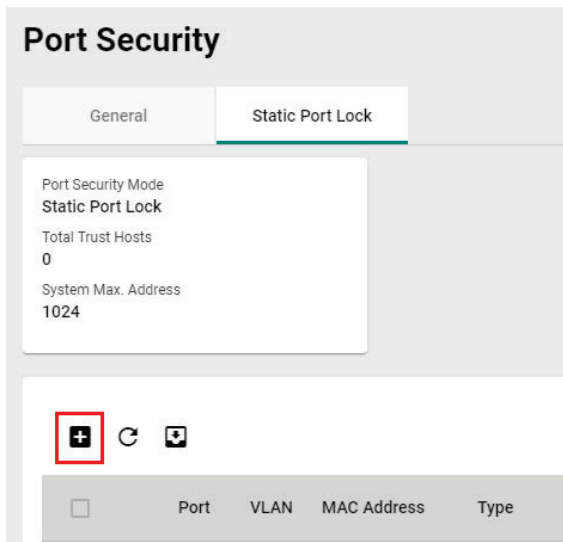



Port Security

General Static Port Lock

Port Security Mode
Static Port Lock

Total Trust Hosts
0

System Max. Address
1024

<input type="checkbox"/>	Port	VLAN	MAC Address	Type
--------------------------	------	------	-------------	------

Configure the following settings.

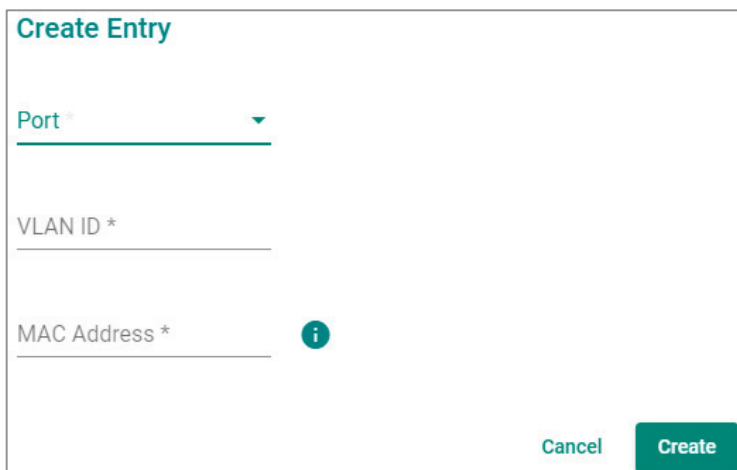

Create Entry

Port

VLAN ID *

MAC Address * 

Cancel Create

Port

Setting	Description	Factory Default
Select the port from the drop-down list	Specify the port(s) that will be used with Static Port Lock.	None

VLAN ID

Setting	Description	Factory Default
Input the VLAN ID	Specify the VLAN ID that will use Static Port Lock.	None

MAC Address

Setting	Description	Factory Default
Input the MAC address that will be used	Specify the MAC Address of the device that will be used as the reliable source for network access.	None

When finished, click **Create**.

You can view the **Static Port Lock** setting status from the following figure.

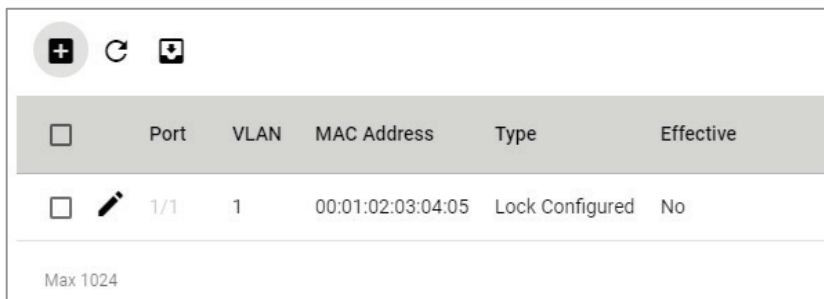

<input type="checkbox"/>	Port	VLAN	MAC Address	Type	Effective
<input type="checkbox"/>	1/1	1	00:01:02:03:04:05	Lock Configured	No





Max 1024

Traffic Storm Control

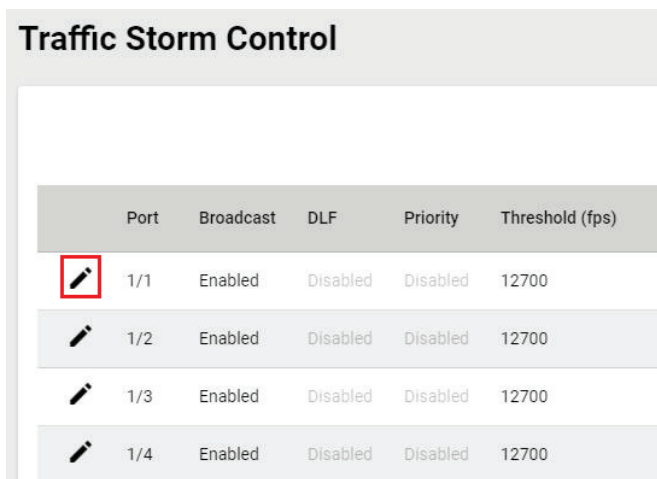
A traffic storm can happen when packets flood the network; this causes excessive traffic and slows down the network performance. To counter this, Traffic Storm Control provides an efficient design to prevent the network from flooding caused by a broadcast, multicast, or unicast traffic storm on a physical network layer. The feature can handle packets from both ingress and egress data.

First click **Traffic Storm Control** on the menu, and then click the  icon on the specific port you want to configure.



	Port	Broadcast	DLF	Priority	Threshold (fps)
	1/1	Enabled	Disabled	Disabled	12700
	1/2	Enabled	Disabled	Disabled	12700
	1/3	Enabled	Disabled	Disabled	12700
	1/4	Enabled	Disabled	Disabled	12700

Configure the following settings.

Edit Port 1/1 Settings

Broadcast *
Enabled ▼

Multicast *
Disabled ▼

DLF *
Disabled ▼

Threshold *
12700 ⓘ
625 - 14881000 fps

Copy Configurations ... ⓘ

CANCEL
APPLY

There are three methods that can be used for traffic storm control: Broadcast, Multicast, and Destination Lookup Failure (DLF).

Broadcast

Setting	Description	Factory Default
Enabled	Enable traffic storm control for broadcast packets on the port.	Disabled
Disabled	Disable traffic storm control for broadcast packets on the port.	

Multicast

Setting	Description	Factory Default
Enabled	Enable traffic storm control for multicast packets on the port.	Disabled
Disabled	Disable traffic storm control for multicast packets on the port.	

DLF

Setting	Description	Factory Default
Enabled	Enable traffic storm control for DLF packets on the port.	Disabled
Disabled	Disable traffic storm control for DLF packets on the port.	

Threshold (fps)

Setting	Description	Factory Default
625 to 14881000	Define the threshold for a traffic storm.	12700

Copy Configurations to Ports

Setting	Description	Factory Default
Select the port(s) from the drop-down list	Select the port(s) you want to have the same configurations for.	None

When finished, click **APPLY** to save your changes.

Access Control List

Click **Access Control List** on the function menu and then click  to perform further configurations.

Access Control List

Settings
Status

Access Control List



<input type="checkbox"/>	Index	Name
Max. 32		

Create an Access List

Access List Type * i

Index * i

Name

0 / 127

CANCEL
CREATE

Configure the following settings.

Access List Type

Setting	Description	Factory Default
IP-based	Specify IP-based as the access list type.	None
MAC-based	Specify MAC-based as the access list type.	

Index (For IP-based type)

Setting	Description	Factory Default
Select from IP-1 to IP-16	Select from the drop-down list for index.	None

Index (For MAC-based type)

Setting	Description	Factory Default
Select from MAC-1 to MAC-16	Select from the drop-down list for index.	None

Name

Setting	Description	Factory Default
0 to 127 characters	Provide a name for this access list.	None

IP-based ACL Table Configurations

Configure the following settings for IP-based access list.

ACL Table of IP-1 ▼

Active Interface Type *

Port-based ▼

Active Ingress Ports ▼ ⓘ

Active Egress Ports ▼ ⓘ

APPLY

Active Interface Type

Setting	Description	Factory Default
Port-based	Specify Port-based as the active interface type.	None
VLAN-based	Specify VLAN-based as the active interface type.	

Active Ingress Ports (For Port-based type)

Setting	Description	Factory Default
Select the port(s) from the drop-down list	Select the port(s) as the active ingress port(s).	None

Active Egress Ports (For Port-based type)

Setting	Description	Factory Default
Select the port(s) from the drop-down list	Select the port(s) as the active egress port(s).	None

Active Ingress VLAN (For VLAN-based type)

Setting	Description	Factory Default
Select the port(s) from the drop-down list	Select the port(s) as the active ingress VLAN.	None

Active Egress VLAN (For VLAN-based type)

Setting	Description	Factory Default
Select the port(s) from the drop-down list	Select the port(s) as the active egress VLAN.	None

When finished, click **APPLY** to save your changes.

IP-based Rule Index Settings

Click the  icon for Rule Index settings.



Create Rule Index 1 Settings of IP-1

Rule Index 1 *
Enabled ▼

Rule Type *
▼

Protocol
Any ▼

Source IP Address
Any Source IP Mask ▼

Destination IP Address
Any Destination IP Mask ▼

DSCP
Any
0 - 63

CANCEL
CREATE

Configure the following settings.

Rule Index 1

Setting	Description	Factory Default
Enabled	Enable Rule Index 1 settings.	Enabled
Disabled	Disable Rule Index 1 settings.	

Rule Type

Setting	Description	Factory Default
Permit	Specify the rule type as Permit.	None
Deny	Specify the rule type as Deny.	

Protocol

Setting	Description	Factory Default
Select the port(s) from the drop-down list	Select the protocol used for this rule index.	Any

ICMP Type (For ICMP protocol only)

Setting	Description	Factory Default
0 to 255	Select the ICMP type value.	Any

ICMP Code (For ICMP protocol only)

Setting	Description	Factory Default
0 to 15	Select the ICMP code value.	Any

IGMP Type (For IGMP protocol only)

Setting	Description	Factory Default
0 to 255	Select the IGMP type value.	Any

Protocol Number (For User defined protocol only)

Setting	Description	Factory Default
0 to 255	Select the protocol number.	None

Source IP Address

Setting	Description	Factory Default
IP address	Provide the IP address as the source IP address.	Any

Source IP Mask

Setting	Description	Factory Default
Select the port(s) from the drop-down list	Select the source IP mask from the list.	None

Source Port

Setting	Description	Factory Default
Select the port(s) by using the up/down arrow	Select the source port.	Any

Destination IP Address

Setting	Description	Factory Default
IP address	Provide the IP address as the destination IP address.	Any

Destination IP Mask

Setting	Description	Factory Default
Select the port(s) from the drop-down list	Select the destination IP mask from the list.	None

Destination Port

Setting	Description	Factory Default
Select the port(s) by using the up/down arrow	Select the destination port.	Any

DSCP

Setting	Description	Factory Default
0 to 63	Specify the DSCP value.	Any

Action-Redirect Enable

Setting	Description	Factory Default
Enabled	Enable the redirection function.	Disabled
Disabled	Disabled the redirection function.	

DSCP Remark

Setting	Description	Factory Default
0 to 63	Specify the DSCP remark value.	Disabled

When finished, click **CREATE** to complete.

Note that the following system packets are not included in the ACL operation.

Item	Destination/Source Port Number
DHCP Server	67
DHCP Client	68
Moxa Service	40404

MAC-based ACL Table Configurations

Configure the following settings for MAC-based access list.

ACL Table of MAC-1 ▼

Active Interface Type *

Port-based ▼

Active Ingress Ports ▼ ⓘ

Active Egress Ports ▼ ⓘ

APPLY

Active Interface Type

Setting	Description	Factory Default
Port-based	Specify Port-based as the active interface type.	None
VLAN-based	Specify VLAN-based as the active interface type.	

Active Ingress Ports (For Port-based type)

Setting	Description	Factory Default
Select the port(s) from the drop-down list	Select the port(s) as the active ingress port(s).	None

Active Egress Ports (For Port-based type)

Setting	Description	Factory Default
Select the port(s) from the drop-down list	Select the port(s) as the active egress port(s).	None

Active Ingress VLAN (For VLAN-based type)

Setting	Description	Factory Default
Select the port(s) from the drop-down list	Select the port(s) as the active ingress VLAN.	None

Active Egress VLAN (For VLAN-based type)

Setting	Description	Factory Default
Select the port(s) from the drop-down list	Select the port(s) as the active egress VLAN.	None

When finished, click **APPLY** to save your changes.

MAC-based Rule Index Settings

Click the  icon for Rule Index settings.



Create Rule Index 1 Settings of MAC-1

Rule Index 1 *
Enabled ▾

Rule Type *
▾

EtherType
Any ▾

Source MAC Address
Any

Source MAC Mask ▾

Destination MAC Address
Any

Destination MAC Ma... ▾

VLAN ID
Any
1 - 4094

CoS
Any
0 - 7

CANCEL CREATE

Configure the following settings.

Rule Index 1

Setting	Description	Factory Default
Enabled	Enable Rule Index 1 settings.	Enabled
Disabled	Disable Rule Index 1 settings.	

Rule Type

Setting	Description	Factory Default
Permit	Specify the rule type as Permit.	None
Deny	Specify the rule type as Deny.	

EtherType

Setting	Description	Factory Default
GOOSE (RKS, MDS only)	Select GOOSE as the Ethernet type.	Any
SMV (RKS, MDS only)	Select SMV as the Ethernet type.	
User defined	Select User defined as the Ethernet type.	

EtherType Value (For User defined type only)

Setting	Description	Factory Default
In hex digit	Provide the Ethernet type value for the user defined type.	0x

Source MAC Address

Setting	Description	Factory Default
MAC address	Provide the MAC address as the source MAC address.	Any

Source MAC Mask

Setting	Description	Factory Default
Select the port(s) from the drop-down list	Select the source MAC mask from the list.	None

Destination MAC Address

Setting	Description	Factory Default
MAC address	Provide the MAC address as the destination MAC address.	Any

Destination MAC Mask

Setting	Description	Factory Default
Select the port(s) from the drop-down list	Select the destination MAC mask from the list.	None

VLAN ID

Setting	Description	Factory Default
Select the VLAN ID by using the up/down arrows	Select the VLAN ID.	Any

CoS (RKS, MDS only)

Setting	Description	Factory Default
Select the Cos value by using the up/down arrows	Specify the CoS value.	Any

When finished, click **CREATE** to complete.

Note that the following system packets are not included in the ACL operation.

For RKS-G4000 Series, MDS-G4000 Series, MDS-G4000-4XGS Series:

Item	MAC Address
IEEE reserved Multicast MAC address	01:80:C2:00:00:XX

Item	Ether Type
LLDP	0x88CC
EAPOL	0x888E
LACP	0x8809
LLC Jumbo frame	0x8870
ARP	0x0806
MRP	0x88E3
PROFINET	0x8892
PTP	0x88B5
PTP	0x88F7

For EDS-(G)4000 Series:

Item	MAC Address
IEEE reserved Multicast MAC address	01:80:C2:00:00:XX
IP Multicast MAC Address - IGMP snooping (MAC-based)	01:00:5E:XX:XX:XX
Broadcast MAC Address - IGMP snooping (MAC-based)	FF:FF:FF:FF:FF:FF
L2 Multicast MAC Address - IGMP snooping (MAC-based)	01:XX:XX:XX:XX

Item	Ether Type
LLDP	0x88CC
EAPOL	0x888E
LACP	0x8809
LLC Jumbo frame	0x8870
ARP	0x0806
MRP	0x88E3

Item	Ether Type
PROFINET	0x8892
PTP	0x88B5
PTP	0x88F7
GOOSE	0x88B8
SMV	0x88BA
Ethernet Configuration Testing Protocol	0x9000

Access Control List Status

Click **Status** tab to view the Access Control List status.

Access Control List

Settings
Status

ACL Summary

Number of activate ACL (Max. 16)
1

Access Control List

Index	Name	Activated	Activate Direction
MAC-1	test	Inactivated	--
IP-1	test	Activated	Both

Network Loop Protection

Click **Network Loop Protection** on the function menu.

Overview

Network Loop Protection is designed to avoid loops by disabling ports when looping is detected in the network topology. The feature is designed for devices that do not support redundant protocols, do not configure redundant protocols, or the redundant protocol fails for a reason.

How Network Loop Protection works

Network Loop Protection prevents looping by sending the detection packet through the network topology to all ports. After receiving a packet, the port will check if the packet was sent by the device itself. If yes, the receiving port will be disabled.

Network Loop protection features cannot prevent ports activating redundant protocols, such as STP/RSTP/MSTP/Turbo Ring/Ring Coupling/Turbo Chain/Dual Homing or Link Aggregation from looping, as these ports do not process detected packets sent by Network Loop protection.

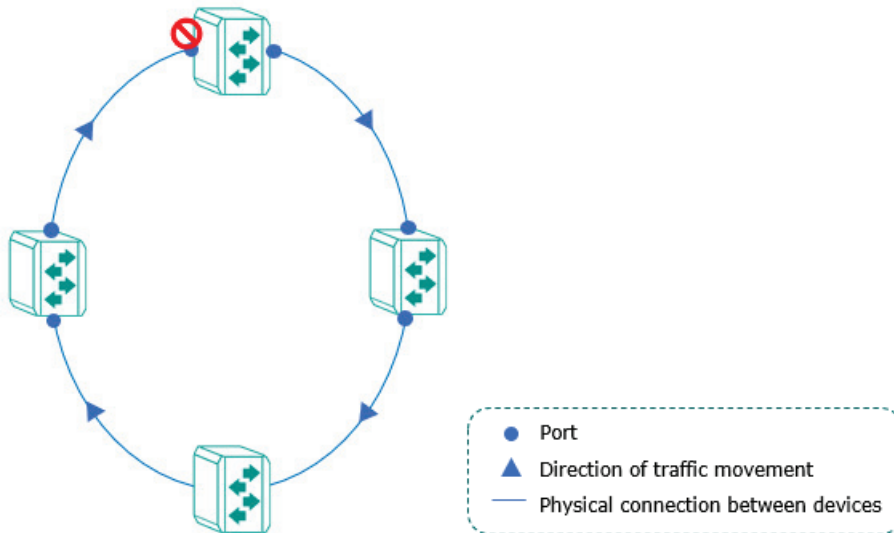

Settings

Click the **Settings** tab for further configurations.

Network Loop Protection

Settings
Status

Network Loop Protection *

Disabled ▼

Detect Interval *

10

1 - 30 sec.

APPLY

Configure the following settings.

Network Loop Protection

Setting	Description	Factory Default
Enabled	Enable the Network Loop Protection function.	Disabled
Disabled	Disable the Network Loop Protection function.	

Detect Interval





Setting	Description	Factory Default
1 to 30	Specify the detect interval value.	10

When finished, click **APPLY** to complete.

Status

Click **Status** tab to view the Loop Protection status.

Network Loop Protection

Settings	Status		
			
Ports	Loop Status	Port Status	Peer Port
 1/1	Normal	--	--
 1/2	Normal	--	--
 1/3	Normal	--	--
 1/4	Normal	--	--

Binding Database

A Binding Database is analogous to an allow list for IP Source Guard and Dynamic ARP Inspection.

A Binding Database consists of Dynamic Entries and Static Entries.

- **Dynamic:** Generated automatically after the DHCP client successfully obtains the IP while DHCP Snooping enabled. The entry will be released after exceeding the IP lease time or upon disabling DHCP Snooping.
- **Static:** User-generated/edited entry. The entry will be released only when users delete it.

Binding Database Dynamic Entries are maintained by successful DHCP transactions on DHCP Snooping Untrusted ports and allow users to manually specify static entries. Binding Database Entries consist of VLAN IDs, MAC Addresses, Ports, and IP Addresses. This information constitutes the allow list used by IP Source Guard to filter IP packets and for Dynamic ARP Inspection to filter the ARP packets, helping prevent spoofing attacks (Man-in-the-middle, Denial-of-service, etc.).

The Binding Database may have a maximum of 32 entries.

Configuring Binding Databases

Before you begin: Determine which kind of Binding Database Entries to use: Static, or Dynamic. See above for guidelines to make this determination.

Configuring Dynamic Binding Database Entries

To configure a Dynamic Binding Database entry:

1. Go to **Security > Network Security > DHCP Snooping**.
2. Click DHCP Snooping and then select **Enable**, optionally specify a VLAN ID, and then click **Apply**.
3. Under Port Settings, click ****Edit**** (Pencil Icon) to configure the corresponding port binding settings.
4. Configure the following:
 - **Status**
 - **Copy configurations to ports**
5. Click **Apply**

Results: The Binding Database entries will be created upon a successful DHCP transaction on DHCP Snooping-enabled Untrusted ports. You can view the binding database entries by going to **Security > Network Security > Binding Database > Binding Status**.

Configuring Static Binding Database Entries

To configure a Static Binding Database Entry:

1. Go to **Security > Network Security > Binding Database.> Binding Setting.**
2. Click **+** (**Add**), and then specify all of the following:
 - **VLAN ID**
 - **MAC Address**
 - **Port**
 - **IP Address**
3. Click **Create** to add the entry to the database.

Results: The Binding Database entries will be created upon a successful DHCP transaction on DHCP Snooping-enabled Untrusted ports. You can view the binding database entries by going to **Security > Network Security > Binding Database > Binding Status.**

Create a Binding Database Static Entry

VLAN ID * MAC Address *

Port *

IP Address *



NOTE

The maximum number of entries for the Binding Database—including Dynamic entries and Static entries—is 32. Entries will stop generating or being user-addable when the total entry reaches the maximum entry limit. More entries can only be added when existing entries are released, bringing the total number below 32.

VLAN ID

Setting	Description	Factory Default
1 to 4094	Input a VLAN ID.	None

MAC Address

Setting	Description	Factory Default
MAC address	Specify the MAC address for the entry.	None

Port

Setting	Description	Factory Default
Select the port from the list	Select the port for the entry.	None

IP Address

Setting	Description	Factory Default
IP address	Specify the IP address for the entry.	None

When finished, click **CREATE** to save your changes.

Select the **Binding Status** tab to view the status of the database binding.

Binding Database

Binding Settings | **Binding Status**

Dynamic binding is learning from DHCP snooping.
The binding status will not be updated if the VLAN ID and MAC address combination of the static entry already exists.

↻

Type	VLAN ID	MAC Address	Port	IP Address	Lease Time
Max. 32					

DHCP Snooping

DHCP Snooping is a VLAN-specific security feature for DHCP operations. Users can configure untrusted hosts and trusted DHCP servers in the corresponding ports in the switch and then the feature will act like a firewall to validating DHCP messages received from untrusted sources and filters out the invalid messages to exclude rogue DHCP servers and remove malicious DHCP traffic to guarantee that the client obtains a legal address from the DHCP server designated by users.

To enable DHCP Snooping will also set up Binding Database and the database will act as an allowlist for IP Source Guard and Dynamic ARP Inspection.

How does DHCP Snooping work?

Configuring the designated ports connected to DHCP server ports as trusted ports and the ports connected to clients/hosts as untrusted ports:

- The trusted ports will pass all of the DHCP packets.
- The behavior for the untrusted ports are as follows:
 - a. Pass the ingress DHCP client packets and the egress DHCP server packets to complete the normal DHCP transaction.
 - b. Drop the egress DHCP client packets and the ingress DHCP server packets to avoid the rogue DHCP Server attack.
 - c. Drop DHCP client type packets with a different source MAC address and hardware address to avoid malicious DHCP client attack.

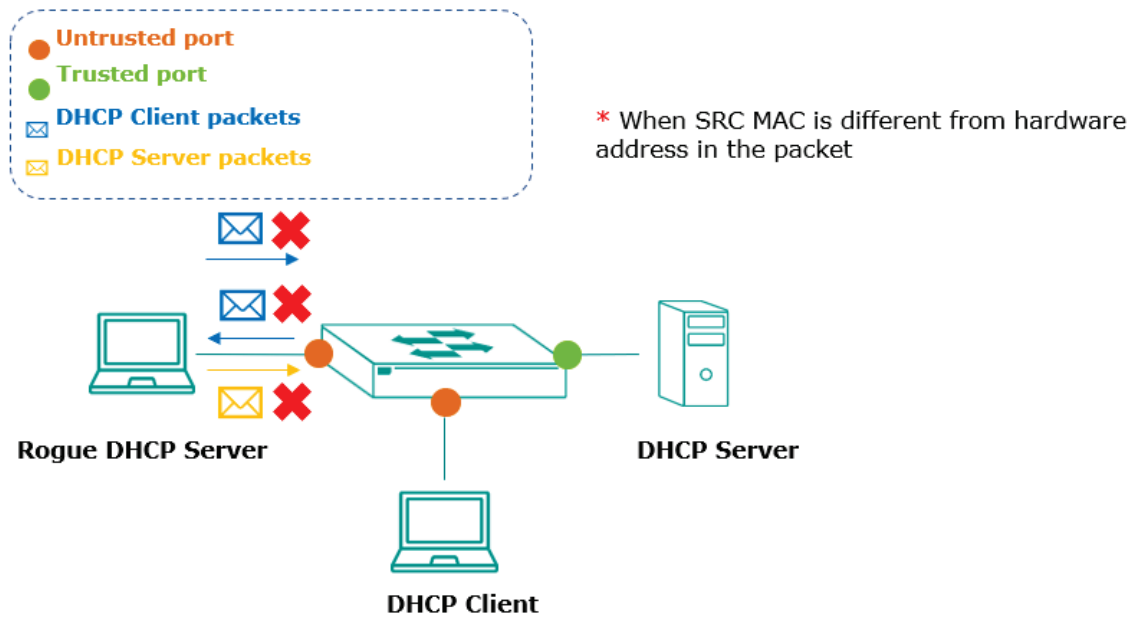

The successful DHCP transaction with DHCP Snooping enabled will create and update the Binding Database. Binding Database contains VLAN ID, MAC Address, untrusted port of DHCP clients and IP Address. Binding Database can also be used for other security functions, such as IP Source Guard and Dynamic ARP Inspection.

Click **DHCP Snooping** from the function menu and configure the following settings.

DHCP Snooping

DHCP Snooping *
Disabled

VLAN ID i
1 - 4094

APPLY

DHCP Snooping





Setting	Description	Factory Default
Enabled	Enable DHCP Snooping.	Disabled
Disabled	Disable DHCP Snooping.	

VLAN ID

Setting	Description	Factory Default
1 to 4094	Specify one or more than one VLAN ID(s).	None

When finished, click **APPLY** to save your changes.

Next, click the icon on the port you want to configure.

Port Settings		
	Port	Status
	1/1	Untrusted
	1/2	Untrusted
	1/3	Untrusted
	1/4	Untrusted

Configure the following settings.

Edit Port 1/1 Settings

Status *
Untrusted ▼

Copy configurations to ports ▼ i

CANCEL APPLY

Status

Setting	Description	Factory Default
Untrusted	Specify the port as the untrusted port.	Untrusted
Trusted	Specify the port as the trusted port.	

Copy Configurations to Port

Setting	Description	Factory Default
Select the port from the list	Copy the same configurations to other port(s).	None

When finished, click **APPLY** to save your changes.

The following steps tells you how to configure DHCP Snooping in the switch:

1. Enable DHCP Snooping globally for a specific VLAN
2. Configure the Trusted or Untrusted status for individual ports. Typically configure the ports connected to an untrusted source such as hosts as Untrusted ports (otherwise as Trusted port such as DHCP server).



NOTE

The port status cannot be changed to trusted port if Dynamic ARP Inspection or IP Source Guard is activated on the port.

IP Source Guard

IP Source Guard (IPSG) is an IP data packet filtering security feature that works on Layer 2 interfaces. The feature operates with DHCP Snooping and the Binding Database to filter the IP data packets to defend against attacks such as denial-of-service (DoS) caused by forging/spoofing source IP addresses.

How Does IP Source Guard Work?

IP Source Guard (IPSG) works with DHCP Snooping. Users must enable DHCP snooping to create the Binding Database Entry before enabling IPSG and it can only be operated in untrusted ports configured in DHCP Snooping.

IPSG examines each packet sent from a host attached to an untrusted port on the switch. The IP address, MAC address, VLAN, and port associated with the host are checked against entries stored in the Binding Database. If the packet header does not match a valid entry in the Binding Database, the switch does not forward the packet.

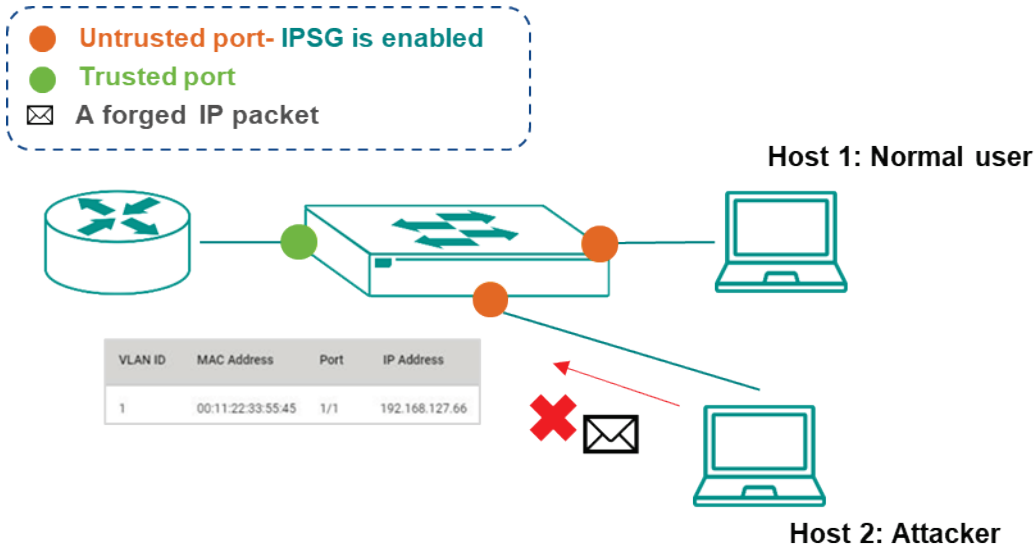

Click **IP Source Guard** on the function menu to enable the feature by individual ports or copy configurations to multiple ports. Please note IPSG can only be enabled on untrusted ports specified in DHCP Snooping feature. Click the icon on the port you want to configure.

IP Source Guard

	Port	Status
	1/1	Disabled
	1/2	Disabled
	1/3	Disabled
	1/4	Disabled

Configure the following settings.

Edit Port 1/1 Settings

Status *
Disabled ▼

Copy configurations to ports i

CANCEL
APPLY

Status

Setting	Description	Factory Default
Enabled	Enable IP Source Guard on the port. IPSG can only be enabled on untrusted ports specified in the DHCP Snooping feature.	Disabled
Disabled	Disable IP Source Guard on the port.	

Copy Configurations to Port

Setting	Description	Factory Default
Select the port from the list	Copy the same configurations to other port(s).	None

When finished, click **APPLY** to save your changes.

The following step is to configure IPSG:

Enable IPSG for individual untrusted ports specified in the DHCP Snooping feature. The IP data packet will be filtered against the IP address, MAC address, VLAN, and port recorded in the Binding Data Base Entry once the IP Source Guard has been enabled.

Dynamic ARP Inspection

Dynamic ARP Inspection (DAI) is an ARP packet filtering security feature that works on Layer 2 interfaces. The feature operates with DHCP Snooping and the Binding Database defends against attacks such as man-in-the-middle, or denial-of-service (DoS) caused by ARP packet spoofing (also known as ARP poisoning or ARP cache poisoning).

How does Dynamic ARP Inspection work?

Dynamic ARP Inspection (DAI) works with DHCP Snooping. Users must enable DHCP snooping to create the Binding Database Entry before enabling DAI and it can only operate in untrusted ports configured in the DHCP Snooping feature.

DAI inspects each packet sent from a host attached to an untrusted port on the switch. The IP address, MAC address, VLAN, and port associated with the host is checked against entries stored in the Binding Database. If the packet header does not match a valid entry in the Binding Database, the switch does not forward the packet.

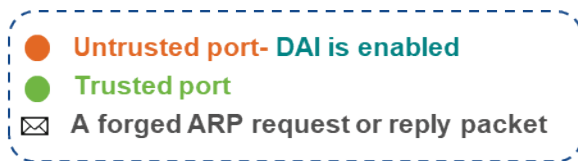



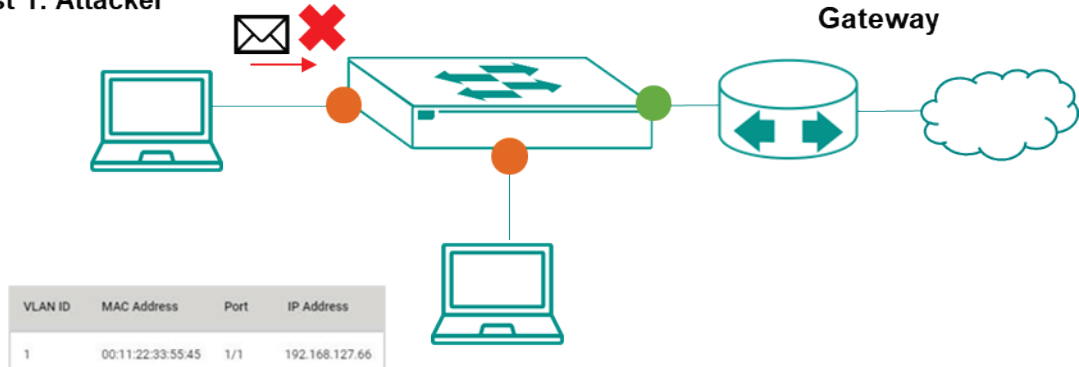

Host 1: Attacker



Host 1: Normal user

Click **Dynamic ARP Inspection** on the function menu to enable the feature by individual port or copy configurations to multiple ports. Please note DAI can only be enabled on untrusted ports specified in DHCP Snooping feature. Click the  icon on the port you want to configure.

Dynamic ARP Inspection

Port	Status
 1/1	Disabled
 1/2	Disabled
 1/3	Disabled
 1/4	Disabled

Configure the following settings.

Status

Setting	Description	Factory Default
Enabled	Enable Dynamic ARP Inspection on the port. DAI can only be enabled on untrusted ports specified in the DHCP Snooping feature.	Disabled
Disabled	Disable Dynamic ARP Inspection on the port.	

Copy Configurations to Port

Setting	Description	Factory Default
Select the port from the list	Copy the same configurations to other port(s).	None

When finished, click **APPLY** to save your changes.

The following step is to configure DAI:

Enable DAI for individual untrusted ports specified in the DHCP Snooping feature. The ARP packets will be filtered against the IP address, MAC address, VLAN, and port recorded in the Binding Data Base Entry once the DAI is enabled.

Authentication

This section describes how to configure system authentication including RADIUS and TACACS+. Moxa switches have three different user login authentications: TACACS+ (Terminal Access Controller Access-Control System Plus), RADIUS (Remote Authentication Dial In User Service), and Local. The TACACS+ and RADIUS mechanisms are centralized "AAA" (Authentication, Authorization, and Accounting) systems for connecting to network services. The fundamental purpose of both TACACS+ and RADIUS is to provide an efficient and secure mechanism for user account management.

There are five combinations available for users to choose from:

1. **TACACS+, Local:** Check the TACACS+ database first. If checking the TACACS+ database fails, then check the Local database.
2. **RADIUS, Local:** Check the RADIUS database first. If checking the RADIUS database fails, then check the Local database.
3. **TACACS+:** Only check TACACS+ database.
4. **RADIUS:** Only check the RADIUS database.
5. **Local:** Only check the Local database.

This section includes the configurations for **Login Authentication**, **RADIUS**, and **TACACS+**.

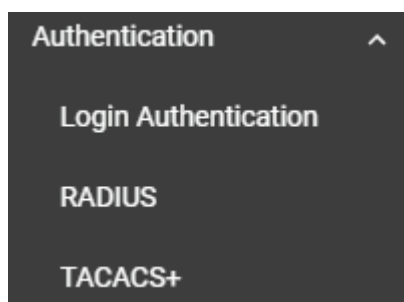

Login Authentication

This section allows users to select the login authentication protocol.

Select **Login Authentication**.

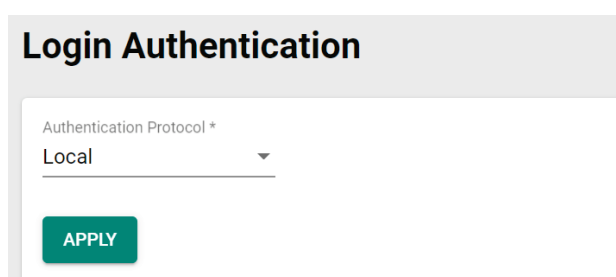
A configuration panel titled 'Login Authentication'. It features a dropdown menu labeled 'Authentication Protocol *' with 'Local' selected. Below the dropdown is a green 'APPLY' button.

Configure the following settings.

Authentication Protocol

Setting	Description	Factory Default
Local	Select Local as the authentication protocol.	Local
RADIUS	Select RADIUS as the authentication protocol.	
TACACS+	Select TACACS+ as the authentication protocol.	
RADIUS, Local	Select RADIUS and Local as the authentication protocol.	
TACACS+, Local	Select TACACS+ and Local as the authentication protocol.	

When finished, click **APPLY** to save your changes.



NOTE

The account privilege level will be granted based on the service type setting for the user for RADIUS authentication, and the privilege level for the user for TACACS+ authentication.

RADIUS Server:

- RADIUS service type = 6: Administrator
- RADIUS service type = 3: Supervisor
- RADIUS service type = all other values (1, 2, 4, 5, 7, 8, 9, 10, 11): User

TACACS+ Server:

- TACACS+ privilege level = 15: Administrator
- TACACS+ privilege level = 12: Supervisor
- TACACS+ privilege level = 1: User

RADIUS

Click **RADIUS** on the menu and configure the following settings.

RADIUS Server

Server Address 1 *
0.0.0.0

UDP Port *
1812

1 - 65535

Share Key

0 / 64

Auth Type *
CHAP

Timeout *
5

5 - 180 sec.

Retry *
1

0 - 5 times

Server Address 2 *
0.0.0.0

UDP Port *
1812

1 - 65535

Share Key

0 / 64

Auth Type *
CHAP

Timeout *
5

5 - 180 sec.

Retry *
1

0 - 5 times

APPLY

Server Address 1

Setting	Description	Factory Default
Input the server address	Specify the 1st server address as the authentication database.	0.0.0.0

UDP Port

Setting	Description	Factory Default
Input the port number	Specify the UDP port.	1812

Share Key

Setting	Description	Factory Default
Input the key	Input the share key for 1st server authentication verification.	None

Authentication Type

Setting	Description	Factory Default
PAP	PAP is the authentication type.	CHAP
CHAP	CHAP is the authentication type.	
MS-CHAPv1	MS-CHAPv1 is the authentication type.	

Timeout (sec.)

Setting	Description	Factory Default
5 to 180	When waiting for a response from the server, set the amount of time before timeout.	5

Retry (sec.)

Setting	Description	Factory Default
0 to 5	Define the retry interval when trying to reconnect to a server.	1

Server Address 2

Setting	Description	Factory Default
Input the server address	Specify the 2nd server address as the authentication database.	0.0.0.0

UDP Port

Setting	Description	Factory Default
Input the port number	Specify the UDP port.	1812

Share Key

Setting	Description	Factory Default
Input the key	Specify the share key for 2nd server authentication verification.	None

Authentication Type

Setting	Description	Factory Default
PAP	PAP is the authentication type.	CHAP
CHAP	CHAP is the authentication type.	
MS-CHAPv1	MS-CHAPv1 is the authentication type.	

Timeout (sec.)

Setting	Description	Factory Default
5 to 180	When waiting for a response from the server, set the amount of time before the device is timed out.	5

Retry (sec.)

Setting	Description	Factory Default
0 to 5	Set the retry interval when trying to reconnect to a server.	1

When finished, click **APPLY** to save your changes.



NOTE

The RADIUS service will be operated via the 1st server; if it fails, it will run on the 2nd server.

TACACS+

Click **TACACS+** on the menu and then configure the following settings.

TACACS+ Server

Server Address 1 *
0.0.0.0

TCP Port *
49

1 - 65535

Share Key

0 / 64

Auth Type *
CHAP

Timeout *
5

5 - 180 sec.

Retry *
1

0 - 5 times

Server Address 2 *
0.0.0.0

TCP Port *
49

1 - 65535

Share Key

0 / 64

Auth Type *
CHAP

Timeout *
5

5 - 180 sec.

Retry *
1

0 - 5 times

APPLY

Server Address 1

Setting	Description	Factory Default
Input the server address	Specify the 1st server address as the authentication database.	0.0.0.0

TCP Port

Setting	Description	Factory Default
Input the port number	Specify the TCP port.	49

Share Key

Setting	Description	Factory Default
Input the key	Specify the share key for 1st server authentication verification.	None

Authentication Type

Setting	Description	Factory Default
ASCII	ASCII is the authentication type.	CHAP
PAP	PAP is the authentication type.	
CHAP	CHAP is the authentication type.	

Timeout (sec.)

Setting	Description	Factory Default
Input the value	When waiting for a response from the server, set the amount of time before the device is timed out.	5

Retry

Setting	Description	Factory Default
Input the value	Set the retry interval when trying to reconnect to a server.	1

Server Address 2

Setting	Description	Factory Default
Input the server address	Specify the 2nd server address as the authentication database.	0.0.0.0

TCP Port

Setting	Description	Factory Default
Input the port number	Specify the TCP port.	49

Share Key

Setting	Description	Factory Default
Input the key	Specify the share key for 2nd server authentication verification.	None

Authentication Type

Setting	Description	Factory Default
ASCII	ASCII is the authentication type.	CHAP
PAP	PAP is the authentication type.	
CHAP	CHAP is the authentication type.	

Timeout (sec.)

Setting	Description	Factory Default
Input the value	When waiting for a response from the server, set the amount of time before the device is timed out.	5

Retry

Setting	Description	Factory Default
Input the value	Set the retry interval when trying to reconnect to a server.	1

When finished, click **APPLY** to save your changes.



NOTE

The TACACS+ service will be operated via the 1st server; if it fails, it will run on the 2nd server. In addition, users that are created with the TACACS+ server come with Admin privilege.

Diagnostics

This section describes the diagnostics functions of Moxa’s switch. Click **Diagnostics** on the function menu.

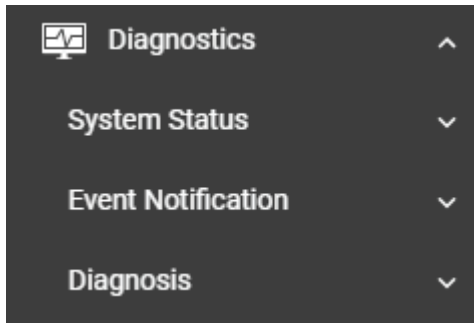

System Status

This section allows users to view the current system status including **Utilization, Statistics, Fiber Check,** and **Module Information.**

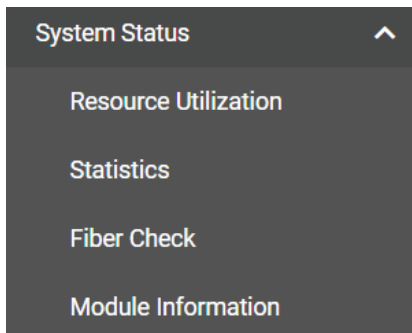

Resource Utilization

Click **Resource Utilization** on the function menu to view the current utilization status including CPU utilization, memory history, power consumption, and power history. All of the information is displayed via graphics, making it easier for users to view the system status. In addition,  icon is available on the upper right corner of each figure, which allows users to view the latest status for each function.

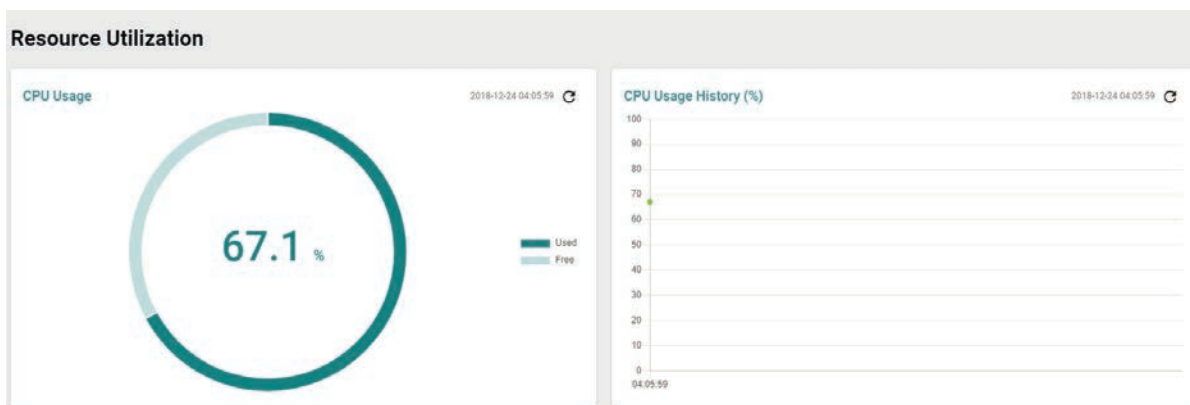

CPU Utilization

Setting	Description	Factory Default
Read-only	Displays the current utilization of the CPU.	None

CPU Usage History

Setting	Description	Factory Default
---------	-------------	-----------------

Read-only	Displays the CPU usage history trend in a chart.	None
-----------	--	------

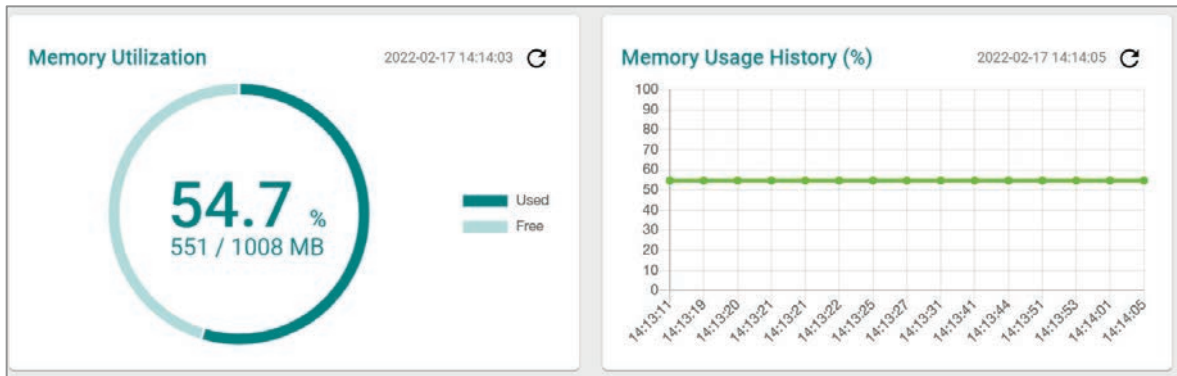

Memory Utilization

Setting	Description	Factory Default
Read-only	Displays the memory status.	None

Memory Usage History

Setting	Description	Factory Default
Read-only	Displays the history of the memory usage.	None

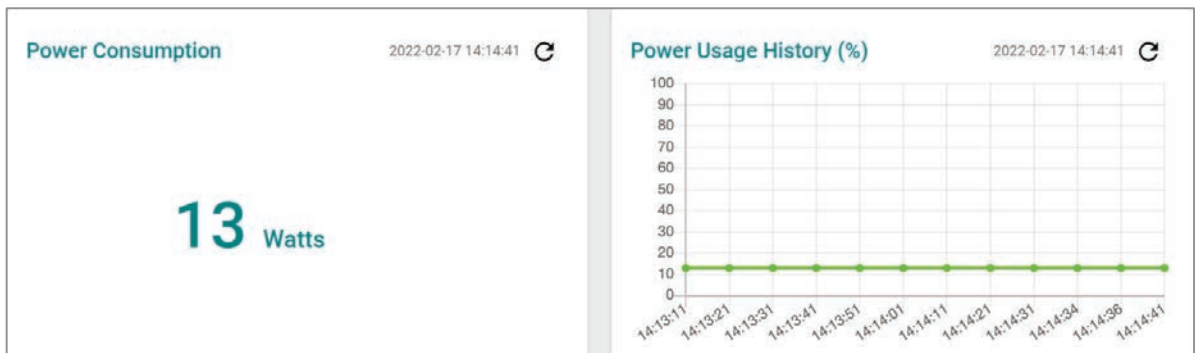

Power Consumption (watt)

Setting	Description	Factory Default
Read-only	Displays the power consumption status.	None

Power Usage History

Setting	Description	Factory Default
Read-only	Displays the history of the power usage.	None



NOTE



The **Power Consumption** and **Power Usage History** widgets are not supported by the RKS-G4000 Series and will not show any data.

Statistics

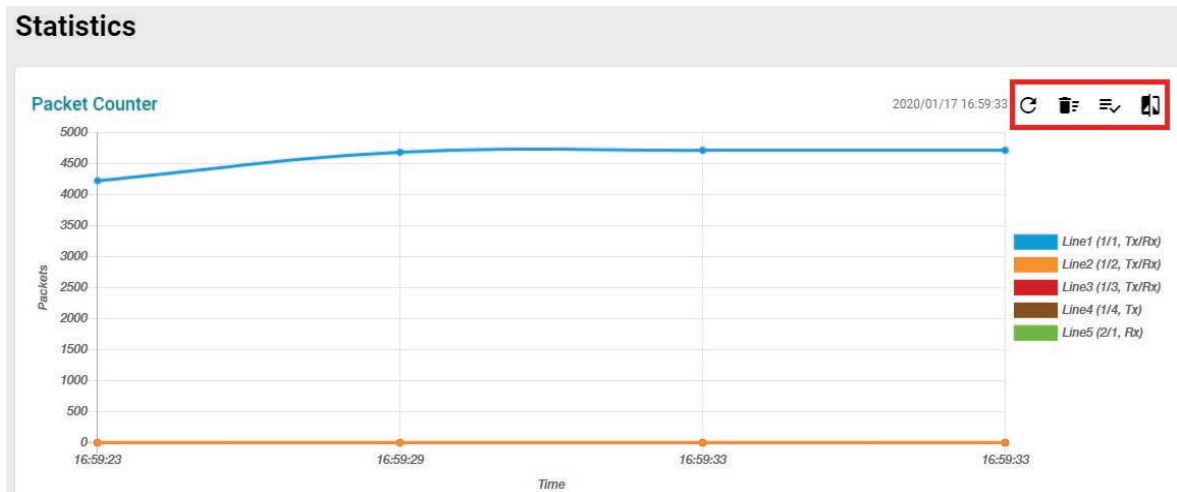



Click **Statistics** on the function menu. The first figure shows the packet counter status.



The status of the different ports will be shown in different colors. A maximum of five ports will have their information displayed.

	Line1 (1/1, Tx/Rx)
	Line2 (1/2, Tx/Rx)
	Line3 (1/3, Tx/Rx)
	Line4 (1/4, Tx)
	Line5 (2/1, Rx)

There are four icons on the right upper corner of the page. The table below provides a description for each one.

Item	Name	Description
	Refresh	All statistical data will be refreshed.
	Reset Statistics Graph	The packet counter will be cleared and the graphs will be reset.
	Display Setting	All selected setting items will be shown here.
	Data Comparison	Select the data you want to compare.

Refreshing the Statistics

Click the **Refresh** icon and all statistical data will be refreshed immediately.

Resetting Statistics Graph

Click the **Reset** icon and select **CLEAR** to clear the packet counter and reset the graph.

Reset Statistics Graph

Are you sure to clear all graph data?

CANCEL
CLEAR

Display Setting

Click the **Display Setting** icon and all settings will be displayed. You can select the display mode from the drop-down list.

Display Settings

Display Mode *
Packet Counter

Line 1 Monitoring Port *
1/1

Line 1 Sniffer *
Tx/Rx

Line 2 Monitoring Port *
1/2

Line 2 Sniffer *
Tx/Rx

Line 3 Monitoring Port *
1/3

Line 3 Sniffer *
Tx/Rx

Line 4 Monitoring Port *
1/4

Line 4 Sniffer *
Tx

Line 5 Monitoring Port *
2/1

Line 5 Sniffer *
Rx

CANCEL APPLY

The Monitoring Port is the port you want to view or monitor. The sniffer port is the port that you can choose to view its receiving or transmission status or both.

Display Mode

Setting	Description	Factory Default
Packet Counter	The packet statistics will be displayed.	Packet Counter
Bandwidth Utilization	The bandwidth statistics will be displayed.	

Click **APPLY** to complete.

Comparing Data

Click the **Data Comparison** icon and then select the items from the relevant fields.

Data Comparison

Benchmark Line *
Benchmark Line - Time *

Comparison Line *
Comparison Line - Time *

CLOSE

Click **CLOSE** to complete.

The data comparison figure will be shown. Click **CLOSE** to finish.

Data Comparison

Benchmark Line *	Benchmark Line - Time *
1/1, Tx/Rx	14:15:18
<hr/>	
Comparison Line *	Comparison Line - Time *
1/2, Tx/Rx	14:15:18

Tx Total Octets	0	↕	▼
Tx Total Packets	0	↕	▼
Tx Unicast Packets	0	↕	▼
Tx Multicast Packets	0	↕	▼
Tx Broadcast Packets	0	↕	▼

[CLOSE](#)

The detailed packet transmission activity for each port can be seen in the table below.

🔍 🔧 🗑️ 🔄

Port	Tx Total Octets	Tx Total Packets	Tx Unicast Packets	Tx Multicast Packets	Tx Broadcast Packets	Rx Total Octets	Rx Total Packets	Rx Unicast Packets	Rx Multicast Packets
1/1	10877827	7891	7826	64	1	649940	5501	3706	1482
1/2	0	0	0	0	0	0	0	0	0
1/3	0	0	0	0	0	0	0	0	0
1/4	0	0	0	0	0	0	0	0	0

Collision Packets	Late Collision Packets	Excessive Collision Packets	CRC Align Error Packets	Drop Packets	Undersize	Oversize Packets	Fragment Packets	Jabber Packets
0	0	0	0	0	0	0	0	0
0	0	0	0	0	0	0	0	0
0	0	0	0	0	0	0	0	0
0	0	0	0	0	0	0	0	0

Port: port number

Tx Total Octets: Number of octets transmitted including bad packets and FCS octets. Framing bits are not included.

Tx Total Packets: Number of packets transmitted.

Tx Unicast Packets: Number of Unicast packets transmitted.

Tx Broadcast Packets: Number of good Broadcast packets transmitted. Multicast packets are not included.

Rx Total Octets: Number of octets received, including bad packets and FCS octets. Framing bits are not included.

Rx Unicast Packets: Number of Unicast packets received.

Rx Multicast Packets: Number of Multicast packets received.

Rx Broadcast Packets: Number of good Broadcast packets received. Multicast packets are not included.

Rx Pause Packets: Number of pause packets received.

Collision Packets: Number of collisions received. If Jumbo Frames are enabled, the threshold of Jabber Frames is raised to the maximum size of Jumbo Frames.

Late Collision Packets: Number of late collision packets.

Excessive Collision Packets: Number of excessive collision packets.

CRC Align Error Packets: Number of CRC and Align errors that have occurred.

Drop Packets: Number of packets that were dropped.

Undersize: Number of undersized packets (less than 64 octets) received.

Oversize Packets: Number of oversized packets (over 1518 octets) received.

Fragment Packets: Number of fragments (packets with less than 64 octets, excluding framing bits, but including FCS octets) received.

Jabber Packets: Number of received packets that were longer than 1632 octets. This number excludes frame bits, but includes FCS octets that had either a bad FCS (Frame Check Sequence) with an integral number of octets (FCS Error) or a bad FCS with a non-integral octet (Alignment Error) number.

Fiber Check

Overview

Optical fiber is commonly used for long-distance data transmission, so it is very costly to troubleshoot fiber cables and fiber transceivers at remote sites when issues occur. Moxa industrial Ethernet switches provide Fiber Check features to support the link status of fiber connectors diagnosis, including Moxa's SFP and fixed type (multi-mode SC/ST and single-mode SC) connectors by displaying the optical parameters and corresponding threshold. This makes it easier for the user to determine if the modules are working properly and receive a notification when the threshold has been exceeded from the central site.

This feature can greatly facilitate the troubleshooting process for optical fiber links and reduce costs for onsite debugging.

How Does Fiber Check Work?

The feature is only designed for Moxa's SFP and fixed type (multi-mode SC/ST and single-mode SC).

The feature displays the fiber module's running status and the corresponding threshold. The running status includes wavelength, temperature, voltage, Tx power, and Rx power. Furthermore, it also lists out the corresponding upper/lower bound threshold of temperature, voltage, Tx power, and Rx power for the module. Users can decide to adopt fiber module's default threshold under "Auto" mode or define the threshold by themselves under "User Define" mode, and enable the Trap, email warning, and/or relay warning functions to receive an alarm or relay if the specified fiber ports exceed the corresponding threshold.

Click **Fiber Check** on the function menu and select the **Status** tab to view the current fiber port information of the switch. You may switch the temperature unit from Celsius to Fahrenheit by clicking the icon on the upper right corner of the page.

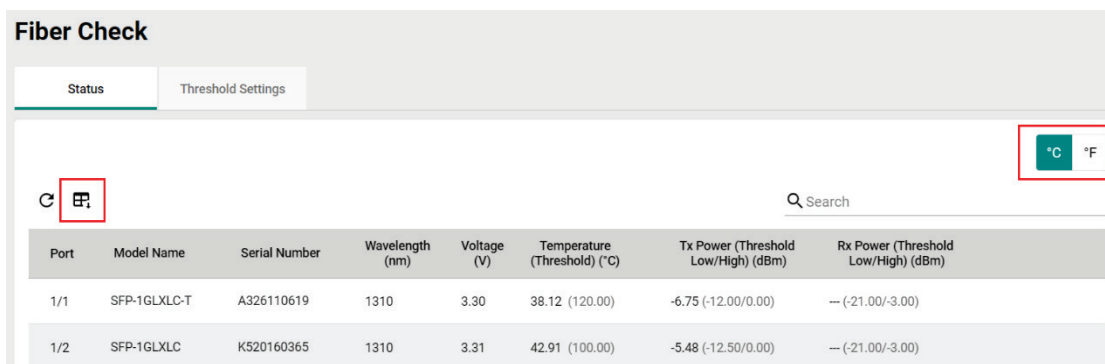

The screenshot shows the 'Fiber Check' web interface. At the top, there are two tabs: 'Status' (selected) and 'Threshold Settings'. On the right side, there is a temperature unit selector with icons for Celsius (°C) and Fahrenheit (°F). Below this is a search bar with a magnifying glass icon and the text 'Search'. The main content is a table with the following columns: Port, Model Name, Serial Number, Wavelength (nm), Voltage (V), Temperature (Threshold) (°C), Tx Power (Threshold Low/High) (dBm), and Rx Power (Threshold Low/High) (dBm). The table contains two rows of data.

Port	Model Name	Serial Number	Wavelength (nm)	Voltage (V)	Temperature (Threshold) (°C)	Tx Power (Threshold Low/High) (dBm)	Rx Power (Threshold Low/High) (dBm)
1/1	SFP-1GLXLC-T	A326110619	1310	3.30	38.12 (120.00)	-6.75 (-12.00/0.00)	-- (-21.00/-3.00)
1/2	SFP-1GLXLC	K520160365	1310	3.31	42.91 (100.00)	-5.48 (-12.50/0.00)	-- (-21.00/-3.00)

Refer to the following table for the description of each parameter.

Parameter	Description
Port	Switch port number with a fiber connection.
Model Name	Moxa SFP/fixed type fiber model name.
Serial Number	Moxa SFP/fixed type fiber serial number.
Wavelength(nm)	Wavelength of the fiber connection.
Voltage (V)	Voltage supply to the fiber connection.
Temperature (Threshold)(°C)	Fiber connection current temperature. (Fiber connection Max. temperature threshold.)
Tx power (Threshold Low/High) (dBm)	The current amount of light being transmitted into the fiber optic cable. (The Min./Max. of threshold of light being transmitted into the fiber optic cable.)
Rx power (Threshold Low/High)(dBm)	The current amount of light being received from the fiber optic cable. (The Min./Max. threshold of light being received from the fiber optic cable.)





Select **Threshold Settings** to configure the threshold settings. Click the  icon to configure. You may switch the temperature unit from Celsius to Fahrenheit by clicking the icon on the upper right corner of the page.

Fiber Check

Status Threshold Settings

°C °F

Search

	Port	Mode	Temperature Threshold (°C)	Tx Power Threshold Low (dBm)	Tx Power Threshold High (dBm)	Rx Power Threshold Low (dBm)	Rx Power Threshold High (dBm)
	1/1	Auto	--	--	--	--	--
	1/2	Auto	--	--	--	--	--
	1/3	Auto	--	--	--	--	--
	1/4	Auto	--	--	--	--	--

Edit Port 1/1 Settings

Mode *

Auto

Copy configurations to ports

CANCEL APPLY

Mode

Setting	Description	Factory Default
Auto	Select this mode to use the default fiber module's threshold specification. Please refer to "Fiber Check Threshold Values for Auto Mode"	Auto
User Defined	Users can define the fiber module's threshold.	

Fiber Check Threshold Values for Auto Mode

Model Name	Temperature Threshold (°C)	Tx Power (Max./Min.) (dBm)	Rx Power (Max./Min.) (dBm)
FEMST	120	-11/-23	-3/-32.0
FEMSC	120	-11/-23	-3/-32.0
FESSC	120	3.0/-8.0	-3/-34.0
SFP-1FEMLC-T	120	-5.0/-21.0	-3/-32.0
SFP-1FESLC-T	120	3.0/-8.0	-3/-34.0
SFP-1FELLC-T	120	3.0/-8.0	-3/-34.0
SFP-1GSXLC-T	110	-1.0/-12.5	0/-18.0
SFP-1GLSXLC-T	120	2.0/-12.0	-1/-19.0
SFP-1GLXLC-T	120	0.0/-12.0	-3.0/-21.0
SFP-1GLHLC-T	120	0.0/-11.0	-3/-23.0
SFP-1GLHXLC-T	120	6.0/-7.0	-1.0/-24.0
SFP-1GZXLC-T	120	8.0/-3.0	-1/-24.0
SFP-1G10ALC-T	120	0.0/-12.0	-3/-21.0
SFP-1G10BLC-T	120	0.0/-12.0	-3.0/-21.0
SFP-1G20ALC-T	120	1.0/-11.0	-2/-23.0
SFP-1G20BLC-T	120	1.0/-11.0	-2.0/-23.0
SFP-1G40ALC-T	120	5.0/-6.0	-1.0/-23.0
SFP-1G40BLC-T	120	5.0/-6.0	-1.0/-23.0
SFP-1GSXLC	100	-1.0/-12.5	0/-18.0
SFP-1GLSXLC	100	2.0/-12.0	-1/-19.0
SFP-1GLXLC	100	0.0/-12.5	-3/-21.0
SFP-1GLHLC	100	0.0/-11.0	-3/-23.0
SFP-1GLHXLC	100	6.0/-7.0	-1.0/-24.0
SFP-1GZXLC	100	8.0/-3.0	-1/-24.0
SFP-1GEZXLC	100	8.0/-3.0	-9.0/-30.0
SFP-1GEZXLC-120	100	6.0/-5.0	-8/-33.0
SFP-1G10ALC	100	0.0/-12.0	-2/-21.0
SFP-1G10BLC	100	0.0/-12.0	-3.0/-21.0
SFP-1G20ALC	100	1.0/-11.0	-2/-23.0
SFP-1G20BLC	100	1.0/-11.0	-2.0/-23.0
SFP-1G40ALC	100	5.0/-6.0	-1.0/-23.0
SFP-1G40BLC	100	5.0/-6.0	-1.0/-23.0
SFP-2.5GMLC-T	120	2.0/-10.5	0.0/-13.5
SFP-2.5GSLC-T	120	0.0/-12.0	3.0/-15.0
SFP-2.5GLSLC-T	120	3.0/-8.0	0.0/-16.0
SFP-2.5GSLHLC-T	120	4.0/-7.0	1.0/-19.0
SFP-10GERLC-T	110	5.0/-4.0	-1/NA*
SFP-10GZRLC-T	100	7.0/-3.0	-7/NA*
SFP-10GLRLC-T	120	3.5/-11.2	0.5/NA*
SFP-10GSRLC-T	110	2.0/-8.0	0.5/NA*

*NA for RX Power means the specification is not provided in the datasheet for the fiber module. In Auto Mode, -40 is the minimum Rx Power threshold, as defined in SFF-8472.

To define the fiber check threshold, configure the following settings.

Edit Port 1/1 Settings

Mode
User Defined

Temperature Threshold *
128 °C °F

-128 - 128 °C

Tx Power Threshold Low *
-40
-40 - 8.2 dBm

Rx Power Threshold Low *
-40
-40 - 8.2 dBm

Tx Power Threshold High *
8.2
-40 - 8.2 dBm

Rx Power Threshold High *
8.2
-40 - 8.2 dBm

Copy configurations to ports i

CANCEL
APPLY

Temperature Threshold

Setting	Description	Factory Default
Temperature for threshold	Specify the temperature threshold in either Celsius or Fahrenheit.	128°C

Tx Power Threshold Low

Setting	Description	Factory Default
-40 to 8.2 dBm	Specify the lowest threshold for Tx power.	-40

Tx Power Threshold High

Setting	Description	Factory Default
-40 to 8.2 dBm	Specify the highest threshold for Tx power.	8.2

Rx Power Threshold Low

Setting	Description	Factory Default
-40 to 8.2 dBm	Specify the lowest threshold for Rx power.	-40

Rx Power Threshold High

Setting	Description	Factory Default
-40 to 8.2 dBm	Specify the highest threshold for Rx power.	8.2

Copy Configurations to Ports

Setting	Description	Factory Default
Select the port(s) from the drop-down list	Select the port(s) you want to copy the same configurations to.	None

When finished, click **APPLY** to save your changes.

The **Status** tab displays the running information of current data and the threshold of the fiber module. Users can select to display temperature by **Fahrenheit** or **Celsius**. The following steps allow users to configure the threshold parameters:

1. Click **Threshold Setting** to **Edit** or **Reset** the mode and the threshold value to default.
2. Select mode for the threshold definition for the specified port(s). The threshold will be displayed in the **Status** tab and function as the baseline for users to receive notifications if the running status exceeds the threshold value when users enable the notification of Fiber Check Warning in Event Notification.
 - **Auto** mode: This is the default mode. Users can stay in this mode to adopt default fiber module's threshold specification. Please refer to "**Fiber Check Threshold Values for Auto mode**" for the value.
 - **User Defined** mode: Users can define the threshold values of temperature, Tx power lower/upper bound, and Rx power lower/upper bound.
3. Copy the configurations to the assigned ports by selecting port(s) in the **Copy configurations to ports** field. These configurations are for the fiber module only, so they cannot be copied to copper ports. Click **APPLY** to save the changes.
4. If users want to receive notifications when the running status exceeds the threshold for specified port(s), please go to the **Event Notifications** page and switch to the Port tab. Edit **Fiber Check Warning** to **Enable Trap**, **Email** warning, and/or **Relay** warning for the registered ports. Click **APPLY** to save the changes.

Module Information

Click **Module Information** on the function menu to view the current module information of the switch.

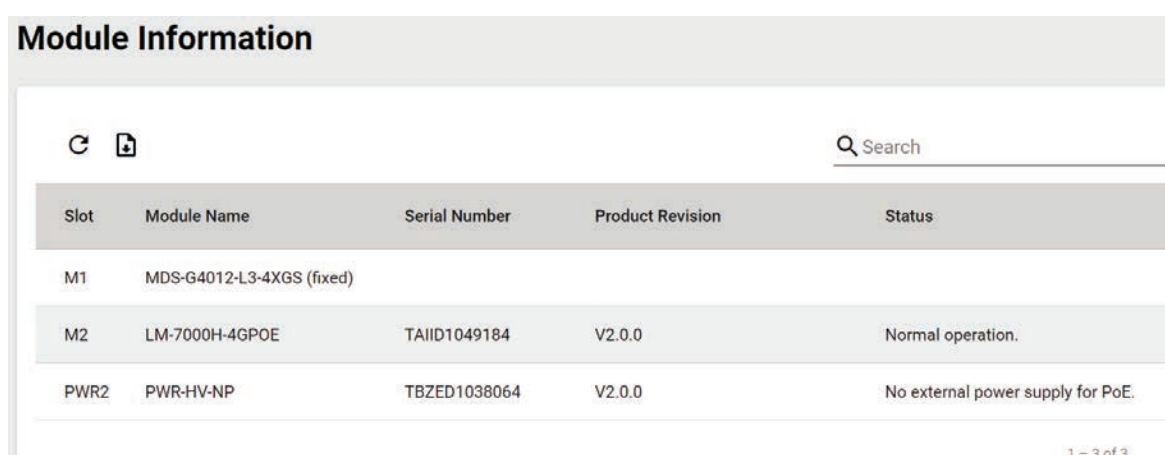

The screenshot shows the 'Module Information' page with a table listing installed modules. The table has columns for Slot, Module Name, Serial Number, Product Revision, and Status. There are three rows of data. The first row shows Slot M1 with Module Name MDS-G4012-L3-4XGS (fixed). The second row shows Slot M2 with Module Name LM-7000H-4GPOE, Serial Number TAIID1049184, Product Revision V2.0.0, and Status Normal operation. The third row shows Slot PWR2 with Module Name PWR-HV-NP, Serial Number TBZED1038064, Product Revision V2.0.0, and Status No external power supply for PoE. There are also icons for refresh and download at the top left, and a search bar at the top right. The page number '1 - 3 of 3' is visible at the bottom right.

Slot	Module Name	Serial Number	Product Revision	Status
M1	MDS-G4012-L3-4XGS (fixed)			
M2	LM-7000H-4GPOE	TAIID1049184	V2.0.0	Normal operation.
PWR2	PWR-HV-NP	TBZED1038064	V2.0.0	No external power supply for PoE.

For example, in the figure above, the MDS-G4012-L3 switch is installed in Slot M1 and there is an LM-7000H-4GPOE module installed in Slot M2. In addition, a power module has been installed in Slot PWR2.



ATTENTION

When a different type of module has been inserted into the switch, we suggest you re-configure the settings, or use reset to default settings. When the same module is inserted into the slot, users do not need to re-configure the settings or use reset to default settings.

Log & Event Notification

This section includes the information for **Event Log**, **Event Notification**, **Syslog**, **SNMP Trap/Inform**, **Email Settings**, and **Relay Alarm Cut-off**.

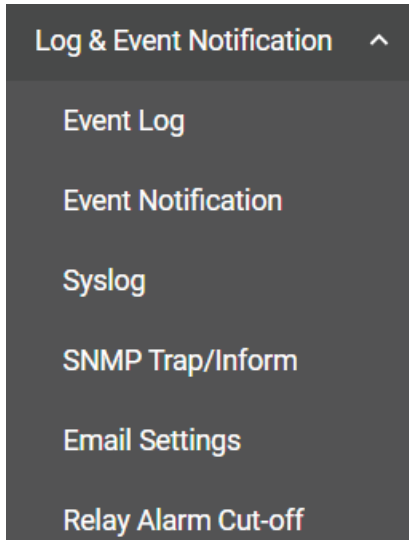



Event Log

To check event logs, click the **Event Log** tab.

Event Log

Event Log Oversize-Action Backup

   🔍 Search

Index	Bootup Number	Severity	Timestamp	Uptime	Message
1	21	Notice	2018-12-21 19:15:28	0d0h22m2s	Configuration [Web] changed by admin.
2	21	Notice	2018-12-21 19:15:13	0d0h21m47s	Configuration [Web] changed by admin.
3	21	Notice	2018-12-21 18:55:50	0d0h2m24s	[Account:admin] successfully logged in via local.
4	21	Critical	2018-12-21 18:54:18	0d0h0m52s	System has performed a cold start.
5	21	Notice	2018-12-21 18:54:01	0d0h0m35s	Interface vlan1 up.
6	21	Notice	2018-12-21 18:54:01	0d0h0m35s	Port 2/1 link up.
7	21	Warning	2018-12-21 18:53:57	0d0h0m31s	The PTP sync status has changed from DISABLED to FREERUN.
8	20	Notice	2018-12-21 21:23:34	0d2h30m8s	Interface vlan1 down.

Editing Oversize Action

To edit the event log oversize-action, click the **Oversize-Action** tab.

Configure the following settings when the event log file is full.

Oversize-Action

Setting	Description	Factory Default
Overwrite the oldest event log	Overwrite the oldest event log.	Overwrite the oldest event log
Stop recording event log	Stop recording event logs.	

Capacity Warning

Setting	Description	Factory Default
Enabled	Enable capacity warning event log.	Disabled
Disabled	Disable capacity warning event log.	

Warning Threshold (%)

Setting	Description	Factory Default
50 to 100	Set the warning threshold as a percentage.	80

Click **APPLY** to save your changes.

Backing Up Event Logs

Click the **Backup** tab first.

There are four ways to back up your event log files: from a local location of your computer, by remote SFTP server, by remote TFTP server, or by a USB tool.

Local

Select **Local** from the drop-down list under **Method**. Click **BACKUP**, which will save the event log files to your local computer.

TFTP Server

Select **TFTP** from the drop-down list under **Method**.

The screenshot shows the 'Event Log' configuration page with the 'Backup' tab selected. The 'Method' dropdown menu is set to 'TFTP'. Below it, there are two input fields: 'Server IP Address *' and 'File Name *'. A green 'BACKUP' button is located at the bottom left of the form.

Server IP Address

Setting	Description	Factory Default
Input the IP address of the TFTP server	Users can input the IP address of the TFTP server.	None

File Name

Setting	Description	Factory Default
Input the backup file name (supports up to 54 characters, including the .ini file extension).	Users can input the file name to back up the event log files.	None

When finished, click **BACKUP** to back up the event log files.

SFTP Server

Select **SFTP** from the drop-down list of **Method**.

The screenshot shows the 'Event Log' configuration page with the 'Backup' tab selected. The 'Method' dropdown menu is set to 'SFTP'. Below it, there are four input fields: 'Server IP Address *', 'File Name *', 'Account *', and 'Password *'. A green 'BACKUP' button is located at the bottom left of the form.

Server IP Address

Setting	Description	Factory Default
Input the IP address of the SFTP server	Input the IP address of the SFTP server where the event log files will be saved.	None

File Name

Setting	Description	Factory Default
Input the backup file name (support up to 54 characters, including the .ini file extension).	Input the file name of the event log files	None

Account

Setting	Description	Factory Default
Input the account of the SFTP server	An account must be provided to authorize the SFTP server for secure connection.	None

Password

Setting	Description	Factory Default
Input the passwords for the SFTP server	The password has to be specified in order to authorize the SFTP Server for secure connection.	None

When finished, click **BACKUP** to back up the event log files.

External Storage

Select **USB** or **microSD** from the drop-down list under **Method**.

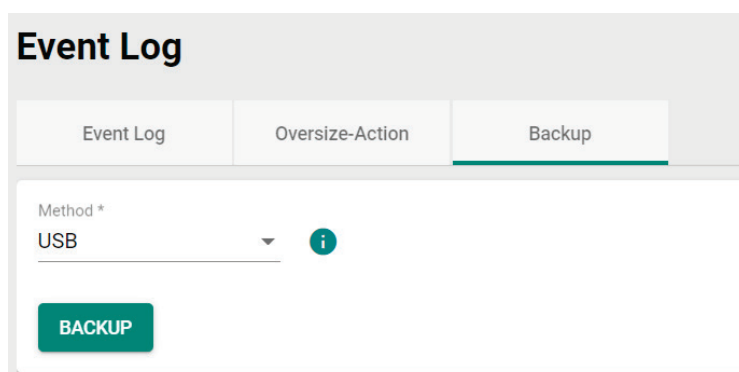

The screenshot shows the 'Event Log' configuration page. At the top, there are three tabs: 'Event Log', 'Oversize-Action', and 'Backup', with 'Backup' selected. Below the tabs, there is a 'Method *' dropdown menu currently set to 'USB'. To the right of the dropdown is an information icon. Below the dropdown is a green 'BACKUP' button.

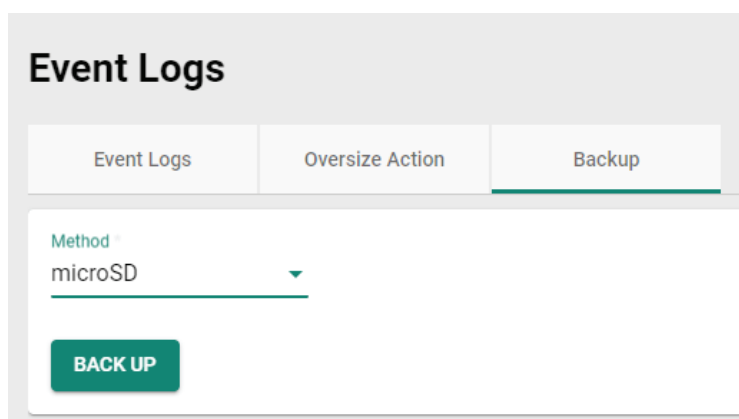

The screenshot shows the 'Event Logs' configuration page. At the top, there are three tabs: 'Event Logs', 'Oversize Action', and 'Backup', with 'Backup' selected. Below the tabs, there is a 'Method *' dropdown menu currently set to 'microSD'. Below the dropdown is a green 'BACK UP' button.

Depending on the selected method, insert a Moxa ABC-02 USB-based or ABC-03 microSD-based configuration tool into the USB port or microSD slot of the switch and click **BACK UP** to back up the event log files.



Note

If you have difficulty using the ABC-02 configuration tool, check if **USB Function** has been enabled in **Hardware Interface** section.

Auto Backup of Event Logs

To enable automatic backup, select **Enabled** from the drop-down list. Click **APPLY** to back up the event log files automatically.









NOTE

If **Auto Backup of Event Logs** is enabled and both the ABC-02 USB-based and ABC-03 microSD-based configuration backup tools are inserted, the switch will only back up the event logs to the ABC-02 USB tool.

Event Notification

There are two functions within Event Notification: **System and Function**, and **Port**.

In the **Event Notification** menu, click the **System and Function** tab, and then click the  icon on the specific event you want to configure. For example, select  icon for warm start when the switch reboots.

Event Notification					
System and Function		Port			
Group	Event Name	Enabled	Severity	Registered Action	
	General	Warm start	Enabled	Notice	Trap, Email
	General	Password changed	Enabled	Notice	Trap, Email
	General	Login success	Enabled	Notice	Trap, Email
	General	Configuration changed	Enabled	Notice	Trap, Email
	General	Configuration imported	Enabled	Notice	Trap, Email

Configure the following settings.

Edit This Event Notification

Event Name
Warm start

Enabled *
Enabled

Registered Action
Trap, Email

CANCEL APPLY

Enabled

Setting	Description	Factory Default
Enabled	Enable Event Notification for this event.	Enabled
Disabled	Disable Event Notification for this event.	

Registered Action

For the MDS-G4000 and MDS-G4000-4XGS Series:

Setting	Description	Factory Default
Trap	Send an SNMP Trap for event notifications.	Trap/Email
Email	Send an email for event notifications.	
MGMT Relay	Trigger the MGMT Relay for event notifications.	
PWR1 Relay	Trigger the PWR1 Relay for event notifications.	
PWR2 Relay	Trigger the PWR2 Relay for event notifications.	

For the RKS-G4000 and EDS-(G)4000 Series:

Setting	Description	Factory Default
Trap	Send an SNMP Trap for event notifications.	Trap/Email
Email	Send an email for event notifications.	
Relay	Trigger the Relay for event notifications.	

When finished, click **APPLY** to save your changes.







In addition, use the same method to edit other events, such as login lockout, warm start, password changed, etc.

Next, in the **Event Notification** menu, click the **Port** tab, and then click the  icon on the specific port status on Event Name. For example, select the  icon for event notifications when the port status is on.

Event Notifications

System and Functions **Port**

Search

Event Name	Enable	Severity	Registered Action	Registered Port
 Port On	Enabled	Notice	Trap, Email	1/1, 1/2, 1/3, 1/4, 2/1, 2/2, 2/3, 2/4, 2/5, 2/6, 2/7, 2/8, 3/1, 3/2, 3/3, 3/4, 3/5, 3/6, 3/7, 3/8, 4/1, 4/2, 4/3, 4/4, 4/5, 4/6, 4/7, 4/8
 Port Off	Enabled	Notice	Trap, Email	1/1, 1/2, 1/3, 1/4, 2/1, 2/2, 2/3, 2/4, 2/5, 2/6, 2/7, 2/8, 3/1, 3/2, 3/3, 3/4, 3/5, 3/6, 3/7, 3/8, 4/1, 4/2, 4/3, 4/4, 4/5, 4/6, 4/7, 4/8
 Port shut down by Port Security	Enabled	Warning	Trap, Email	1/1, 1/2, 1/3, 1/4, 2/1, 2/2, 2/3, 2/4, 2/5, 2/6, 2/7, 2/8, 3/1, 3/2, 3/3, 3/4, 3/5, 3/6, 3/7, 3/8, 4/1, 4/2, 4/3, 4/4, 4/5, 4/6, 4/7, 4/8
 Port shut down by Rate Limit	Enabled	Warning	Trap, Email	1/1, 1/2, 1/3, 1/4, 2/1, 2/2, 2/3, 2/4, 2/5, 2/6, 2/7, 2/8, 3/1, 3/2, 3/3, 3/4, 3/5, 3/6, 3/7, 3/8, 4/1, 4/2, 4/3, 4/4, 4/5, 4/6, 4/7, 4/8
 Port recovered by Rate Limit	Enabled	Warning	Trap, Email	1/1, 1/2, 1/3, 1/4, 2/1, 2/2, 2/3, 2/4, 2/5, 2/6, 2/7, 2/8, 3/1, 3/2, 3/3, 3/4, 3/5, 3/6, 3/7, 3/8, 4/1, 4/2, 4/3, 4/4, 4/5, 4/6, 4/7, 4/8
 Fiber Check Warning	Enabled	Warning	Trap, Email	1/1, 1/2, 1/3, 1/4, 2/1, 2/2, 2/3, 2/4, 2/5, 2/6, 2/7, 2/8, 3/1, 3/2, 3/3, 3/4, 3/5, 3/6, 3/7, 3/8, 4/1, 4/2, 4/3, 4/4, 4/5, 4/6, 4/7, 4/8

1 - 6 of 6

Configure the following settings.

Edit Event Notification

Event Name
Port On

Enabled *
Enabled

Registered Action
Trap, Email

Registered Port
All Ports

CANCEL APPLY

Event Name

Setting	Description	Factory Default
Event name	Show the event name of the port. (read only)	Event name of each port

Enabled

Setting	Description	Factory Default
Enabled	Enable Event Notification for this event.	Enabled
Disabled	Disable Event Notification for this event.	

Registered Action

Setting	Description	Factory Default
Trap	Send SNMP Trap for event notifications.	Trap/Email

Email	Send an email for event notifications.	
MGMT Relay	Trigger MGMT Relay for event notifications.	
PWR1 Relay	Trigger PWR1 Relay for event notifications.	
PWR2 Relay	Trigger PWR2 Relay for event notifications.	

Registered Port

Setting	Description	Factory Default
Select port(s) from the drop-down list	Specify the port(s) that use the registered action.	All Ports

When finished, click **APPLY** to save your changes.

In addition, use the same method to edit other events such as, port status is off, port shutdown by port security, and port recovery by rate limit, etc.

Check the following table for the severity degree of each event.

Event Name	Severity
802.1X Auth Failed	Warning
ABC-02 is inserted or unplugged	Notice
ABC-03 is inserted or unplugged	Notice
Account log out	Notice
Account removed	Notice
Account settings changed	Notice
Announce message with different interval	Warning
Announce timeout	Warning
Check if hardware revision is valid	Notice
Check if it is a known power module	Warning
Cold start	Critical
Configuration changed	Notice
Configuration exported	Notice
Configuration imported	Notice
Coupling changed	Warning
dhcpsnp untrust mac discards	Warning
dhcpsnp untrust server discards	Warning
DHCP client ingress discards packets due to the DHCP Snooping rule	Warning
DHCP server discards packets due to the DHCP Snooping rule	Warning
DI off	Notice
DI on	Notice
Dual homing path changed	Warning
Event log export	Notice
Firmware upgrade failed	Warning
Firmware upgrade successful	Notice
Grand Master changed	Warning
Hardware revision is not allowed	Error
Interface link down	Notice
Interface link up	Notice
LLDP table changed	Info
Log capacity threshold	Warning
Log Turbo Chain Port Restart	Notice
Login failed	Warning
Login lockout	Warning
Login success	Notice
Low input voltage	Warning
Master changed	Warning
Master mismatch	Warning
module change	Notice
Module Initialized Fail	Error
Module inserted	Notice
Module removed	Notice
MSTP new port role	Warning
MSTP root changed	Warning

Event Name	Severity
MSTP topology changed	Warning
Non-PD or PD short circuit	Warning
OSPF DR router adjacency changed	Notice
OSPF interface DR changed	Notice
OSPF interface ISM became DR	Notice
Over power budget limit	Warning
Packet dropped by Port Security	Warning
Password changed	Notice
PD no response	Error
PD over-current	Error
PD power off	Notice
PD power on	Notice
Port off	Notice
Port on	Notice
Port recovery by Rate Limit	Warning
Port shutdown by Loop	Critical
Port shutdown by Port Security	Warning
Port shutdown by Rate Limit	Warning
Port state change	Info
Power detection failure	Warning
Power module inserted	Notice
Power module removed	Notice
Power Off->On	Notice
Power On->Off	Notice
PTP message with the wrong domain number	Warning
Redundant port health check failed	Error
Relay Override message	Notice
Relay Triggered message	Notice
RMON failing alarm	Warning
RMON raising alarm	Warning
RSTP invalid BPDU	Warning
RSTP migration	Warning
RSTP new port role	Warning
RSTP root changed	Warning
RSTP topology changed	Warning
Send message failed	Warning
SSH Key generated	Notice
SSL certification changed	Notice
Sync status changed	Warning
Topology changed	Warning
Topology changed (RSTP)	Warning
Topology changed (Turbo Chain)	Warning
Topology changed (Turbo Ring)	Warning
Topology changed (MSTP)	Warning
Unknown module	Warning
VRRP Master changed	Warning
Warm start	Notice
When the trust host moves, it will send a log to Moxa log handler.	Warning



NOTE

To ensure users are correctly notified about events, the relay alarm will not be automatically cut off once triggered. Please refer to the **Relay Output Settings and Status** section on how to cut off the relay alarm.

Syslog

General Settings

Click **Syslog** on the function menu and configure the following settings.

Syslog

- General
- Authentication

Syslog *
Disabled

Syslog Server 1 * Authentication *
Disabled Disabled

Address 1 UDP Port
514
1 - 65535

Syslog Server 2 * Authentication *
Disabled Disabled

Address 2 UDP Port
514
1 - 65535

Syslog Server 3 * Authentication *
Disabled Disabled

Address 3 UDP Port
514
1 - 65535

APPLY

Syslog

Setting	Description	Factory Default
Enabled	Enable logging to a syslog server.	Disabled
Disabled	Disable logging to a syslog server.	

Syslog Server 1

Setting	Description	Factory Default
Enabled	Enable the 1st log server.	Disabled
Disabled	Disable the 1st log server.	

Address 1

Setting	Description	Factory Default
IP Address	Input the IP address of the Syslog 1st server that is used by your network.	None

UDP Port

Setting	Description	Factory Default
1 to 65535	Input the UDP port number.	514

Syslog Server 2

Setting	Description	Factory Default
Enabled	Enable the 2nd syslog server.	Disabled
Disabled	Disable the 2nd syslog server.	

Address 2

Setting	Description	Factory Default
IP Address	Input the IP address of Syslog 2nd server that is used by your network.	None

UDP Port

Setting	Description	Factory Default
1 to 65535	Input the UDP port number.	514

Syslog Server 3

Setting	Description	Factory Default
Enabled	Enable the 3rd syslog server.	Disabled
Disabled	Disable the 3rd syslog server.	

Address 3

Setting	Description	Factory Default
IP Address	Input the IP address of the Syslog 3rd server that is used by your network.	None

UDP Port

Setting	Description	Factory Default
1 to 65535	Input the UDP port number.	514

When finished, click **APPLY** to save your changes.



NOTE

If the syslog server cannot receive the previous logs, it is possible that the receiving port of the syslog server is not ready. We suggest you enable the Linkup Delay function to delay the log delivery time.

Click **Authentication** tab and the  icon the function menu.

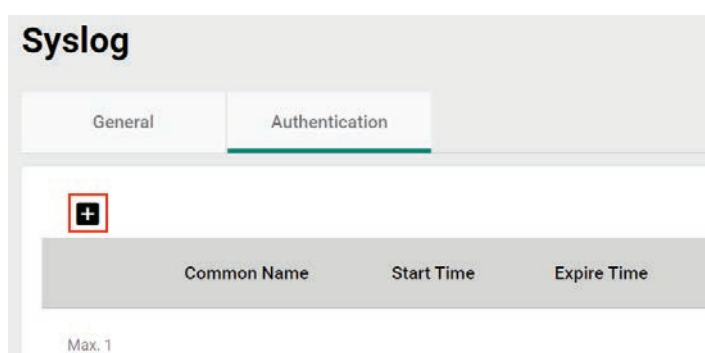

Configure the following settings.

Client Certificate

Setting	Description	Factory Default
Click the  icon and select the file from your computer.	Import the client certificate file.	None

Client Key

Setting	Description	Factory Default
Click the  icon and select the file from your computer.	Import the client key file.	None

CA Key

Setting	Description	Factory Default
Click the  icon and select the file from your computer.	Import the CA certificate file.	None

When finished, click **CREATE** to save your changes.

SNMP Trap/Inform

SNMP Trap Host Settings

SNMP Trap allows an SNMP agent to notify the NMS of a significant event. The switch supports two SNMP modes: **Trap** mode and **Inform** mode. Click **SNMP Trap/Inform** on the menu, and then select  icon on the page.

Configure the following settings.

Create Host Settings

Recipient IP/Name *

0 / 32

Mode *

Trap Community *

At least 4 characters 0 / 32

CANCEL
CREATE

Recipient IP/Name

Setting	Description	Factory Default
Input a recipient IP or name, (max. 32 characters)	Specify the name of the primary trap server used by your network.	None

Mode

Setting	Description	Factory Default
Trap V1	Set the trap version to Trap V1.	None
Trap V2c	Set the trap version to Trap v2c.	
Inform V2c	Set the inform version to Inform V2c.	
Trap V3	Set the trap version to Trap V3.	
Inform V3	Set the inform version to Inform V3.	

Trap Community

Setting	Description	Factory Default
At least 4 characters, (max. 30 characters)	Specify the community string that will be used for authentication.	None

When finished, click **CREATE**.

SNMP Trap Account Settings

Click **SNMP Trap/Inform** on the menu, and then click **SNMP Trap/Inform Account** tab. Next click the  icon on the page.

SNMP Trap/Inform

General

SNMP Trap/Inform Account

+

Username	Authentication Type	Encryption Method
Max. 1		

Configure the following settings.

Create SNMP Trap Account Settings

Username *

At least 4 characters 0 / 32

Authentication Type *

None i

Encryption Method

Disabled

CANCEL
CREATE

Username

Setting	Description	Factory Default
At least 4 characters, (max. 30 characters)	Input a username.	None

Authentication type

Setting	Description	Factory Default
None	No authentication type will be used.	None
MD5	MD5 is the authentication type.	
SHA	SHA is the authentication type.	

Authentication Password

Setting	Description	Factory Default
8 to 64 characters	Input the authentication password.	None

Encryption Method

Setting	Description	Factory Default
Disabled	Disable the encryption method.	None
DES	DES is the encryption method.	
AES	AES is the encryption method.	

Encryption Key

Setting	Description	Factory Default
8 to 64 characters	Enable data encryption.	None

When finished, click **CREATE**.

SNMP Inform Settings

First select **SNMP Trap/Inform** on the menu and then click **General**. On the bottom of the page, find the following figure for the settings.

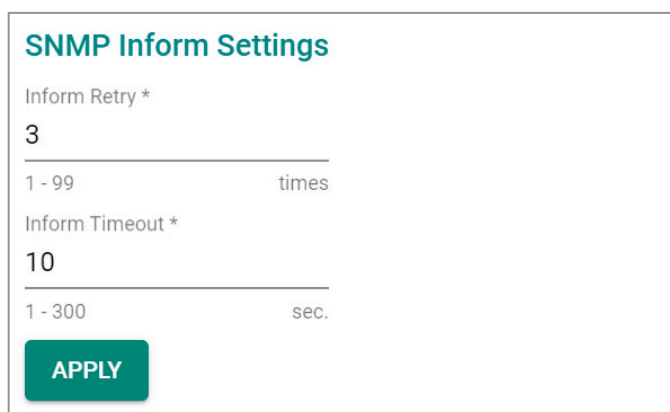

SNMP Inform Settings

Inform Retry *
3
1 - 99 times

Inform Timeout *
10
1 - 300 sec.

APPLY

Configure the following settings.

Inform Retry

Setting	Description	Factory Default
1 to 99	Input the retry value.	3

Inform Timeout

Setting	Description	Factory Default
1 to 300	Input the timeout value.	10

When finished, click **APPLY** to save your changes.

Email Settings

Select **Email Settings** on the function menu and configure the following settings.

Email Settings

Mail Server *
0.0.0.0

TCP Port *
25

1 - 65535

Username Password

0 / 60 0 / 60

TLS Enable *
Disabled ▼

Sender Address
admin@localhost.com

19 / 63

1st Recipient Email Add... 2nd Recipient Email Ad... 3rd Recipient Email Add...

0 / 63 0 / 63 0 / 63

4th Recipient Email Add... 5th Recipient Email Add...

0 / 63 0 / 63

APPLY

Mail Server

Setting	Description	Factory Default
IP address or URL	The IP Address or URL of the email server.	0.0.0.0

TCP Port

Setting	Description	Factory Default
1 to 65535	The TCP port number of your email server.	25

Username

Setting	Description	Factory Default
Max. 60 characters	Your email account name.	None

Password

Setting	Description	Factory Default
Max. 60 characters	Your email account password.	None

TLS Enable

Setting	Description	Factory Default
Enabled	Enable TLS (Transport Layer Security).	Disabled
Disabled	Disable TLS (Transport Layer Security).	

Sender Address

Setting	Description	Factory Default
Max. 60 characters	The sender's email address.	admin@localhost.com

1st to 5th Email Addresses

Setting	Description	Factory Default
Max. 63 characters	You can set up to five email addresses to receive alert emails from the Moxa switch.	None

When finished, click **APPLY** to save your changes.

Relay Output Overview

A relay is an electrically operated switch that often uses an electromagnet to mechanically operate a switch. Relays are used to control a circuit by a separate low-power signal, or where several circuits must be controlled by one signal. This is typically safe when the problem or malfunction occurs on a remote device, providing the protection of the remote switch and secure data communication.

Relay Output and Status

When a relay output is triggered by an event notification, you can cut off the relay via the web interface by selecting the **Relay Output** and clicking **Apply**.

For the MDS-G4000 and MDS-G4000-4XG Series:



Relay Output

Setting	Description	Factory Default
MGMT Relay	Cut off the alarm of the MGMT Relay when triggered by an event notification.	None
PWR1 Relay	Cut off the alarm of the PWR1 Relay when triggered by an event notification.	
PWR2 Relay	Cut off the alarm of the PWR2 Relay when triggered by an event notification.	

For the RKS-G4000 and EDS-(G)4000 Series:





Relay Output

Setting	Description	Factory Default
Relay	Cut off the alarm of the Relay when triggered by an event notification.	None

When finished, click **APPLY** to save your changes.

Go to the **Event Log** section, you can view the relay alarms you have selected to be cut off.

Event Log

Event Log	Oversize-Action	Backup			
  					
Index	Bootup Number	Severity	Timestamp	Uptime	Message
1	23	Notice	2018-12-21 18:56:56	0d0h3m30s	PWR1 Relay relay alarm has been cut off.
2	23	Notice	2018-12-21 18:56:55	0d0h3m30s	PWR2 Relay relay alarm has been cut off.
3	23	Notice	2018-12-21 18:56:55	0d0h3m30s	MGMT Relay relay alarm has been cut off.

Diagnosis

This section explains the configurations for system diagnoses such as **LLDP**, **Port Mirror**, **Ping**, and **ARP Table**.

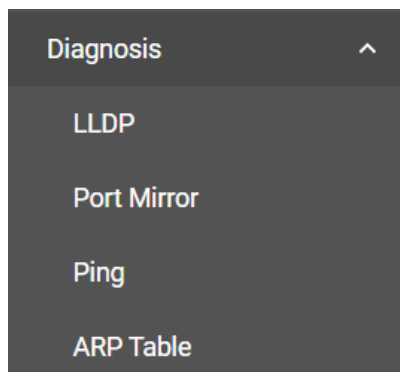

LLDP Overview

LLDP is an OSI Layer 2 protocol defined by IEEE 802.11AB. LLDP standardizes the self-identification advertisement method, and allows each networking device, such as a Moxa managed switch, to periodically send its system and configuration information to its neighbors. Because of this, all LLDP devices are kept informed of each other's status and configurations. With SNMP, this information can be transferred to Moxa's MXview One for auto-topology and network visualization.

From the switch's web interface, you can enable or disable LLDP, and set the LLDP transmit interval. In addition, you can view each switch's neighbor-list, which is reported by its network neighbors. Most importantly, enabling the LLDP function allows Moxa's MXview One to automatically display the network's topology and system setup details, such as VLAN and Trunking for the entire network.

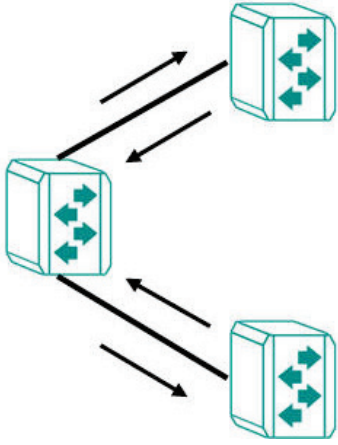

LLDP Settings and Status

LLDP Settings

Click **LLDP** on the menu and then select the **Setting** tab to configure the following settings.

For the RKS-G4000 Series, MDS-G4000 Series, and MDS-G4000-4XG Series:

LLDP

Settings
Status

LLDP *
Enabled

LLDP Version *
v1(2005)

Transmit Interval *	Notification Interval *	Tx Delay *
30	5	2
<small>5 - 32768 sec.</small>	<small>5 - 3600 sec.</small>	<small>1 - 8192 sec.</small>

Reinitialization Delay *	Holdtime Multiplier *	
2	4	
<small>1 - 10 sec.</small>	<small>2 - 10 times</small>	

Chassis ID Subtype *
MAC-Address

APPLY

For the EDS-4000 Series and EDS-G4000 Series:

LLDP

Settings
Status
Neighbor Status

LLDP *
Enabled

LLDP Version *
v1(2005)

Transmit Interval *	Notification Interval *	Tx Delay *
30	5	2
<small>5 - 32768 sec.</small>	<small>5 - 3600 sec.</small>	<small>1 - 8192 sec.</small>

Chassis ID Subtype *
MAC-Address

APPLY

Enable

Setting	Description	Factory Default
Enabled	Enable LLDP.	Disabled
Disabled	Disable LLDP.	

LLDP Version

Setting	Description	Factory Default
LLDP version	Show the LLDP version automatically.	V1(2005)

Transmit Interval (sec.)

Setting	Description	Factory Default
5 to 32768	Set the transmit interval of LLDP messages	30

Notification Interval (sec.)

Setting	Description	Factory Default
5 to 3600	Specify the notification interval.	5

Tx Delay (sec.)

Setting	Description	Factory Default
1 to 8192	Specify the Tx delay interval.	2

Reinitialization Delay (sec.)

Setting	Description	Factory Default
1 to 10	Specify the LLDP reinitialization delay interval.	2

Holdtime Multiplier





Setting	Description	Factory Default
2 to 10	Specify the holdtime multiplier value.	4

Chassis ID Subtype

Setting	Description	Factory Default
Chassis-Component	Select Chassis-Component as Chassis ID subtype.	Mac-Addr
If-Alias	Select If-Alias as Chassis ID subtype.	
Port-Component	Select Port-Component as Chassis ID subtype.	
MAC-Addr	Select MAC-Address as Chassis ID subtype.	
Network Address	Select Network Address as Chassis ID subtype.	
If-Name	Select If-Name as Chassis ID subtype.	
Local	Select Local as Chassis ID subtype.	

When finished, click **APPLY** to save your changes.

Each port for the LLDP settings can also be configured. Select  icon for the port you want to configure.

Port	Port Status
 1/1	Tx and Rx
 1/2	Tx and Rx
 1/3	Tx and Rx
 1/4	Tx and Rx

Configure the following settings.

Edit Port 1/1 Settings

Port Status *
Tx and Rx

Subtype *
If-Alias

TLV *
Basic

Transmit TLVs

Port Description

System Name

System Description

System Capability

Copy Configurations ... 

CANCEL **APPLY**

Port Status

Setting	Description	Factory Default
Tx Only	Set Tx as the port status.	Tx and Rx
Rx Only	Set Rx as the port status.	
Tx and Rx	Set both Tx and Rx as the port status.	

Subtype

Setting	Description	Factory Default
If-Alias	Select If-Alias as the subtype.	If-Alias
Port-Component	Select Port-Component as the subtype.	
MAC-Addr	Select MAC-Address as the subtype.	
If-Name	Select If-Name as the subtype.	
Local	Select Local as the subtype.	

TLV

Setting	Description	Factory Default
Basic	Set TLV as Basic.	Basic
802.1	Set TLV as 802.1.	
802.3	Set TLV as 802.3.	

Transmit TLVs

Setting	Description	Factory Default
Port Description	Add a port description for the TLV.	Port Description System Name
System Name	Add a system name for the TLV.	
System Description	Add a system description for the TLV.	
System Capability	Add a system capability for the TLV.	

Copy Configurations to Port

Setting	Description	Factory Default
---------	-------------	-----------------

Select the port from the list	Copy the same configurations to other port(s).	None
-------------------------------	--	------

When finished, click **APPLY** to save your changes.

LLDP Status

To view the LLDP status, click the **Status** tab on the LLDP page, and the status of all LLDP will be shown on the page.

For the RKS-G4000 Series, MDS-G4000 Series, and MDS-G4000-4XG Series:

The screenshot shows the LLDP Status page with three tabs: Settings, Status (selected), and Neighbor Status. The Status tab is active, displaying three columns of information:

- Local Information:** LLDP is Enabled. LLDP Version is v1(2005). Chassis ID Subtype is MAC-Address. Chassis ID is 00:90:e8:10:50:99.
- Local Timer:** Transmit Interval is 30 (sec.). Notification Interval is 5 (sec.). Tx Delay is 2 (sec.). Reinitialization Delay is 2 (sec.). Holdtime Multiplier is 4 (times).
- Remote Table Statistics:** Last Change Time (ms) is 17540000. Inserts is 7. Drops is 0. Delete is 5. Ageouts is 0.

For the EDS-4000 Series and EDS-G4000 Series:

The screenshot shows the LLDP Status page with three tabs: Settings, Status (selected), and Neighbor Status. The Status tab is active, displaying three columns of information:

- Local Information:** LLDP is Enabled. LLDP Version is v1(2005). Chassis ID Subtype is MAC-Address. Chassis ID is 00:90:e8:8f:44:85. System Capability is Bridge. Interface ID / Management Address is 22 / 10.123.13.114.
- Local Timer:** Transmit Interval is 30 (sec.). Notification Interval is 5 (sec.). Tx Delay is 2 (sec.). Reinitialization Delay is 2 (sec.). Holdtime Multiplier is 4 (times).
- Remote Table Statistics:** Last Change Time (ms) is 6761700. Inserts is 3. Drops is 0. Delete is 2. Ageouts is 0.

Refer to the following table for the detailed description of each item.













Local Information	
Enable	Show if LLDP has been enabled or disabled.
LLDP Version	Show the LLDP version.
Chassis ID Subtype	Show the chassis ID subtype.
Chassis ID	Show the chassis ID.

Local Timer	
Transmit Interval (sec.)	The interval between regular LLDP packet transmissions.
Notification Interval (sec.)	The interval that notifications will be sent.
Tx Delay (sec.)	The delay period between successive LLDP frame transmissions initiated by changes.
Reinitialization Delay (sec.)	The interval an LLDP port waits before re-initializing an LLDP packet transmission.
Holdtime Multiplier	The amount of time that the receiving device holds an LLDP packet before discarding it.

Remote Table Statistics	
Last Change Time (ms.)	The last time the remote table changed.
Inserts	How many inserts have occurred.
Drop	How many drops have occurred.
Delete	How many deletes have occurred.
Ageouts	How many ageouts have occurred.

To view the LLDP status for a specific port, click the detailed information icon on the port. All information will be shown on the right side of the page.

For the RKS-G4000 Series, MDS-G4000 Series, and MDS-G4000-4XG Series:

Port	Tx Status	Rx Status	Nbr. Port ID	Nbr. Chassis ID
 1/1	Enabled	Enabled	28:d2:44:5e:8b:40	28:d2:44:5e:8b:40
 1/2	Enabled	Enabled		
 1/3	Enabled	Enabled		
 1/4	Enabled	Enabled		
 2/1	Enabled	Enabled		
 2/2	Enabled	Enabled		
 2/3	Enabled	Enabled		
 2/4	Enabled	Enabled		
 3/1	Enabled	Enabled		
 3/2	Enabled	Enabled		
 3/3	Enabled	Enabled		
 3/4	Enabled	Enabled		
 4/1	Enabled	Enabled		

Detail Information

Port Local Interface

Port ID SubType
Chassis-Component

Port ID
Eth1/1

Port Description
Ethernet Interface Port 01

Extended 802.1 TLV

Port VLAN ID
1

VLAN ID / Name
1 / factory

Extended 802.3 TLV

Aggregated and Status
Disabled

Aggregated Port Id
0

Maximum Frame Size
1522

For the EDS-4000 Series and EDS-4000 Series:

🔄 🏠
🔍 Search

Port	Tx Status	Rx Status
G1	Enabled	Enabled
G2	Enabled	Enabled
G3	Enabled	Enabled
G4	Enabled	Enabled
1	Enabled	Enabled
2	Enabled	Enabled
3	Enabled	Enabled
4	Enabled	Enabled
5	Enabled	Enabled
6	Enabled	Enabled
7	Enabled	Enabled
8	Enabled	Enabled

Detailed information

Port Local Interface

Port ID SubType
If-Alias

Port ID
Eth1/1

Port Description
Ethernet Interface Port 01

Extended 802.1 TLV

Port VLAN ID
1

VLAN ID / Name
1 /

Extended 802.3 TLV

Link Aggregation Status
Disabled

Aggregated Port ID
0

Maximum Frame Size
9216

Port Traffic Statistics

Total Frames Out
0

For the EDS-4000 Series and EDS-G4000 Series after v4.1:

Port	Tx Status	Rx Status
<div style="border: 1px solid #ccc; padding: 5px;"> <p>📄 G1</p> <p>Port Local Interface</p> <p>Port ID SubType If-Alias</p> <p>Port ID Eth1/1</p> <p>Port Description Ethernet Interface Port 01 - 1000FX,miniGBIC</p> <p>Extended 802.1 TLV</p> <p>Port VLAN ID 1</p> <p>VLAN ID / Name 1 / ---</p> <p>Extended 802.3 TLV</p> <p>Link Aggregation Status Disabled</p> <p>Aggregated Port ID 0</p> <p>Maximum Frame Size 9216</p> <p>Port Traffic Statistics</p> <p>Total Frames Out 3076</p> <p>Total Entries Aged 1</p> <p>Total Frames In 3072</p> <p>Total Frames Received In Error 0</p> <p>Total Frames Discarded 0</p> <p>Total TLVs Unrecognized 3072</p> <p>Total TLVs Discarded 0</p> <p>Extended Ethernet/IP TLV</p> <p>Vendor ID 991</p> <p>Device Type 44</p> <p>Product Code 4362</p> <p>Major Revision 1</p> <p>Minor Revision 0</p> <p>Serial Number 1039324</p> </div>	Enabled	Enabled
G2	Enabled	Enabled
G3	Enabled	Enabled
G4	Enabled	Enabled

LLDP Neighbor Status

To view the neighbor status, click the **Neighbor Status** tab on the **LLDP** page. The Neighbor Status page shows information about all monitored LLDP neighbor switches.



NOTE

For the EDS-4000 and EDS-G4000 Series only.

LLDP

Settings	Status	Neighbor Status																																																																										
<div style="display: flex; justify-content: space-between; align-items: center;"> ↻ 🔍 </div> <table border="1"> <thead> <tr> <th>Local Port</th> <th>System Capability</th> <th>Neighbor Port ID</th> <th>Neighbor Chassis ID</th> <th>Port Description</th> <th>System Name</th> <th>Hold Time</th> </tr> </thead> <tbody> <tr> <td>ⓘ G1</td> <td>Bridge</td> <td>Eth1/6</td> <td>00:90:e8:16:01:00</td> <td>Ethernet Interface Port 06 - SFP-1GLXLC-T</td> <td>moxa</td> <td>120</td> </tr> <tr> <td>ⓘ G2</td> <td>---</td> <td>---</td> <td>---</td> <td>---</td> <td>---</td> <td>---</td> </tr> <tr> <td>ⓘ G3</td> <td>---</td> <td>---</td> <td>---</td> <td>---</td> <td>---</td> <td>---</td> </tr> <tr> <td>ⓘ G4</td> <td>---</td> <td>---</td> <td>---</td> <td>---</td> <td>---</td> <td>---</td> </tr> <tr> <td>ⓘ 1</td> <td>---</td> <td>---</td> <td>---</td> <td>---</td> <td>---</td> <td>---</td> </tr> <tr> <td rowspan="2">ⓘ 2</td> <td rowspan="2">Bridge</td> <td rowspan="2">Eth1/1</td> <td rowspan="2">00:01:02:03:04:05</td> <td rowspan="2">Ethernet Interface Port 01 - 1000TX,RJ45</td> <td rowspan="2">moxa</td> <td rowspan="2">120</td> </tr> <tr> <td colspan="6"> <div style="border: 1px solid #ccc; padding: 5px;"> <p>Management Address Table</p> <p>Interface ID / Management Address 22 / 192.168.127.203</p> <p>Extended Ethernet/IP TLV</p> <table border="1"> <thead> <tr> <th>Vendor ID</th> <th>Device Type</th> <th>Product Code</th> <th>Major Revision</th> <th>Minor Revision</th> <th>Serial Number</th> </tr> </thead> <tbody> <tr> <td>991</td> <td>44</td> <td>4367</td> <td>0</td> <td>0</td> <td>0</td> </tr> </tbody> </table> </div> </td> </tr> <tr> <td>ⓘ 3</td> <td>---</td> <td>---</td> <td>---</td> <td>---</td> <td>---</td> <td>---</td> </tr> </tbody> </table>			Local Port	System Capability	Neighbor Port ID	Neighbor Chassis ID	Port Description	System Name	Hold Time	ⓘ G1	Bridge	Eth1/6	00:90:e8:16:01:00	Ethernet Interface Port 06 - SFP-1GLXLC-T	moxa	120	ⓘ G2	---	---	---	---	---	---	ⓘ G3	---	---	---	---	---	---	ⓘ G4	---	---	---	---	---	---	ⓘ 1	---	---	---	---	---	---	ⓘ 2	Bridge	Eth1/1	00:01:02:03:04:05	Ethernet Interface Port 01 - 1000TX,RJ45	moxa	120	<div style="border: 1px solid #ccc; padding: 5px;"> <p>Management Address Table</p> <p>Interface ID / Management Address 22 / 192.168.127.203</p> <p>Extended Ethernet/IP TLV</p> <table border="1"> <thead> <tr> <th>Vendor ID</th> <th>Device Type</th> <th>Product Code</th> <th>Major Revision</th> <th>Minor Revision</th> <th>Serial Number</th> </tr> </thead> <tbody> <tr> <td>991</td> <td>44</td> <td>4367</td> <td>0</td> <td>0</td> <td>0</td> </tr> </tbody> </table> </div>						Vendor ID	Device Type	Product Code	Major Revision	Minor Revision	Serial Number	991	44	4367	0	0	0	ⓘ 3	---	---	---	---	---	---
Local Port	System Capability	Neighbor Port ID	Neighbor Chassis ID	Port Description	System Name	Hold Time																																																																						
ⓘ G1	Bridge	Eth1/6	00:90:e8:16:01:00	Ethernet Interface Port 06 - SFP-1GLXLC-T	moxa	120																																																																						
ⓘ G2	---	---	---	---	---	---																																																																						
ⓘ G3	---	---	---	---	---	---																																																																						
ⓘ G4	---	---	---	---	---	---																																																																						
ⓘ 1	---	---	---	---	---	---																																																																						
ⓘ 2	Bridge	Eth1/1	00:01:02:03:04:05	Ethernet Interface Port 01 - 1000TX,RJ45	moxa	120																																																																						
							<div style="border: 1px solid #ccc; padding: 5px;"> <p>Management Address Table</p> <p>Interface ID / Management Address 22 / 192.168.127.203</p> <p>Extended Ethernet/IP TLV</p> <table border="1"> <thead> <tr> <th>Vendor ID</th> <th>Device Type</th> <th>Product Code</th> <th>Major Revision</th> <th>Minor Revision</th> <th>Serial Number</th> </tr> </thead> <tbody> <tr> <td>991</td> <td>44</td> <td>4367</td> <td>0</td> <td>0</td> <td>0</td> </tr> </tbody> </table> </div>						Vendor ID	Device Type	Product Code	Major Revision	Minor Revision	Serial Number	991	44	4367	0	0	0																																																				
Vendor ID	Device Type	Product Code	Major Revision	Minor Revision	Serial Number																																																																							
991	44	4367	0	0	0																																																																							
ⓘ 3	---	---	---	---	---	---																																																																						

LLDP

Settings	Status	Neighbor Status																																																																	
<div style="display: flex; justify-content: space-between; align-items: center;"> ↻ 🔍 🔍 Search </div> <table border="1"> <thead> <tr> <th>Local Port</th> <th>System Capability</th> <th>Neighbor Port ID</th> <th>Neighbor Chassis ID</th> <th>Hold Time</th> </tr> </thead> <tbody> <tr><td>🔍 G1</td><td>---</td><td>---</td><td>---</td><td>---</td></tr> <tr><td>🔍 G2</td><td>---</td><td>---</td><td>---</td><td>---</td></tr> <tr><td>🔍 G3</td><td>---</td><td>---</td><td>---</td><td>---</td></tr> <tr><td>🔍 G4</td><td>---</td><td>---</td><td>---</td><td>---</td></tr> <tr><td>🔍 1</td><td>---</td><td>---</td><td>---</td><td>---</td></tr> <tr><td>🔍 2</td><td>---</td><td>---</td><td>---</td><td>---</td></tr> <tr><td>🔍 3</td><td>---</td><td>---</td><td>---</td><td>---</td></tr> <tr><td>🔍 4</td><td>---</td><td>---</td><td>---</td><td>---</td></tr> <tr><td>🔍 5</td><td>---</td><td>---</td><td>---</td><td>---</td></tr> <tr><td>🔍 6</td><td>Other</td><td>Eth3/2</td><td>00:90:e8:10:50:99</td><td>---</td></tr> <tr><td>🔍 7</td><td>---</td><td>---</td><td>---</td><td>---</td></tr> <tr><td>🔍 8</td><td>---</td><td>---</td><td>---</td><td>---</td></tr> </tbody> </table>			Local Port	System Capability	Neighbor Port ID	Neighbor Chassis ID	Hold Time	🔍 G1	---	---	---	---	🔍 G2	---	---	---	---	🔍 G3	---	---	---	---	🔍 G4	---	---	---	---	🔍 1	---	---	---	---	🔍 2	---	---	---	---	🔍 3	---	---	---	---	🔍 4	---	---	---	---	🔍 5	---	---	---	---	🔍 6	Other	Eth3/2	00:90:e8:10:50:99	---	🔍 7	---	---	---	---	🔍 8	---	---	---	---
Local Port	System Capability	Neighbor Port ID	Neighbor Chassis ID	Hold Time																																																															
🔍 G1	---	---	---	---																																																															
🔍 G2	---	---	---	---																																																															
🔍 G3	---	---	---	---																																																															
🔍 G4	---	---	---	---																																																															
🔍 1	---	---	---	---																																																															
🔍 2	---	---	---	---																																																															
🔍 3	---	---	---	---																																																															
🔍 4	---	---	---	---																																																															
🔍 5	---	---	---	---																																																															
🔍 6	Other	Eth3/2	00:90:e8:10:50:99	---																																																															
🔍 7	---	---	---	---																																																															
🔍 8	---	---	---	---																																																															

Detailed Information

Management Address Table

Interface ID

Management Address

Extended Ethernet/IP TLV

Vendor ID

Device Type

Product Code

Major Revision

Minor Revision

Serial Number

Port Mirroring

Port Mirroring Overview

The **Port Mirroring** function can be used to monitor data being transmitted through a specific port. This is done by setting up another port (the mirror port) to receive the same data being transmitted from, or both to and from, the port under observation. Using a mirror port allows the network administrator to sniff the observed port to keep tabs on network activity.

The Port Mirroring function includes two features:

SPAN (Switched Port Analyzer): Mirroring data of monitored ports to multiple terminal ports on the same switch. Five sessions are allowed to be configured in a switch.

RSPAN (Remote Switched Port Analyzer): Mirroring data of monitored ports on one switch to multiple terminal ports on the other switches. Two sessions are allowed to be configured in a switch.

How Port Mirroring Works

SPAN can be configured to copy packets from various ports to a single port or multiple ports, so that users can check if there are problems occurring in these ports. For example, the following figure demonstrates how the packets transmitted in the four mirrored ports (marked in orange) are copied (mirrored) to a single mirroring port (marked in green). These packets will be sent to a monitoring computer and then software is used to check if there is something wrong with these packets. It is a useful function to troubleshoot or debug a network data transmission issue.

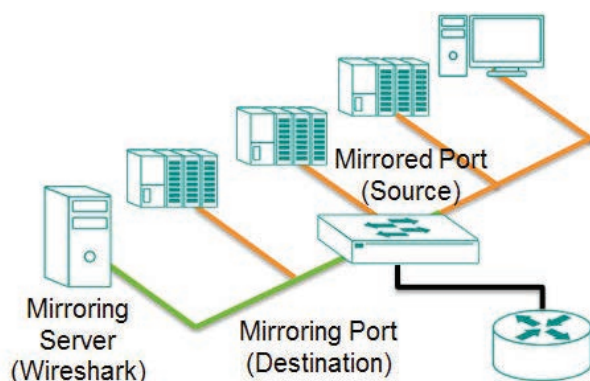

RSPAN can be configured to copy packets from various ports in one or more source switches through intermediate switches to a single or multiple port(s) to destination switches. The PC or monitor server can be connected to destination ports in the destination switch to receive the copy of the original monitored traffic. For example, the following figure demonstrates how the packets transmitted in mirrored ports (marked in blue) are copied (mirrored) through an intermediate switch to two mirroring ports (marked in green).

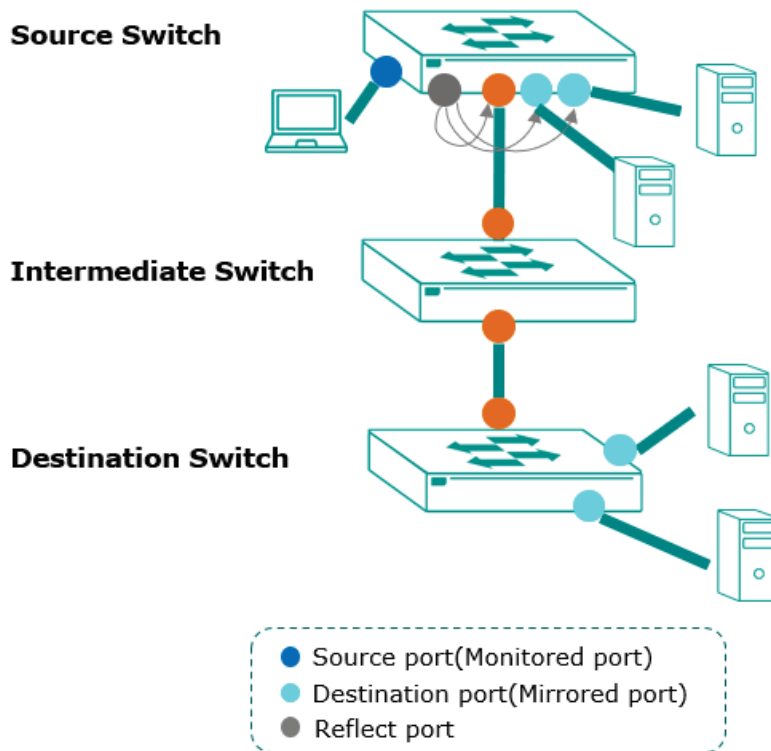

- Users can set source ports in one or more RSPAN source switches. Enable reflect port for multiple designated ports, or disable reflect port for a single designated port.
- Users can configure RSPAN VLAN for monitored traffic to be labeled with a RSPAN VLAN tag and send to an RSPAN destination switch via trunk ports.
- Users can connect a PC that has the server monitoring feature for the ports that are set to be the destination ports to receive the monitored traffic.
- The monitor traffic will be stripped off RSPAN VLAN tag and then the PC or monitor server will receive a copy of the original monitored traffic.

Port Mirroring Settings

The Port Mirroring function includes SPAN and RSPAN which share the same global settings.

Click **Port Mirroring** on the menu and then configure the settings.

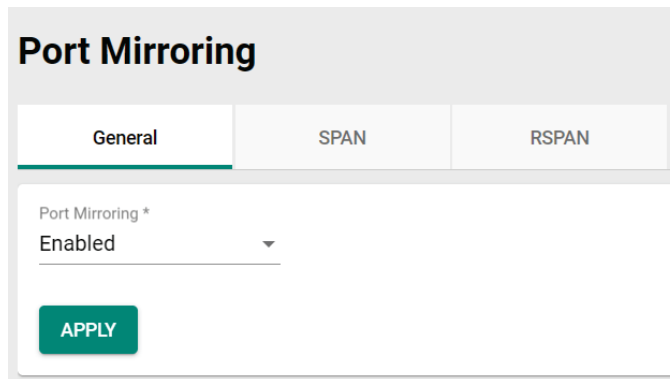

Port Mirroring

General SPAN RSPAN

Port Mirroring *
Enabled

APPLY

Port Mirroring

Setting	Description	Factory Default
Enabled	Enable Port Mirror.	Enabled
Disabled	Disable Port Mirror.	

When finished, click **APPLY** to save your changes.

Configure SPAN

To configure the SPAN settings, click the SPAN tab, and then click  icon.

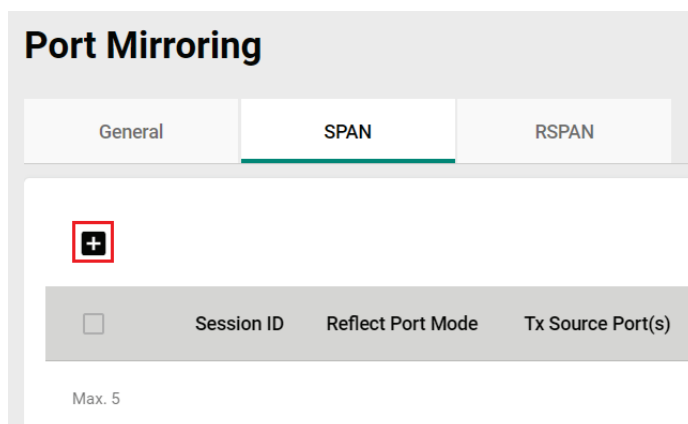

Port Mirroring

General **SPAN** RSPAN



<input type="checkbox"/>	Session ID	Reflect Port Mode	Tx Source Port(s)
--------------------------	------------	-------------------	-------------------

Max. 5

Configure the following settings.

Create Session

Session ID * ▼

Reflect Port Mode * ▼

Tx Source Port(s) ▼ Rx Source Port(s) ▼

Destination Port * ▼

Either the TX or RX source ports need to be selected.

CANCEL
CREATE

Session ID

Setting	Description	Factory Default
Select from the drop-down list	Select the session ID from the dropdown list (1 to 5). SPAN and RSPAN share 7 sessions, SPAN uses 1 to 5, and RSPAN uses 6 and 7.	None

Reflect Port Mode

Setting	Description	Factory Default
Enable	Enable Reflect Port Mode and configure the Reflect Port for mirroring packets to multiple destination ports.	None
Disable	Disable the Reflect Port Mode for mirroring packets to a single destination port.	

Tx Source Port

Setting	Description	Factory Default
Select the port from the list	Select this option to monitor only those data packets being sent out through the switch's port.	None

Rx Source Port

Setting	Description	Factory Default
Select the port from the list	Select this option to monitor only those data packets coming into the switch's port.	None

Reflect Port

Setting	Description	Factory Default
Select the port from the list	Specify this port as the Reflect Port after enabling Reflect Port Mode for mirroring packets to multiple destination ports. This port will be reserved for Reflect Port use and should not be configured for any other purpose.	None



NOTE

The port LED indicator will light up when the port is configured as a reflect port even though there is no cable connected. Reflect ports on the EDS-(G)4000 Series do not have communication functionality and cannot be used as communication ports. It is not recommended using reflect ports as communicating port on the RKS-G4000 Series, MDS-G4000 Series, and MDS-G4000-4XG Series.

Destination Port

Setting	Description	Factory Default
Select the destination port from the list	Specify the port as the destination port.	None

When finished, click **CREATE** to save your changes.

The following steps demonstrate how to copy packets from one or more source port(s) (monitored ports) to a single destination port (mirror port):

1. Select Session ID from drop list (1 to 5)
2. Disable Reflect Port Mode
3. Select the monitored packet source port(s), you can select either Tx source port(s) or Rx source port(s), or both.
 - If Tx source port(s) is selected, the egress traffic on the port(s) will be mirrored to the destination port.
 - If the Rx source port(s) is selected, the ingress traffic on the port(s) will be mirrored to the destination port.
4. Select the destination port, which is required to be access port.



NOTE

The duplication of source port(s) configured in different sessions is not allowed. The duplication of source port(s) and destination ports in different sessions is not allowed.

The following steps demonstrate how to copy packets from one or more source port(s) (monitored ports) to multiple destination ports:

1. Select Session ID from drop list (1~5)
2. Enable Reflect Port Mode
3. Select the monitored packet source port(s), you can select either Tx source port(s) or Rx source port(s), or both. The source port(s) must be the access port(s).
 - If Tx source port(s) is selected, the egress traffic on the port(s) will be mirrored to the reflect port.
 - If the Rx source port(s) is selected, the ingress traffic on the port(s) will be mirrored to the reflect port.
4. Select the reflect port, which is required to be an access port. The port is specifically reserved for Reflect Port use, please do not configure for other use.
5. Go to the VLAN page, configure the port(s) required to receive the packets from source ports as the member port of the same VLAN ID as reflect port.



NOTE

The duplication of source port(s) configured in different sessions is not allowed. The duplication of source port(s), reflect port, and destination ports in different sessions is not allowed.

Configure RSPAN

To configure the RSPAN settings, click RSPAN.

Port Mirroring

General
SPAN
RSPAN

RSPAN Intermediate Settings

All VLAN trunk ports will be added into the RSPAN VLAN.

RSPAN Intermediate Role *

Disabled ▼

RSPAN Intermediate VLAN ID

- ▼

APPLY

Configure the following settings. Users need to decide the switch role for RSPAN first, the switch roles are Source switch, Intermediate switch, and Destination switch.

RSPAN Intermediate Role

Setting	Description	Factory Default
Enable	Enable the RSPAN intermediate role if the switch role is intermediate role.	Disabled
Disable	Disable the RSPAN intermediate role if the switch role is the source or destination role.	

If you enable the RSPAN intermediate role, the existing RSPAN session in this switch will be deleted. Click **CONFIRM** to continue.

Enable RSPAN Intermediate Role

This setting will delete all existing RSPAN sessions. Are you sure to proceed?

CANCEL
CONFIRM

RSPAN Intermediate VLAN ID

Setting	Description	Factory Default
Select the port from the list	Specify the VLAN ID as the RSPAN intermediate VLAN ID. The RSPAN intermediate VLAN ID cannot be the management VLAN ID.	None

Next, click  icon to create the session.

Create Session

Session ID * ▼

Reflect Port Mode * ▼

RSPAN Type * ▼

RSPAN VLAN ID * ▼

Tx Source Port(s) ▼ Rx Source Port(s) ▼

Designated Port * ▼

Either the TX or RX source ports need to be selected.

CANCEL
CREATE

Session ID

Setting	Description	Factory Default
Select from the drop-down list	Select the session ID from the dropdown list (6 to 7). SPAN and RSPAN share 7 sessions, SPAN uses 1 to 5, and RSPAN uses 6 and 7.	None

Reflect Port Mode

Setting	Description	Factory Default
Enable	Enable Reflect Port Mode and configure Reflect Port for mirroring packets to multiple designated ports.	None
Disable	Disable Reflect Port Mode for mirroring packets to a single designated port.	



NOTE

The port LED indicator will light up when the port is configured as a reflect port even though there is no cable connected. Reflect ports on the EDS-(G)4000 Series do not have communication functionality and cannot be used as communication ports. It is not recommended using reflect ports as communicating port on the RKS-G4000 Series, MDS-G4000 Series, and MDS-G4000-4XG Series.

RSPAN Type

Setting	Description	Factory Default
Source	Specify the RSPAN type as Source if the switch role is RSPAN source switch.	None
Destination	Specify the RSPAN type as Destination if the switch role is the RSPAN destination switch.	

RSPAN VLAN ID

Setting	Description	Factory Default
Select the ID from the list	Select the VLAN ID as the RSPAN VLAN ID. The RSPAN VLAN ID cannot be the management VLAN ID.	None

Tx Source Port

Setting	Description	Factory Default
Select the port from the list	Select this option to monitor only those data packets being sent out through the switch's port.	None

Rx Source Port

Setting	Description	Factory Default
Select the port from the list	Select this option to monitor only those data packets coming into the switch's port.	None

Reflect Port

Setting	Description	Factory Default
Select the port from the list	Specify this port as the Reflect Port after enabling Reflect Port Mode for mirroring packets to multiple destination ports. This port will be reserved for Reflect Port use and should not be configured for any other purpose.	None

Designated Port

Setting	Description	Factory Default
Select the port from the list	Specify this port as the designated port.	None

When finished, click **CREATE** to create the RSPAN session.

To configure RSPAN, users need to decide the switch role first. Here are two scenarios:

1. To copy packets from one or more source port(s) (monitored ports) to a single designated port (mirror port).
2. To copy packets from one or more source port(s) to multiple designated ports.

The different configuration steps between the two scenarios are configuring the source switch. The other configuration steps for configuring the intermediate switch and destination switch are the same. The following are the configuration steps:

To configure source switch for scenario 1: To copy packets to a single designated port (mirror port).

1. Select Session ID from drop list (6 and 7). The session can be different between the source switch, intermediate switch, and destination switch for the same mirroring traffic.
2. Disable Reflect Port Mode
3. Select Source as RSPAN Type.
4. The RSPAN type cannot be duplicated in different RSPAN sessions.
5. Select RSPAN VLAN which cannot be the management VLAN. The VLAN cannot be duplicated in different RSPAN sessions. The RSPAN VLAN must be the same for any traffic that travels between the source switch, the intermediate switch, and the destination switch.
6. Select the monitored packet source port(s), you can select either Tx source port(s) or Rx source port(s), or both.
 - If Tx source port(s) is selected, the egress traffic on the port(s) will be mirrored to a designated port.
 - If the Rx source port(s) is selected, the ingress traffic on the port(s) will be mirrored to a designated port.
7. Select the designated port, which is required to be an access port.



NOTE

The duplication of source port(s) configured in different sessions is not allowed. The duplication of source port(s) and designated port(s) in different sessions is not allowed.

To configure source switch for scenario 2: To copy packets to multiple designated ports (mirror port):

1. Select Session ID from drop list (6 and 7). The session can be different between source switch, intermediate switch and destination switch for the same mirroring traffic.
2. Enable Reflect Port Mode
3. Select Source as RSPAN Type
4. Select RSPAN VLAN, which cannot be the management VLAN. The VLAN cannot be duplicated in different RSPAN sessions. The RSPAN VLAN must be the same between source switch, intermediate switch to destination switch for the same mirroring traffic.
5. Select the monitored packet source port(s), you can select either Tx source port(s) or Rx source port(s), or both.
 - If Tx source port(s) is selected, the egress traffic on the port(s) will be mirrored to the reflect port.
 - If the Rx source port(s) is selected, the ingress traffic on the port(s) will be mirrored to the reflect port.
6. Select the reflect port, which is required to be trunk port. The port is reserved for reflect traffic to designated ports use, please do not configure for other use.
7. Go to the VLAN page, configure the ports required to receive the packets from source ports as the member port of the same VLAN ID as reflect port.



NOTE

The duplication of source port(s) configured in different sessions is not allowed. The duplication of source port(s), reflect port and destination port(s) and in different sessions is not allowed.

To configure the intermediate switch:

1. Enable the intermediate role for intermediate switch. RSPAN session can be created after enabling the intermediate role in the switch.
2. Select RSPAN VLAN ID which cannot be the management VLAN. The RSPAN VLAN must be the same for the traffic mirrored from source switch, intermediate switch to destination switch.

To configure the destination switch:

1. Select Session ID from drop list (6 and 7); the session can be different for the traffic mirrored from source switch, intermediate switch to destination switch.
2. Select Destination as RSPAN Type. The RSPAN type cannot be duplicated in different RSPAN sessions.
3. Select RSPAN VLAN, which cannot be the management VLAN. The VLAN cannot be duplicated in different RSPAN sessions. The RSPAN VLAN must be the same for the traffic mirrored from source switch, intermediate switch to destination switch.
4. Select the destination port(s) and the ports must be the access port.

Ping

The **Ping** function uses the ping command to give users a simple but powerful tool for troubleshooting network problems. The function most unique feature of the function is that even though the ping command is entered from the user's PC, the actual ping command originates from the Moxa switch itself. This allows the user to essentially sit on top of the Moxa switch and send ping commands out through its ports.

To use the Ping function, click **Ping** on the menu, and enter the IP address or domain name you want to ping. After clicking **Ping**, the result will be shown.

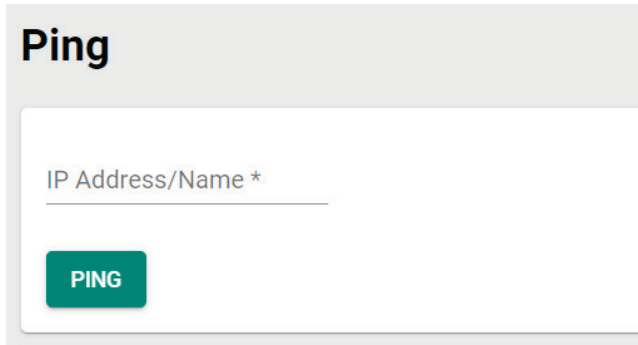

ARP Table

To view the ARP Table, select **ARP Table** and the information will be displayed.



Index	MAC Address	IP Address
1	28:d2:44:5e:8b:40	192.168.127.99

Max 2000

Industrial Applications

This section introduces the settings for **IEC 61850 standard**, **Modbus TCP**, and **EtherNet/IP**.

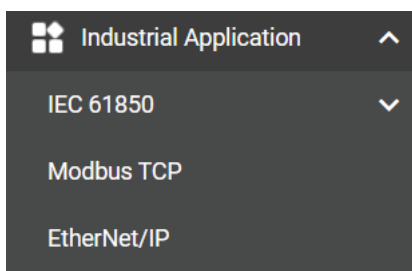

IEC 61850

Click **MMS** in the function menu under **Industrial Application** and **IEC 61850**.

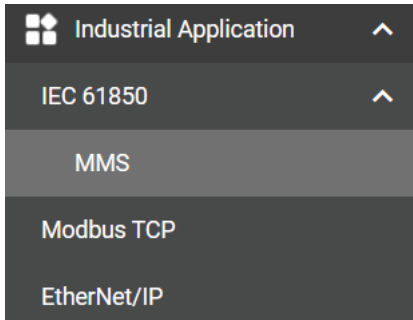

MMS Settings

Click the **General** tab for further configurations.

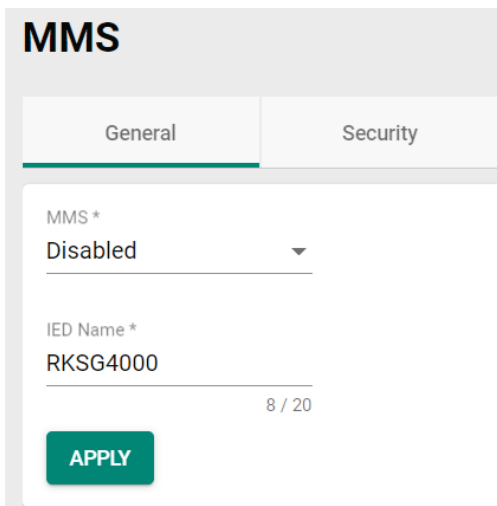

Configure the following settings.

MMS

Setting	Description	Factory Default
Enabled	Enable MMS function on the switch.	Disabled
Disabled	Disable MMS function on the switch.	





IED Name

Setting	Description	Factory Default
0 to 20 characters	Provide the IED name for your switch.	RKS-G4000 (Will vary depending on the switch models)

When finished, click **APPLY** to save your changes.

CID File Settings

Click the edit icon  on the page.

CID File Settings	
Report Control Block	Data Change
 urcbLnkSt	Enabled
 brcbLnkSt	Enabled
 urcbSysSt	Enabled
 brcbSysSt	Enabled

Configure the following settings.

Edit urcbLnkSt

Data Change *
Enabled

Data Update *
Disabled

Quality Change *
Disabled

Integrity *
Enabled

Buffer Time *
1000
1 - 4294967295 ms

Integrity Period *
5000
1 - 4294967295 ms

Data Change

Setting	Description	Factory Default
Enabled	Enable the Data Change function.	Enabled
Disabled	Disable the Data Change function.	

Data Update

Setting	Description	Factory Default
Enabled	Enable Data Update function.	Disabled
Disabled	Disable Data Update function.	

Quality Change

Setting	Description	Factory Default
Enabled	Enable the Quality Change function.	Disabled
Disabled	Disable the Quality Change function.	

Integrity

Setting	Description	Factory Default
Enabled	Enable the Integrity function.	Enabled
Disabled	Disable the Integrity function.	

Buffer Time

Setting	Description	Factory Default
1 to 4294967295 (ms)	Provide the buffer time value.	1000

Integrity Period

Setting	Description	Factory Default
1 to 4294967295 (ms)	Provide the integrity period value.	5000

When finished, click **APPLY** to save your changes.

Exporting CID File

To export the CID file, click **EXPORT CID FILE**.



The file will be downloaded to your local computer.

Next, click **Security** tab, you can view the information for **T-Profile** and **A-Profile** Certificates.

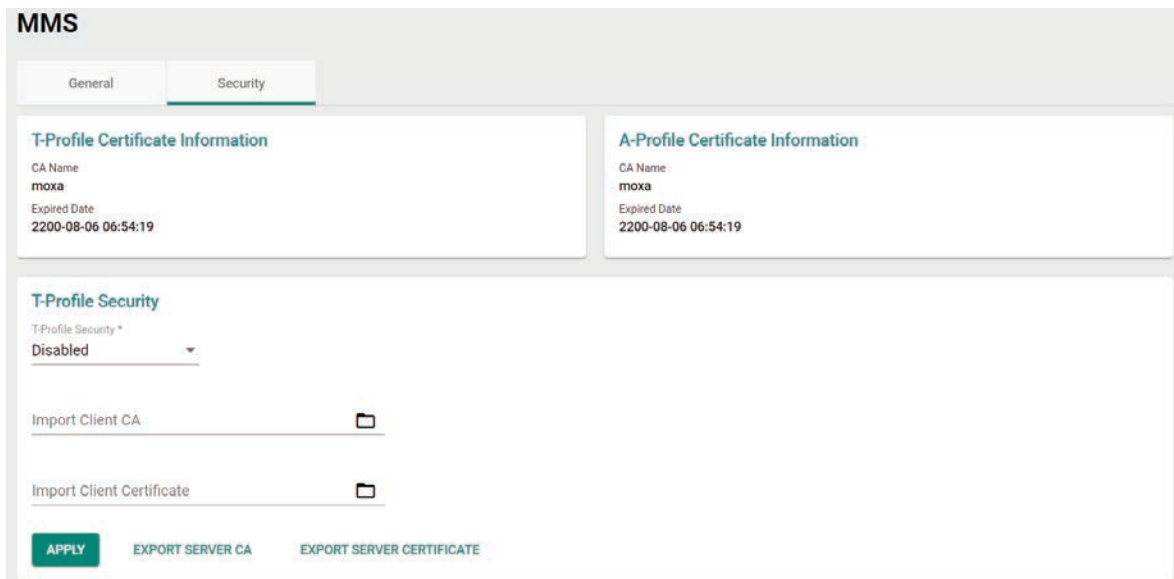
A screenshot of the MMS (Moxa Managed Switch) configuration interface. The "Security" tab is selected. It shows two sections: "T-Profile Certificate Information" and "A-Profile Certificate Information". Both sections show "CA Name: moxa" and "Expired Date: 2200-08-06 06:54:19". Below these is the "T-Profile Security" section, where "T-Profile Security*" is set to "Disabled". There are two file upload fields: "Import Client CA" and "Import Client Certificate", each with a folder icon. At the bottom, there are three buttons: "APPLY" (green), "EXPORT SERVER CA" (grey), and "EXPORT SERVER CERTIFICATE" (grey).

T-Profile Security Settings

Configure the following settings for T-Profile Security.

T-Profile Security

T-Profile Security *
Disabled

Import Client CA

Import Client Certificate

T-Profile Security

Setting	Description	Factory Default
Enabled	Enable T-Profile Security.	Disabled
Disabled	Disable T-Profile Security.	

Import Client CA

Setting	Description	Factory Default
Click the import icon <input type="button" value="📁"/> on the right.	Import Client CA file from your local computer	None

Import Client Certificate

Setting	Description	Factory Default
Click the import icon <input type="button" value="📁"/> on the right.	Import Client Certificate file from your local computer	None

When finished, click **APPLY** to complete.

Export Server CA

To export the Server CA, click **EXPORT SERVER CA**, the file will be downloaded to your local computer.

Export Server Certificate

To export the Server Certificate, click **EXPORT SERVER CERTIFICATE**, the file will be downloaded to your local computer.

A-Profile Security Settings

Configure the following settings for A-Profile Security.

A-Profile Security

A-Profile Security *

Disabled

Import Client CA

Import Client Certificate

A-Profile Security

Setting	Description	Factory Default
Enabled	Enable A-Profile Security.	Disabled
Disabled	Disable A-Profile Security.	

Import Client CA

Setting	Description	Factory Default
Click the import icon <input type="button" value="Folder icon"/> on the right.	Import Client CA file from your local computer	None

Import Client Certificate

Setting	Description	Factory Default
Click the import icon <input type="button" value="Folder icon"/> on the right.	Import Client Certificate file from your local computer	None

When finished, click **APPLY** to complete.

Exporting Server CA

To export Server CA, click **EXPORT SERVER CA**, the file will be downloaded to your local computer.

Exporting Server Certificate

To export Server Certificate, click **EXPORT SERVER CERTIFICATE**, the file will be downloaded to your local computer.

Connecting to an MMS Server

To establish a connection with an external MMS (Manufacturing Message Specification) server, an IEC 61850 client tool is typically used. When using such a tool, the following key parameters must be configured in the tool to ensure a successful connection to the MMS server:

1. IP address and port
 - **IP address:** The network address of the MMS server.

- **Port number:** Typically, MMS communication uses **port 102**, though this can vary depending on the server configuration.
2. Remote AP ID (Application Process Identifier)
 - A unique identifier used in MMS (Manufacturing Message Specification) communication to identify a specific application process on a remote device, such as an MMS server or an IED (Intelligent Electronic Device). The Remote AP ID typically includes the **AP Title** (Application Process Title) and **AE Qualifier** (Application Entity Qualifier). These together form the full identifier for the application process on the remote system.
 - Recommended Remote AP ID settings:
 - v4.1 and earlier: 1.3.9999.1
 - v4.2 and later: no limitation
 - Recommended Remote AE Qualifier settings:
 - v4.1 and earlier: 1
 - v4.2 and later: no limitation
 3. Local AP ID (Application Process identifier)
 - A unique identifier used in MMS (Manufacturing Message Specification) and OSI-based communication to identify the application process on your local device (the client) during communication.
 - Recommended Local AP ID settings:
 - v4.1 and earlier: 1.3.9999.2
 - v4.2 and later: no limitation
 - Recommended Local AE Qualifier settings:
 - v4.1 and earlier: 2
 - v4.2 and later: no limitation
 4. OSI Layer Parameters
 - Since MMS is based on the OSI model, specific OSI parameters are needed:
 - PSEL (Presentation Selector)**
 - SSEL (Session Selector)**
 - TSEL (Transport Selector)**
 - These selectors define how data is routed at different layers of the OSI model. Refer to the table below for recommended settings:

Parameter	Recommended Settings v4.1 and Earlier	Recommended Settings v4.2 and Later
Remote P Selector	8	No limitation
Remote S Selector	1	1
Remote T Selector	1	No limitation
Local P Selector	7	1
Local S Selector	1	1
Local T Selector	1	1

5. Authentication Information (e.g. certificate-based authentication)
 - Refer to [T-Profile Security Settings](#) or [A-Profile Security Settings](#) for relevant settings.

Modbus TCP

Overview

Modbus is a vendor neutral and commonly used communication protocol to monitor and control industrial automation equipment such as PLCs, sensors, and meters. It is a messaging structure used to establish multiple client-server applications to monitor or program devices.

In order to be fully integrated into industrial systems, Moxa's switches support the Modbus TCP/IP protocol for real-time monitoring in a SCADA system.

How Does Modbus Work?

Modbus is a client/server communication structure. Modbus communication is based on transactions built between client and server. The client requests to read or write server data and the server replies with a message to confirm after completing the instruction.

The message format between client/server at a minimum must include Protocol Data Unit (PDU) and may also include Application Data Unit (ADU). The PDU includes function code and data. The function code is the instruction code to read or write server data, and the data includes related parameters for the instruction, such as read the data in certain addresses.

Moxa switches act as the Modbus server to reply to the Modbus client such as for the SCADA's request.

- Supports 5 connections from clients simultaneously.
- Close connection when connection doesn't have any Modbus TCP request receptions for 60 seconds.
- Close all the Modbus TCP connections within 5 seconds when all of the switch ports are link down.
- Support Function Code 4 with 16-bit (2-word) data access for read-only information.

Data Access Type	Function Code	Function Name
Word access (16-bit access)	4	Read Input Registers

- Information support for client to request: System information, port information, packet information, redundancy information. For detailed data map and information, refer to **Appendix D**.

Click **Modbus TCP** on the function menu and configure the following settings.

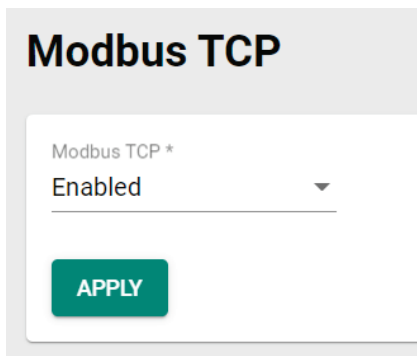

Modbus TCP

Setting	Description	Factory Default
Enabled	Enable Modbus TCP.	Disabled
Disabled	Disable Modbus TCP.	

When finished, click **APPLY** to save your changes.

PROFINET

Overview

PROFINET is an open industrial Ethernet communication protocol proposed by PROFIBUS & PROFINET International (PI), an organization dedicated to industrial communication standards. It is fully compatible with Ethernet as defined in the IEEE standard and has been included in the IEC 61158 and IEC 61784 standards since 2003. PROFINET enables the implementation of applications for production and process automation, safety applications, and a wide range of drive technology.

PROFINET includes three node roles:

IO-Controllers

IO Controllers control the automated tasks of IO Devices and collect relevant information for users.

IO-Supervisors

IP Supervisor is usually PC-based software, which allows users to configure parameters and diagnose the status of individual modules. IO Supervisors do not directly participate in routine operations.

IO-Devices

Controlled and monitored by IO Controllers, an IO Device may include several modules or sub-modules. The Moxa switch is a PROFINET I/O device. A device model describes all field devices in terms of their possible technical and functional features. It is specified by the DAP (Device Access Point) and the defined modules for a particular device family. A DAP is the access point for communication with the Ethernet interface and the processing program.

Device Description

GSD Files

The GSD files (General Station Description) of the field devices to be configured are required for system engineering. This XML-based GSD describes the properties and functions of the PROFINET I/O field devices. It contains all data relevant for engineering as well as for data exchange with the device. Find and download the field device GSD file from the MOXA website.

How Does PROFINET I/O Work?

PROFINET IO operates through IO-Supervisors, IO-Controllers, and IO-Devices, and can fulfill various levels of requirements through periodic and aperiodic data transmission. IO-Devices are standalone units designed to transmit real-time (RT) information to IO-Controllers (PLCs). They do not attempt to communicate directly with other devices. Instead, they directly provide their real-time (cyclic) data to an IO-Controller and may send some alarm or diagnostic (acyclic) data to an IO-Supervisor.

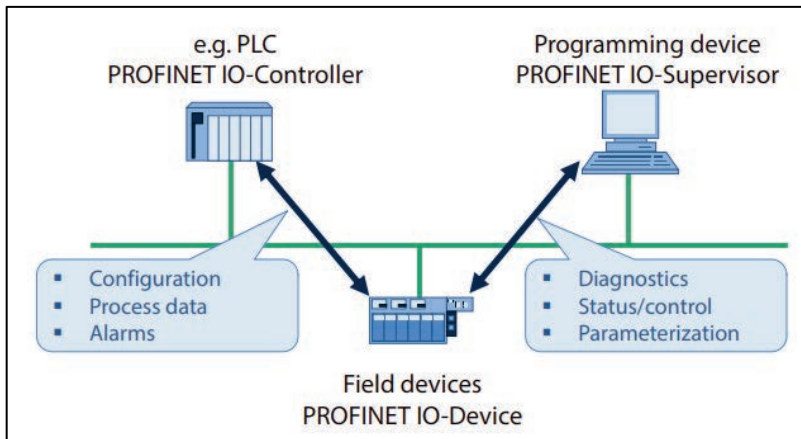

PROFINET-related Protocols

DCP

In PROFINET I/O, each field device has a symbolic name that uniquely identifies the field device within a PROFINET I/O system. This name is used for assigning the IP address. The DCP protocol (Dynamic Configuration Protocol) integrated in every I/O device is used for this purpose. In addition, DCP can perform other tasks such as obtaining information about designated Device Names (IP address, MAC address, Vendor ID and Device ID), flashing LED, and resetting configuration as well. If you enable PROFINET, DCP will be automatically enabled.

Configuring PROFINET Settings

To configure the PROFINET settings, click **PROFINET** in the function menu under **Industrial Application**.

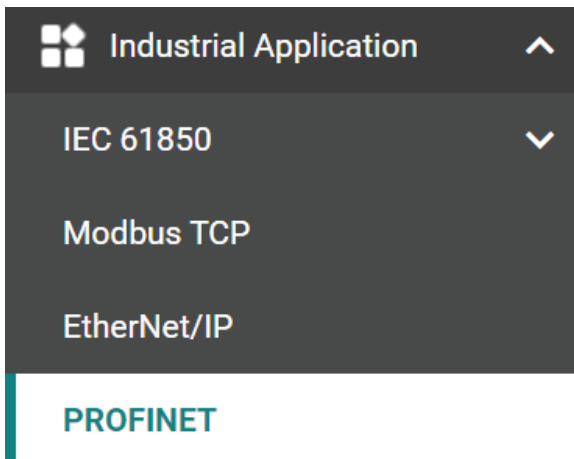

Click the **Settings** tab.

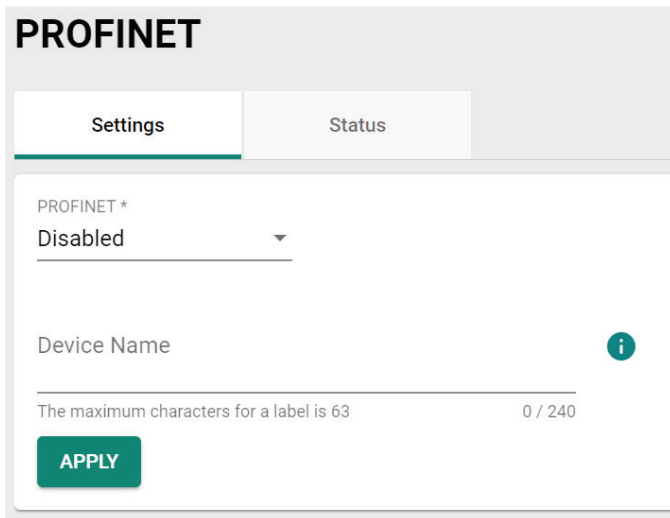

Configure the following settings:

PROFINET

Setting	Description	Factory Default
Enabled	Enable PROFINET.	Disabled
Disabled	Disable PROFINET.	

For security reasons, a confirmation prompt will appear when enabling PROFINET. Click **CONFIRM** to continue.

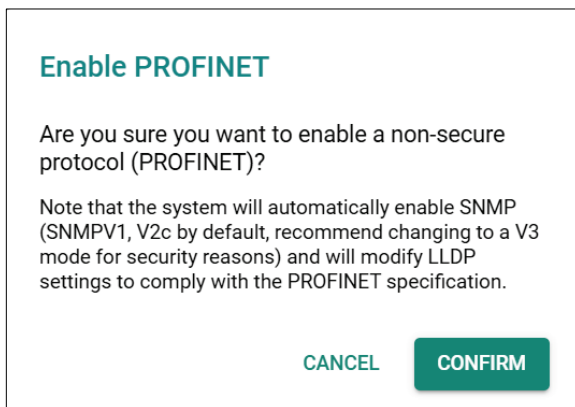

Device Name

Setting	Description	Factory Default
Max. 240 characters	<p>This represents the device label. To add multiple labels, use a period (.) to separate each label. For example, moxa.eds-g4012, where "moxa" and "eds-g4012" are separate labels. The PROFINET device name is subject to the following naming rules:</p> <ul style="list-style-type: none">- The maximum length of the device name is 240 characters.- The device name only supports the following characters: a-z, 0-9, periods (.), dashes (-)- The device name cannot be in IP address format.- The device name cannot start with "port" followed by 3 or more digits.- Each label must be between 1 to 63 characters long.- Labels cannot start or end with a period (.).- Labels cannot start or end with a dash (-).	N/A

Click **APPLY** to enable PROFINET.

EtherNet/IP

Overview

EtherNet/IP is a commercial-off-the-shelf industrial protocol based on the IEEE 802.3 combined with the TCP/IP Suite managed by ODVA association. EtherNet/IP follows the OSI model and implements Common Industrial Protocol (CIP). CIP is an object-oriented protocol and ODVA defining several communication objects in CIP. Moxa switches support a subset of these objects as a device role in EtherNet/IP ecosystem.

EtherNet/IP is widely adopted as a standard communication protocol among devices in industrial ecosystems. For example, Rockwell Automation uses EtherNet/IP as the standard protocol for their Logix controllers over Ethernet networks. Moxa switches also provide EtherNet/IP features to integrate with the Rockwell system and monitor the status of the switches and the PLCs, making the switches a part of the Rockwell system.

To configure the EtherNet/IP setting, click **EtherNet/IP** in the function menu under **Industrial Application**.

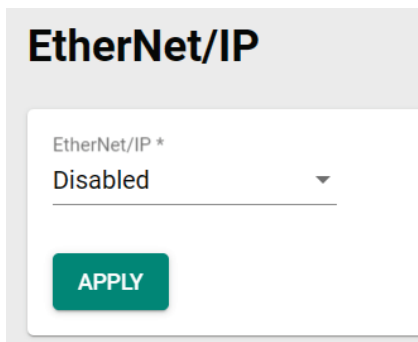
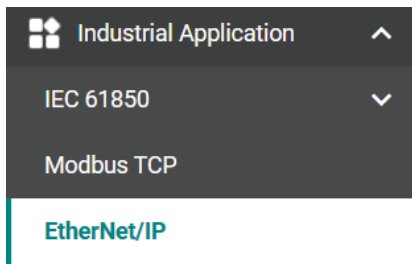

Configure the following settings:

EtherNet/IP

Setting	Description	Factory Default
Enable	Enable EtherNet/IP.	Disabled
Disable	Disable EtherNet/IP.	

When selecting **Enable**, click **CONFIRM**.

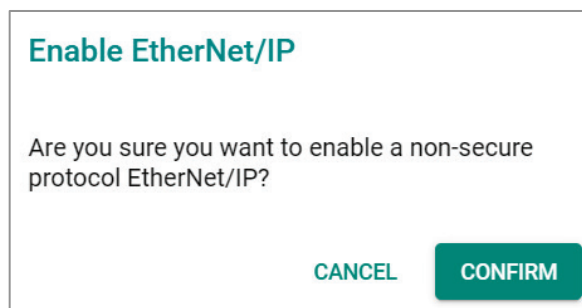

Click **APPLY** to enable EtherNet/IP.

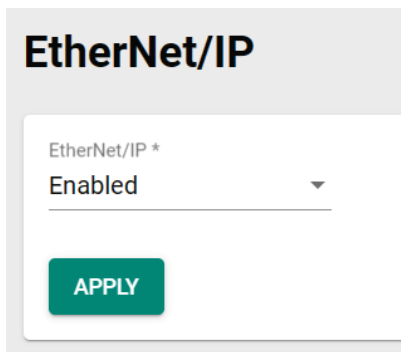

For the detailed configurations of EtherNet/IP, refer to **Appendix E**.

Maintenance and Tools

This section explains how to maintain Moxa's switch and the tools that help users operate the switch. Click the icon on the upper right corner of the page.

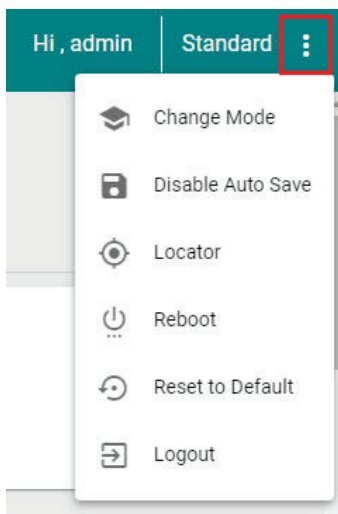

Standard/Advanced Mode

There are two configuration modes available for users: **Standard Mode** and **Advanced Mode**.

1. In **Standard Mode**, some of the features/parameters will be hidden to make it easier to perform configurations (this is the default setting).
2. In **Advanced Mode**, some advanced features/parameters will be available for users to adjust these settings.

To switch to Advanced Mode, click the change mode icon on the upper right corner of the page, and then select **Change Mode**.

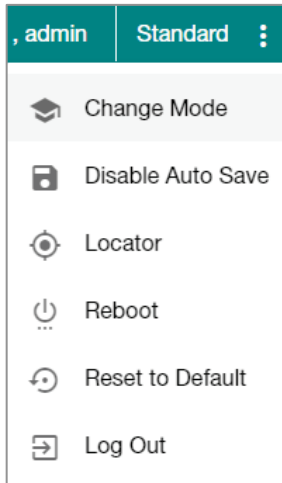

Click **CHANGE** to change to **Advanced Mode**.

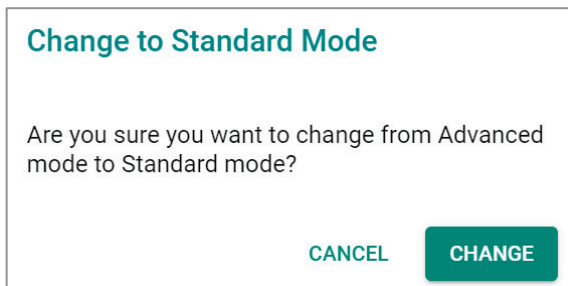

Advanced Mode offers more detailed system configurations for specific functions. Use the same process if you want to return to Standard Mode.

Disable Auto Save

Auto Save allows users to save the settings to the start-up configurations; all parameters will be effective when applied immediately, even when the switch has restarted. When users select **Disable Auto Save**, all parameters will be temporarily stored in the running config (memory), and a disk icon will appear on the upper right corner of the page. Users need to save the running-configuration to the startup-configuration when changing any parameters or function after clicking **Apply**.

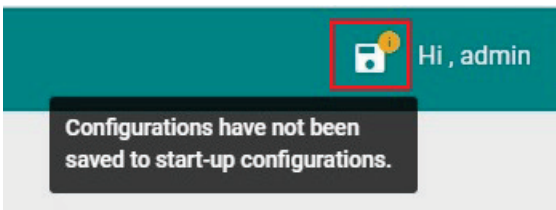

It is highly recommended that you always manually save all configurations by clicking Save Disk icon when **Disable Auto Save** is applied, or all information will have disappeared after the switch has restarted.

When **Disable Auto Save** is active, settings will not be saved on the device. Unplugging or performing a warm start will revert the switch back to the original settings. When Auto Save is enabled, all settings will be saved on the switch.

To disable the **Auto Save** function, click **Disable Auto Save** in the menu.

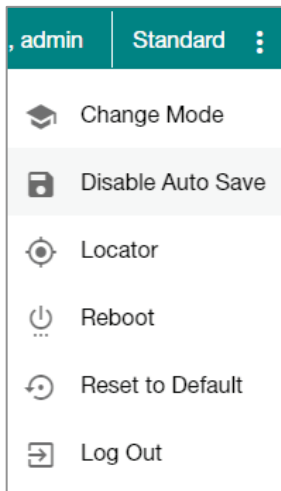

Click **Disable**.

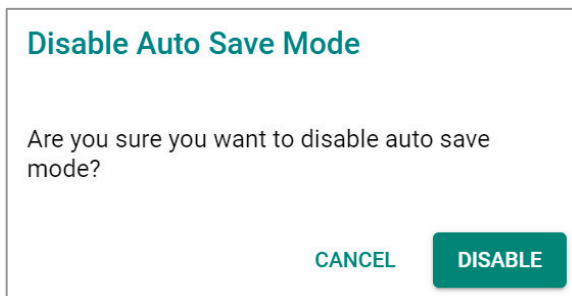

Locator

Users can trigger the device locator by clicking this icon. This will cause the LED indicators on the switch to flash for one minute. This helps users easily find the location of the switch in a field site.

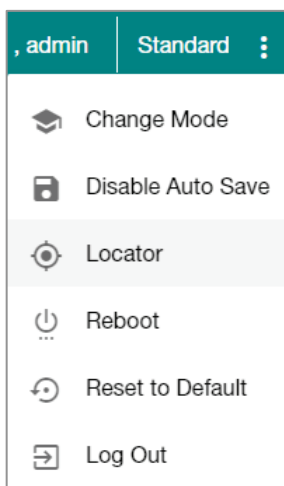

Click **Locate** to finish.

Switch Locator

Duration *

60 i

30 - 300 sec.

CANCEL **LOCATE**

Duration (sec.)

Setting	Description	Factory Default
30 to 300	Specify the length of time the indicators will remain flashing.	60

Click **Locate** to activate the switch locator. The LED indicators are located on the upper left corner of the switch as can be seen in the figure below.

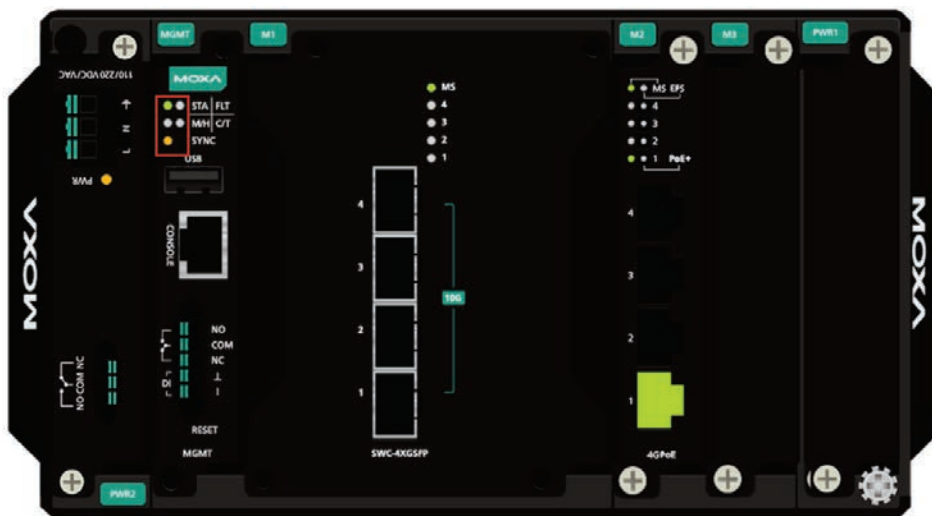

Reboot

To reboot the device, select **Reboot**.

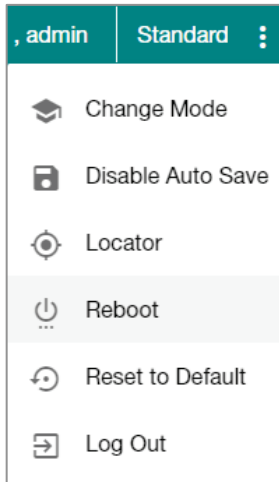

Click **REBOOT** to restart the device.

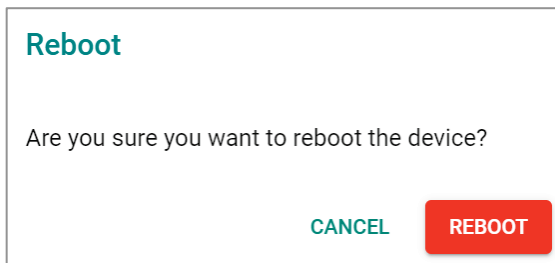

Reset to Default

To reset the switch to the default status, select **Reset to Default**.

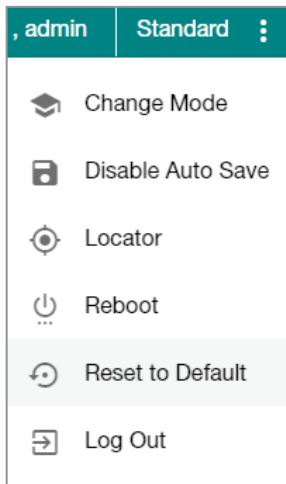

To return the switch to factory default settings, click **RESET**.

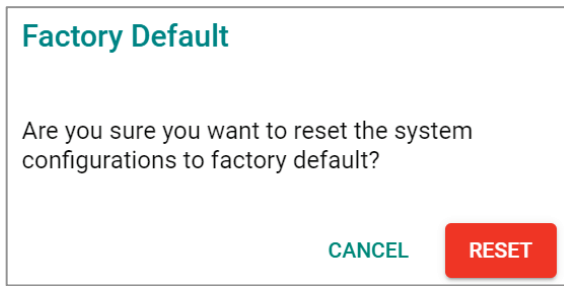

Log Out of the Switch

To log out of the switch, select **Log Out**.

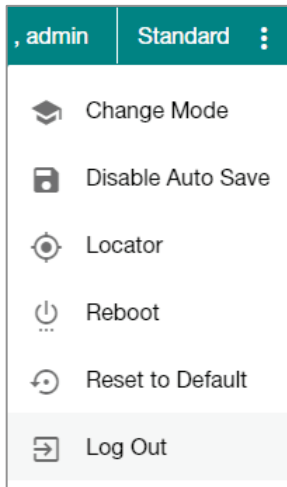

Click **LOG OUT** to log out of the switch.

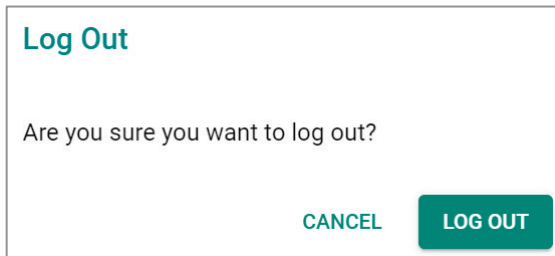

A. Account Privileges List

This appendix describes the read/write access privileges for different accounts on Moxa's Managed Ethernet Series switches.

Account Privileges List

This appendix lists the privileges for different account roles.

Please note, **R** stands for **Read** and **W** stands for **Write**.

Function	Account Privilege		
	Admin	Supervisor	User
System			
Information Setting	R/W	R/W	R
Firmware Upgrade	Execute	No Access	No Access
Configuration Backup and Restore	Execute	Execute	No Access
Event log backup	Execute	Execute	Execute
User Account	R/W	No Access	No Access
Password Policy	R/W	No Access	No Access
IP Configuration	R/W	R/W	R
DHCP Server	R/W	R/W	R
Time Zone	R/W	R/W	R
System Time	R/W	R/W	R
Port			
Port Setting	R/W	R/W	R
Linkup Delay	R/W	R/W	R
Link Aggregation (Port Channel)	R/W	R/W	R
PoE	R/W	R/W	R
VLAN			
IEEE 802.1Q	R/W	R/W	R
GARP	R/W	R/W	R
MAC			
Static Unicast	R/W	R/W	R
MAC Address Table	R/W	R/W	R
QoS			
Classification	R/W	R/W	R
Ingress Rate Limit	R/W	R/W	R
Scheduler	R/W	R/W	R
Egress Shaper	R/W	R/W	R
Multicast			
IGMP Snooping	R/W	R/W	R
Static Multicast	R/W	R/W	R
GMRP	R/W	R/W	R
Layer 2 Redundancy			
Spanning Tree	R/W	R/W	R
Turbo Ring v2	R/W	R/W	R
Turbo Chain	R/W	R/W	R
Dual Homing	R/W	R/W	R
Network Management			
SNMP	R/W	No Access	No Access
SNMP Trap/Inform	R/W	No Access	No Access
RMON1 (CLI only)	R/W	R/W	R

Function	Account Privilege		
	Admin	Supervisor	User
Security			
Management Interface	R/W	R/W	R
Login Policy	R/W	R	R
Trusted Access	R/W	R	R
SSH & SSL	Execute	Execute	No Access
IEEE802.1X	R/W	R/W	R
Port Security	R/W	R/W	R
Traffic Storm Control	R/W	R/W	R
Authentication			
RADIUS	R/W	No Access	No Access
TACACS+	R/W	No Access	No Access
Login Authentication	R/W	No Access	No Access
Diagnostics			
Event Notification	R/W	R/W	R
Relay Output	R/W	R/W	R
Email Notification	R/W	R	R
Syslog	R/W	R	R
Event Log	R/W	R/W	R
LLDP	R/W	R/W	R
Port Mirror	R/W	R/W	R
Ping	Execute	Execute	Execute
ARP Table	R/W	R/W	R
Utilization	R	R	R
Statistics	R	R	R
Module information	R	R	R
Maintenance and Tool			
Standard/Advance Mode	Execute	Execute	Execute
Disable Auto Save	R/W	R/W	R
Locator	R/W	R/W	Execute
Reboot	Execute	Execute	No Access
Reset to default	R/W	No Access	No Access

B. Event Log Description

This appendix describes all of the information for the event logs. When an event occurs, it will be recorded in the event log files. Users can check the event log name and its event log description.

Event Log Description

Event Name	Severity	Event Description
802.1X Auth Failed	Warning	802.1x authentication failed on port {{index}}/{{number}} with {{buffer}}
ABC-02 is inserted or unplugged	Notice	ABC-02 is {{inserted/unplugged}}.
ABC-03 is inserted or unplugged	Notice	ABC-03 is {{inserted/unplugged}}.
Account log out	Notice	[Account:{{user_name}}] logged out.
Account removed	Notice	[Account:{{user_name}}] has been removed by admin.
Account settings changed	Notice	Account settings of [Account:{{user_name}}] has been updated. Account settings of [Account:{{user_name}}] has been deleted. Account settings of [Account:{{user_name}}] has been created.
Announce message with different interval	Warning	An Announce message with a different interval has been received from port {{index}}/{{number}}
Announce timeout	Warning	PTP port {{index}}/{{number}} Announce receipt timer has timed out.
Check if hardware revision is valid	Notice	The hardware revision of Power Module {{index}} is not allowed.
Check if it is a known power module	Warning	To avoid potential overheating, Moxa does not recommend using a {{index}} power supply with this device.
Cold start	Critical	System has performed a cold start.
Configuration changed	Notice	Configuration {{modules}} changed by {{username}}.
Configuration exported	Notice	Configurations exported {{successful /failed}} by {{username}} via {{method}}.
Configuration imported	Notice	Configuration import {{successful /failed}} by {{username}} via {{method}}.
Coupling changed	Warning	Turbo Ring v2 coupling path status has changed.
DI off	Notice	Digital Input {{index}} has been turned off.
DI on	Notice	Digital Input {{index}} has been turned on.
DCP IP changed	Notice	IP has been changed by PROFINET DCP.
DHCP client ingress discards packets due to the DHCP Snooping rule	Warning	VLAN <vlan-id> dropped DHCP client ingress packets due to a violation of the DHCP Snooping rule. Total packets discarded: <number>
DHCP server discards packets due to the DHCP Snooping rule	Warning	VLAN <vlan-id> dropped DHCP server packets due to a violation of the DHCP Snooping rule. Total packets discarded: <number>
DIP setting failed	Notice	The DIP setting failed due to a configuration conflict.
Dual homing path changed	Warning	Dual Homing path has switched.
Event log export	Notice	Event Log export {{successful /failed}} by {{username}} via {{method}}.
Firmware upgrade failed	Warning	Firmware failed to upgrade.
Firmware upgrade successful	Notice	Firmware successfully upgraded.

Event Name	Severity	Event Description
Failed to overwrite the dhcpstp static entry	Warning	Static entry: VLAN: {{Vlan Id}}, MAC: {{mac addr}} already exists.
Fiber Check warning	Warning	Port {{index}}/{{number}} 's temperature has exceeded the threshold. Port{{index}}/{{number}} Tx power is over the threshold. Port{{index}}/{{number}} Tx power is under the threshold. Port{{index}}/{{number}} Rx power is over the threshold. Port{{index}}/{{number}} Rx power is under the threshold.
Grand Master changed	Warning	The PTP grandmaster has changed from {{mac addr}} to {{mac addr}}
Hardware revision is not allowed	Error	The hardware revision of Line Module %d is not allowed.
Interface link down	Notice	Interface{{number}} down.
Interface link up	Notice	Interface {{number}} up.
Issue event log to syslog server	Emergency	The system has lost power.
LLDP table changed	Info	LLDP remote table has changed.
Log capacity threshold	Warning	Number of event log entries {{logEntryNum}} has reached the threshold.
Log Turbo Chain Port Restart	Notice	Port-Channel {{channel id}} has restarted by Turbo Chain. Port {{index}}/{{number}} has restarted by Turbo Chain.
Login failed	Warning	[Account {{user_name}}] log in failed via {{interface}}.
Login lockout	Warning	[Account {{user_name}}] locked due to {{failed_times}} failed login attempts.
Login successful	Notice	[Account {{user_name}}] successfully logged in via {{interface}}.
Low input voltage	Warning	The input voltage of the power supply has dropped below 46 VDC. Please adjust the voltage to between 46 and 57 VDC to fit the PoE voltage requirement.
Master changed	Warning	Ring {{Index}} master has changed.
Master mismatch	Warning	Ring {{Index}} master setting does not match.
Module change	Notice	M{{index}} module has changed.
Module Initialized Fail	Error	M{{index}} Module initialized has failed.
Module inserted	Notice	M{{Index}} Module inserted.
Module removed	Notice	M{{index}} Module removed.
MSTP new port role	Warning	MSTP (MST{{Index}}) port {{number}} role changed from {{role}} to {{role}}.
MSTP root changed	Warning	MSTP (MST{{Index}}) new root has been elected in topology.
MSTP topology changed	Warning	Topology (MST{{Index}}) has been changed by MSTP.
OSPF DR router adjacency changed	Notice	Interface {{ip addr}} {{ip addr}} {{ip addr}} {{ip addr}} DR neighbor {{ip addr}} {{ip addr}} {{ip addr}} {{ip addr}} adjacency changed.
OSPF interface DR changed	Notice	Interface {{ip addr}} {{ip addr}} {{ip addr}} {{ip addr}} DR Change{{ip addr}} {{ip addr}} {{ip addr}} {{ip addr}} to {{ip addr}} {{ip addr}} {{ip addr}} {{ip addr}}.
OSPF interface ISM became DR	Notice	Interface {{ip addr}} {{ip addr}} {{ip addr}} {{ip addr}} become DR.
Packet dropped by Port Security	Warning	Port {{index}}/{{number}} dropped packets due to violation of Port Security rule.

Event Name	Severity	Event Description
Password changed	Notice	Password of [Account: {{user_name}}] has been changed.
PD no response	Error	Port {{number}} device is not responding to the PD failure check. Please check the device status.
PD over-current	Error	Current of port {{number}} has exceeded the safety limit. Please check the device status.
PD power off	Notice	Port {{number}} PD power off.
PD power on	Notice	Port {{number}} PD power on.
Port Link Down	Notice	Port {{index}}/{{number}} link down. Port-channel {{Channel id}} link down.
Port Link Up	Notice	Port {{index}}/{{number}} link up. Port-channel {{Channel id}} link up.
Port recovery by Rate Limit	Warning	Port {{index}}/{{number}} has recovered by rate limit.
Port shutdown by Loop	Critical	Port {{index}}/{{number}} looping and shutdown.
Port shutdown by Port Security	Warning	Port {{index}}/{{number}} has shut down due to a violation of the Port Security rule.
Port shutdown by Rate Limit	Warning	Port {{index}}/{{number}} has excessive traffic and shutdown.
Port state change	Info	PTP port {{index}}/{{number}} has changed from {{state}} to {{state}}.
Power budget exceeded	Warning	The consumed power {{power_value}} of all the PDs have exceeded the maximum input power {{input_power_value}}.
Power detection failure	Warning	Port {{number}} device is {{Not present/Legacy PD/802.3 af/802.3 at/802.3 bt/NIC/Unknown}}. Please {{No suggestion/enable PoE power output/disable PoE power output/select PoE output mode to High power/select PoE output mode to Force/enable legacy PD detection/raise external power supply voltage greater than 46 VDC}}.
Power module inserted	Notice	Power Module {{index}} has been inserted.
Power module removed	Notice	Power Module {{index}} has been removed.
Power Off->On	Notice	Power {{index}} has turned off.
Power On->Off	Notice	Power {{index}} has turned on.
PTP message with the wrong domain number	Warning	The PTP message with the wrong domain number was received from port {{index}}/{{number}}.
Redundant port health check failed	Error	Redundant port {{index}}/{{number}} health check fail.
Relay Override message	Notice	{{relay_name}} relay alarm has been cut off.
Relay Triggered message	Notice	{{MGMT/PWR1/PWR2}} alarm is on due to {{Event Name}}.
Resource log export	Notice	Resource Log export {{successful/failed}} by {{username}} via {{method}}.
RMON failing alarm	Warning	{{user defined}}.
RMON raising alarm	Warning	{{user defined}}.
RSTP invalid BPDU	Warning	RSTP Port-Channel {{channel id}} received an invalid BPDU (type: {{type}}, value: {{value}}). RSTP port {{index}}/{{number}} received an invalid BPDU (type: {{type}}, value: {{value}}).
RSTP migration	Warning	Port-Channel {{channel id}} changed to {{rstp/stp}}. Port {{index}}/{{number}} changed to {{rstp/stp}}.
RSTP new port role	Warning	RSTP Port-Channel {{channel id}} role changed from {{role}} to {{role}}. RSTP port {{index}}/{{number}} role changed from {{role}} to {{role}}.
RSTP root changed	Warning	RSTP new root has been elected in topology.

Event Name	Severity	Event Description
RSTP topology changed	Warning	Topology has been changed by RSTP.
Send message failed	Warning	PTP port {{index}}/{{number}} failed to transmit {{Type}}.
SSH Key generated	Notice	SSH key has been regenerated.
SSL certification changed	Notice	SSL certificate has been changed. SSL certificate has been regenerated.
Sync status changed	Warning	The PTP sync status has changed from {{PreSyncStatus}} to {{CurSyncStatus}}.
Topology changed (RSTP)	Warning	Topology has been changed by RSTP.
Topology changed (Turbo Chain)	Warning	Topology has been changed by Turbo Chain.
Topology changed (Turbo Ring)	Warning	Topology change has been detected on Ring {{RingIndex}} of Turbo Ring v2.
Topology changed (MRP)	Warning	Topology change has been detected, MRP {{strMRMState}}.
Topology changed (MSTP)	Warning	Topology (MST{{Index}}) has been changed by MSTP.
Unknown module	Warning	Module {{index}} Unknown Module Initialized Failed.
Warm start	Notice	System has performed a warm start.
Trust host moved from one port to another port (Port Security)	Warning	A trust host, MAC is {{mac address}} with VLAN {{Vlan Id}}, moved from port {{index}}/{{number}} to port {{index}}/{{number}}.

C. SNMP MIB File

This appendix contains the SNMP MIB file for the managed switch.

Standard MIB Installation Order

If you need to import the MIB one-by-one, please install the MIBs in the following order.

1. RFC1213-MIB.mib
2. SNMP-FRAMEWORK-MIB.mib
3. SNMPv2-SMI.mib
4. SNMPv2-TC.mib
5. SNMPv2-CONF.mib
6. SNMPv2-MIB.mib
7. IANAifType-MIB.mib
8. IEEE8023-LAG-MIB.mib
9. IF-MIB.mib
10. EtherLike-MIB.mib
11. IEEE8021-PAE-MIB.mib
12. BRIDGE-MIB.mib
13. P-BRIDGE-MIB.mib
14. RFC1271-MIB.mib
15. RMON-MIB.mib
16. TOKEN-RING-RMON-MIB.mib
17. RMON2-MIB.mib
18. Q-BRIDGE-MIB.mib
19. INET-ADDRESS-MIB.mib
20. IEEE8021-TC-MIB.mib
21. IEEE8021-SPANNING-TREE-MIB.mib
22. IANA-ADDRESS-FAMILY-NUMBERS-MIB.mib
23. LLDP-MIB.mib
24. LLDP-EXT-DOT1-MIB.mib
25. LLDP-EXT-DOT3-MIB.mib

MIB Tree

Refer to the following content for the MIB Tree structure.

```
iso(1)
|-std(0)-iso8802(8802)-ieee802dot1(1)-ieee802dot1mibs(1)
  |-ieee8021paeMIB(1): IEEE8021-PAE-MIB.mib
  |-ieee8021SpanningTreeMib(3): IEEE8021-SPANNING-TREE-MIB.mib
|-org(3)
  |-dod(6)-internet(1)
    |-mgmt(2)-mib-2(1): SNMPv2-MIB.mib
      |-system(1): RFC1213-MIB.mib
```

```

|-interface(2): RFC1213-MIB.mib
|-at(3): RFC1213-MIB.mib
|-snmp(11): RFC1213-MIB.mib
|-rmon(16): RMON-MIB.mib
|-dot1dBridge(17): BRIDGE-MIB.mib, P-BRIDGE-MIB.mib, Q-BRIDGE-MIB.mib
|-ifMIB(31): IF-MIB.mib
|-etherMIB(35): EtherLike-MIB.mib
|-private(4)-moxa(8691)
|-product(600): mxGeneralInfo.mib, mxProductInfo.mib,
|-general(602): mxGeneral.mib, mxDeviceIo.mib, mxDhcpSvr.mib, mxEmailC.mib,
                mxEventLog.mib,
                :mxGene.mib, mxLocator.mib, mxManagementIp.mib, mxPoe.mib,
                mxPorte.mib,
                : mxRelayC.mib, mxSnmp.mib, mxSwe.mib, mxSysLoginPolicySvr.mib,
                : mxSyslogSvr.mib, mxSysPasswordPolicySvr.mib, mxSystemInfo.mib,
                : mxSysTrustAccessSvr.mib, mxSysUtilSvr.mib, mxTimeSetting.mib,
                : mxTimeZone.mib, mxTrapC.mib, mxUiServiceMgmt.mib
|-switching(603): mxSwitching.mib
|- portInterfacce : mxPort.mib, mxLa.mib
|- basicLayer2: mxLhc.mib, mxQos, mxVlan.mib
|- layer2Redundancy: mxRstp.mib, mxTrv2.mib, mxTurboChain.mib,
                    mxDualHoming.mib
|- layer2Security: mxStcl.mib, mxRlps.mib, mxPssp.mib, mxPsms.mib, mxDot1x.mib,
                    mxRadius.mib
|- layer2Diagnostic: mxLldp.mib, mxTcst.mib, mxPortMirror.mib, mxRmon.mib
|- layer3Diagnostic
|- layer2Multicast: mxIgmpp.mib
|- layer3Multicast
|-poe(608): mxPoe.mib
|-snmpV2(6)-snmpModules(3)
|-snmpFrameworkMIB(10): SNMP-FRAMEWORK.mib
|-ieee(111)-standards-association-numbers-series-standards(2)-lan-man-stds(802)-ieee802dot1(1)-
  ieee802dot1mibs(1)-ieee8021SpanningTreeMib(3): IEEE8021-SPANNING-TREE-MIB.mib

```

D. MODBUS Data Map and Information

Interpretation of Moxa Switches

The data map addresses of Moxa switches shown in the following table start from MODBUS address 30001 for Function Code 4. For example, the address offset 0x0000 (hex) equals MODBUS address 30001, and the address offset 0x0010 (hex) equals MODBUS address 30017. Note that all the information read from Moxa switches are in hex mode. To interpret the information, refer to the ASCII table for the translation (For example, 0x4D = 'M', 0x6F = 'o').

- **System Information**

Address Offset	Data type	Interpretation	Description
0x0000	1 word	HEX	Vendor ID = 0x1393
0x0001	1 word		Unit ID (Ethernet = 1)
0x0002	2 word	HEX	Product Code (Please refer to Product Code Table)
0x0010	20 words	ASCII	Vendor Name Ex: Vendor Name = "Moxa" Word 0 Hi byte = 'M' Word 0 Lo byte = 'o' Word 1 Hi byte = 'x' Word 1 Lo byte = 'a' Word 2 Hi byte = '\0' Word 2 Lo byte = '\0'
0x0030	20 words	ASCII	Product Model EX: Product Model = "MDS-G4028" Word 0 Hi byte = 'M' Word 0 Lo byte = 'D' Word 1 Hi byte = 'S' Word 1 Lo byte = '-' Word 2 Hi byte = 'G' Word 2 Lo byte = '4' Word 3 Hi byte = '0' Word 3 Lo byte = '2' Word 4 Hi byte = '8' Word 4 Lo byte = '\0'
0x004B	6 words	ASCII	Product Serial Number
0x0051	2 words	HEX	Firmware Version Word 0 Hi byte = major (A) Word 0 Lo byte = minor (B) Word 1 Hi byte = release (C) Word 1 Lo byte = build (D)
0x0053	2 words	HEX	Firmware Build Date For example: Word 0 = 0 x 0609 Word 1 = 0 x 0705 Firmware was built on 2007-05-06 at 09 o'clock

Address Offset	Data type	Interpretation	Description
0x0055	3 words	HEX	Ethernet MAC Address Ex: MAC = 00-01-02-03-04-05 Word 0 Hi byte = 0 x 00 Word 0 Lo byte = 0 x 01 Word 1 Hi byte = 0 x 02 Word 1 Lo byte = 0 x 03 Word 2 Hi byte = 0 x 0 Word 2 Lo byte = 0 x 05
0x0058	1 word	HEX	Power 1 0x0000: Off 0x0001: ON
0x0059	1 word	HEX	Power 2 0x0000: Off 0x0001: On
0x005A	1 word	HEX	Fault LED Status 0x0000: No 0x0001: Yes
0x0080	1 word	HEX	DI1 0x0000:Off 0x0001:On 0xFFFE: DI1 is Not Supported
0x0081	1 word	HEX	DI2 0x0000:Off 0x0001:On 0xFFFE: DI2 is Not Supported
0x0082	1 word	HEX	DO1 0x0000:Off 0x0001:On 0xFFFE: DO1 is Not Supported
0x0083	1 word	HEX	DO2 0x0000:Off 0x0001:On 0xFFFE: DO2 is Not Supported
0x0084	1 word	HEX	DO3 0x0000:Off 0x0001:On 0xFFFE: DO3 is Not Supported
0x0085 (Power Module 1) 0x0086 (Power Module 2)	1 word	HEX	Power Module Present 0x0000: Not Present 0x0001: Present 0xFFFE: Power Module is Not Supported
0x0087 (Power Module 1) 0x0097 (Power Module 2)	16 words	ASCII	Power Module Name EX: "PWR-HV-P48" Word 0 Hi byte = 'P' Word 0 Lo byte = 'W' Word 1 Hi byte = 'R' Word 1 Lo byte = '-' Word 2 Hi byte = 'H' Word 2 Lo byte = 'V' Word 3 Hi byte = '-' Word 3 Lo byte = 'P' Word 4 Hi byte = '4' Word 4 Lo byte = '8' Word 5 Hi byte = '\n' Word 5 Lo byte = '\n'
0x00A7 (Power Module 1) 0x00AD (Power Module 2)	6 words	ASCII	Power Module Serial Number

Address Offset	Data type	Interpretation	Description
0x00B3 (Power Module 1) 0x00B5 (Power Module 2)	2 words	HEX	Power Module Product Revision Word 0 Hi byte = major (A) Word 0 Lo byte = subversion (B) Word 1 Hi byte = minor (C) Word 1 Lo byte = 0
0x00B7 (External Module 1) 0x00B8 (External Module 2) ...	1 word	HEX	External Module Present 0x0000: Not Present 0x0001: Present 0xFFFE: External Module is Not Supported
0x00C7 (External Module 1) 0x00D7 (External Module 2) ...	16 words	ASCII	External Module Name EX: "LM-7000H-4GTX" Word 0 Hi byte = 'L' Word 0 Lo byte = 'M' Word 1 Hi byte = '-' Word 1 Lo byte = '7' Word 2 Hi byte = '0' Word 2 Lo byte = '0' Word 3 Hi byte = '0' Word 3 Lo byte = 'H' Word 4 Hi byte = '-' Word 4 Lo byte = '4' Word 5 Hi byte = 'G' Word 5 Lo byte = 'T' Word 6 Hi byte = 'X' Word 6 Lo byte = '\n'
0x01C7 (External Module 1) 0x01CD (External Module 2) ...	6 words	ASCII	External Module Serial Number
0x0227 (External Module 1) 0x0229 (External Module 2) ...	2 words	HEX	External Module Product Revision Word 0 Hi byte = major (A) Word 0 Lo byte = subversion (B) Word 1 Hi byte = minor (C) Word 1 Lo byte = 0

• **Port Information**

Address Offset	Data type	Interpretation	Description
0x1000 (Port 1) 0x1001 (Port 2) ... Maximum Port (n) 0x1000 + n (Channel Group 1) 0x1000 + n + 1 (Channel Group 2) ...	1 word	HEX	Port Status 0x0000: Link down 0x0001: Link up 0x0002: Disable 0xFFFF: No port
0x1100 (Port 1) 0x1101 (Port 2) ... Maximum Port (n) 0x1100 + n (Channel Group 1) 0x1100 + n + 1 (Channel Group 2) ...	1 word	HEX	Port Speed (Y: Channel group active port count) 0x0000: 10M-Half 0xY001: 10M-Full 0x0002: 100M-Half 0xY003: 100M-Full 0xY004: 1G-Full 0xY005: 2500M-Full 0xY006: 10G-Full 0xY007: 40G-Full 0xY008: 50G-Full 0xY009: 25G-Full 0xY00A: 100G-Full 0xFFFE: Inactive Link 0xFFFF: No port
0x1200 (Port 1) 0x1201 (Port 2) ... Maximum Port (n)	1 word	HEX	Port Flow Ctrl 0x0000: Off 0x0001: On 0xFFFE: Inactive Link 0xFFFF: No port
0x1300 (Port 1) 0x1301 (Port 2) ... Maximum Port (n)	1 word	HEX	Port MDI/MDIX 0x0000: MDI 0x0001: MDIX 0xFFFD: Fiber Port 0xFFFE: Inactive Link 0xFFFF: No port
0x1400 (Port 1) 0x1420 (Port 2) ... Maximum Port (n)	32 words	ASCII	Port Media Type Ex: Port 1 Media Type = "100TX,RJ45." Word 0 Hi byte = '1' Word 0 Lo byte = '0' Word 1 Hi byte = '0' Word 1 Lo byte = 'T' ... Word 4 Hi byte = '4' Word 4 Lo byte = '5' Word 5 Hi byte = ',' Word 5 Lo byte = '\0'

• **Packet Information**

Address Offset	Data type	Interpretation	Description
0x2000 (Port 1) 0x2002 (Port 2) ... Maximum Port (n) 0x2000 + (n * 2) (Channel Group 1) 0x2000 + ((n + 1) * 2) (Channel Group 2) ...	2 words	HEX	Port Tx Packets Ex: port 1 Tx Packet Amount = 44332211 Received MODBUS response: 0x02A474B3 Word 0 = 0x02A4 Word 1 = 0x74B3
0x2100 (Port 1) 0x2102 (Port 2) ... Maximum Port (n) 0x2100 + (n * 2) (Channel Group 1) 0x2100 + ((n + 1) * 2) (Channel Group 2) ...	2 words	HEX	Port Rx Packets Ex: port 1 Tx Packet Amount = 44332211 Received MODBUS response: 0x02A474B3 Word 0 = 0x02A4 Word 1 = 0x74B3
0x2200 (Port 1) 0x2202 (Port 2) ... Maximum Port (n) 0x2200 + (n * 2) (Channel Group 1) 0x2200 + ((n + 1) * 2) (Channel Group 2) ...	2 words	HEX	Port Tx Error Packets Ex: port 1 Tx Packet Amount = 44332211 Received MODBUS response: 0x02A474B3 Word 0 = 0x02A4 Word 1 = 0x74B3
0x2300 (Port 1) 0x2302 (Port 2) ... Maximum Port (n) 0x2300 + (n * 2) (Channel Group 1) 0x2300 + ((n + 1) * 2) (Channel Group 2) ...	2 words	HEX	Port Rx Error Packets Ex: port 1 Tx Packet Amount = 44332211 Received MODBUS response: 0x02A474B3 Word 0 = 0x02A4 Word 1 = 0x74B3

• **Redundancy Information**

Address Offset	Data type	Interpretation	Description
0x3000	1 word	HEX	Redundancy Protocol 0x0000: None 0x0001: RSTP 0x0002: Turbo Ring V2 0x0003: Turbo Chain 0x0004: Dual Homing 0x0005: RSTP & Dual Homing 0x0006: Turbo Ring V2 & Dual Homing 0x0007: Turbo Chain & Dual Homing
0x3100	1 word	HEX	RSTP Root 0x0000: Not Root 0x0001: Root 0xFFFE: RSTP is Not Supported 0xFFFF: RSTP is Not Enabled
0x3200 (Port 1) 0x2301 (Port 2) ... Maximum Port (n) 0x3200 + n (Channel Group 1) 0x3200 + n + 1 (Channel Group 2) ...	1 word	HEX	RSTP Port Status 0x0000: Port Disabled 0x0001: Not RSTP Port 0x0002: Link Down 0x0003: Blocked 0x0004: Learning 0x0005: Forwarding 0xFFFD: No Port 0xFFFE: RSTP is Not Supported 0xFFFF: RSTP is Not Enabled
0x3500	1 word	HEX	Turbo Ring V2 Coupling Mode 0x0000: None 0x0001: Coupling Backup 0x0002: Coupling Primary 0xFFFE: Turbo Ring V2 is Not Supported 0xFFFF: Turbo Ring V2 is Not Enabled
0x3501	1 word	HEX	Turbo Ring V2 Coupling Port Primary Status 0x0000: Not Coupling Port 0x0001: Link Down 0x0002: Blocked 0x0003: Learning 0x0004: Forwarding 0xFFFD: Turbo Ring V2 Coupling is Not Enabled 0xFFFE: Turbo Ring V2 is Not Supported 0xFFFF: Turbo Ring V2 is Not Enabled
0x3502	1 word	HEX	Turbo Ring V2 Coupling Port Backup Status 0x0000: Not Coupling Port 0x0001: Link Down 0x0002: Blocked 0x0003: Learning 0x0004: Forwarding 0xFFFD: Turbo Ring V2 Coupling is Not Enabled 0xFFFE: Turbo Ring V2 is Not Supported 0xFFFF: Turbo Ring V2 is Not Enabled
0x3600	1 word	HEX	Turbo Ring V2 Ring 1 Status 0x0000: Healthy 0x0001: Break 0xFFFD: Turbo Ring V2 Ring 1 is Not Enabled 0xFFFE: Turbo Ring V2 is Not Supported 0xFFFF: Turbo Ring V2 is Not Enabled

Address Offset	Data type	Interpretation	Description
0x3601	1 word	HEX	Turbo Ring V2 Ring 1 Master/Slave 0x0000: Slave 0x0001: Master 0xFFFF: Turbo Ring V2 Ring 1 is Not Enabled 0xFFFE: Turbo Ring V2 is Not Supported 0xFFFF: Turbo Ring V2 is Not Enabled
0x3602	1 word	HEX	Turbo Ring V2 Ring 1's 1st Port Status 0x0000: Link Down 0x0001: Blocked 0x0002: Learning 0x0003: Forwarding 0xFFFF: Turbo Ring V2 Ring 1 is Not Enabled 0xFFFE: Turbo Ring V2 is Not Supported 0xFFFF: Turbo Ring V2 is Not Enabled
0x3603	1 word	HEX	Turbo Ring V2 Ring 1's 2nd Port Status 0x0000: Link Down 0x0001: Blocked 0x0002: Learning 0x0003: Forwarding 0xFFFF: Turbo Ring V2 Ring 1 is Not Enabled 0xFFFE: Turbo Ring V2 is Not Supported 0xFFFF: Turbo Ring V2 is Not Enabled
0x3680	1 word	HEX	Turbo Ring V2 Ring 2 Status 0x0000: Healthy 0x0001: Break 0xFFFF: Turbo Ring V2 Ring 2 is Not Enabled 0xFFFE: Turbo Ring V2 is Not Supported 0xFFFF: Turbo Ring V2 is Not Enabled
0x3681	1 word	HEX	Turbo Ring V2 Ring 2 Master/Slave 0x0000: Slave 0x0001: Master 0xFFFF: Turbo Ring V2 Ring 2 is Not Enabled 0xFFFE: Turbo Ring V2 is Not Supported 0xFFFF: Turbo Ring V2 is Not Enabled
0x3682	1 word	HEX	Turbo Ring V2 Ring 2's 1st Port Status 0x0000: Link Down 0x0001: Blocked 0x0002: Learning 0x0003: Forwarding 0xFFFF: Turbo Ring V2 Ring 2 is Not Enabled 0xFFFE: Turbo Ring V2 is Not Supported 0xFFFF: Turbo Ring V2 is Not Enabled
0x3683	1 word	HEX	Turbo Ring V2 Ring 2's 2nd Port Status 0x0000: Link Down 0x0001: Blocked 0x0002: Learning 0x0003: Forwarding 0xFFFF: Turbo Ring V2 Ring 2 is Not Enabled 0xFFFE: Turbo Ring V2 is Not Supported 0xFFFF: Turbo Ring V2 is Not Enabled
0x3700	1 word	HEX	Turbo Chain Switch Role 0x0000: Head 0x0001: Member 0x0002: Tail 0xFFFE: Turbo Chain is Not Supported 0xFFFF: Turbo Chain is Not Enabled

Address Offset	Data type	Interpretation	Description
0x3701	1 word	HEX	Turbo Chain 1st Port Status 0x0000: Link Down 0x0001: Blocked 0x0002: Listening 0x0003: Forwarding 0xFFFE: Turbo Chain is Not Supported 0xFFFF: Turbo Chain is Not Enabled
0x3702	1 word	HEX	Turbo Chain 2nd Port Status 0x0000: Link Down 0x0001: Blocked 0x0002: Listening 0x0003: Forwarding 0xFFFE: Turbo Chain is Not Supported 0xFFFF: Turbo Chain is Not Enabled
0x3800	1 word	HEX	Dual Homing Primary Link Status 0x0000: Link Down 0x0001: Link Up 0xFFFE: Dual Homing is Not Supported 0xFFFF: Dual Homing is Not Enabled
0x3801	1 word	HEX	Dual Homing Primary Port State 0x0000: Link Down 0x0001: Blocking 0x0002: Forwarding 0xFFFE: Dual Homing is Not Supported 0xFFFF: Dual Homing is Not Enabled
0x3802	1 word	HEX	Dual Homing Secondary Link Status 0x0000: Link Down 0x0001: Link Up 0xFFFE: Dual Homing is Not Supported 0xFFFF: Dual Homing is Not Enabled
0x3803	1 word	HEX	Dual Homing Secondary Port Status 0x0000: Link Down 0x0001: Blocking 0x0002: Forwarding 0xFFFE: Dual Homing is Not Supported 0xFFFF: Dual Homing is Not Enabled
0x3804	1 word	HEX	Dual Homing Path Switching Mode 0x0000: Primary path always first 0x0001: Maintain current path 0xFFFE: Dual Homing is Not Supported 0xFFFF: Dual Homing is Not Enabled

E. PROFINET Attributes and TIA Portal Integration

Addressing of I/O Data in PROFINET I/O Based on Slot and Sub-Slots

The concept of the Moxa PROFINET switch is shown in the table below. In this structure, each switch port represents one sub-slot.

Slot 0						
Sub Slot 0		Sub Slot 0X8000	Sub Slot 0X8001	Sub Slot 0X8002	Sub Slot 0X8003	...
DAP		IO Data	Port 1	Port 2	Port 3	

Manufacturer Information

Each PROFINET device is addressed based on a MAC address. This address is unique worldwide. The company code (bits 47 to 24) can be obtained from the IEEE Standards Department free of charge. This part is called the OUI (organizationally unique identifier).

Table. MOXA OUI

Bit Value 47..24						Bit Value 23..0					
0	0	0	2	2	9	x	x	x	x	x	x
Company Code (OUI)						Consecutive Number					

PROFINET Attributes

Combined with the General Station Description (GSD) file, an IO-Controller can quickly configure settings for different devices and seamlessly replace devices. A PROFINET IO General Station Description (GSD) file is a description of an IO-Device provided by the device manufacturer. The contents of the GSD file contain configuration information, parameters, modules, diagnostics and alarms, and vendor and device identification.

PROFINET Cyclic I/O Data

The Moxa PROFINET switch provides PROFINET I/O cyclic data and includes the following items:

PROFINET Cyclic I/O Data Table

Device Status

Category	Direction	Byte	Bit	Name	Description
Device	Input	0	0	Device status	0 is failed status, 1 is OK.
			1	Power 1	0 is unavailable, 1 is OK
			2	Power 2	0 is unavailable, 1 is OK
Device	Input	1		Reserved for redundancy protocol	

Port Status

Category	Direction	Byte	Bit	Name	Description
Port	Input	0	0	Port 1 Connection	0 is not connected, 1 is connected
			1	Port 2 Connection	0 is not connected, 1 is connected
			2	Port 3 Connection	0 is not connected, 1 is connected
			[...]	[...]	[...]
		1	1	Port 9 connection	0 is not connected, 1 is connected
			2	Port 10 connection	0 is not connected, 1 is connected
			[...]	[...]	[...]
			7	Port 64 connection	0 is not connected, 1 is connected
Port	Input	8	0	Port channel 1 Connection	0 is not connected, 1 is connected
			1	Port channel 2 Connection	0 is not connected, 1 is connected
		[...]	[...]	[...]	[...]
		11	7	Port channel 32 Connection	0 is not connected, 1 is connected

You can monitor these attributes in TIA Portal. Operation steps are in the Chapter “Monitoring the Switch”
Monitor Device I/O Cyclic Data and Port I/O Cyclic Data in TIA Portal.

The screenshot shows a TIA Portal Watch table for PLC_1 [CPU 1513-1 PN]. The table lists cyclic data for various ports and device status. The columns are Name, Address, Display format, Monitor value, Modify value, Comment, and Tag comment. The monitor values are displayed as TRUE or FALSE with checkboxes.

Name	Address	Display format	Monitor value	Modify value	Comment	Tag comment
Cyclic Data - Device Status - All	%I80	Hex	16#03	<input type="checkbox"/>		
Cyclic Data - Device Status	%I0.0	Bool	TRUE	<input type="checkbox"/>		
Cyclic Data - Power 1	%I0.1	Bool	TRUE	<input type="checkbox"/>		
Cyclic Data - Power 2	%I0.2	Bool	FALSE	<input type="checkbox"/>		
Cyclic Data - Port Status - All	%IW2	Hex	16#4030	<input type="checkbox"/>		
Cyclic Data - Port 1	%I2.0	Bool	FALSE	<input type="checkbox"/>		
Cyclic Data - Port 2	%I2.1	Bool	FALSE	<input type="checkbox"/>		
Cyclic Data - Port 3	%I2.2	Bool	FALSE	<input type="checkbox"/>		
Cyclic Data - Port 4	%I2.3	Bool	FALSE	<input type="checkbox"/>		
Cyclic Data - Port 5	%I2.4	Bool	FALSE	<input type="checkbox"/>		
Cyclic Data - Port 6	%I2.5	Bool	FALSE	<input type="checkbox"/>		
Cyclic Data - Port 7	%I2.6	Bool	TRUE	<input type="checkbox"/>		
Cyclic Data - Port 8	%I2.7	Bool	FALSE	<input type="checkbox"/>		
Cyclic Data - Port 9	%I3.0	Bool	FALSE	<input type="checkbox"/>		
Cyclic Data - Port 10	%I3.1	Bool	FALSE	<input type="checkbox"/>		
Cyclic Data - Port 11	%I3.2	Bool	FALSE	<input type="checkbox"/>		
Cyclic Data - Port 12	%I3.3	Bool	FALSE	<input type="checkbox"/>		
Cyclic Data - Port 13	%I3.4	Bool	TRUE	<input type="checkbox"/>		
Cyclic Data - Port 14	%I3.5	Bool	TRUE	<input type="checkbox"/>		

PROFINET I/O Parameters

Moxa defines comprehensive PROFINET I/O parameters for more flexible settings and monitoring. The attributes are readable or writable. PROFINET I/O parameters use PROFINET acyclic data to achieve communication in the network. You can use the TIA Portal tool or engineering deployment software to edit it. There are 2 categories of parameters, including Device Status and Device Alarms. The following tables provide parameter information:

- **r/w:** Read and Write
- **ro:** Read Only

Device Status

Byte	Name	Access	Value	Description
0	PLC Connection Status	ro	0	Unavailable
			1	Connection failure
			2	OK
1	Fault Status	ro	0	Unavailable
			1	Device detect fault
			2	OK
2	Power 1 Status	ro	0	Unavailable
			1	Power 1 fails
			2	OK
3	Power 2 Status	ro	0	Unavailable
			1	Power 2 fails
			2	OK
4	DI 1 Status	ro	0	Unavailable
			1	Closed
			2	Open
5	DI 2 Status	ro	0	Unavailable
			1	Closed
			2	Open
6	Spanning Tree Config	ro	0	Unavailable
			1	Disable
			2	RSTP
			3	MSTP
7	Turbo Ring v2 Config	ro	0	Unavailable
			1	Disable
			2	Enable
8	Turbo Ring v2 Ring 1 Config	ro	0	Unavailable
			1	Disable
			2	Enable
9	Turbo Ring v2 Ring 1 Status	ro	0	Unavailable
			1	Disable
			2	Broken
			3	Healthy
10	Turbo Ring v2 Ring 2 Config	ro	0	Unavailable
			1	Disable
			2	Enable
11	Turbo Ring v2 Ring 2 Status	ro	0	Unavailable
			1	Disable
			2	Broken
			3	Healthy
12	Turbo Chain Config	ro	0	Unavailable
			1	Disable
			2	Head
			3	Member
			4	Tail
13	Dual Homing Config	ro	0	Unavailable
			1	Disable
			2	Primary path always first

Byte	Name	Access	Value	Description
14	Media Redundancy Protocol Config	ro	3	Maintain current path
			0	Unavailable
			1	Disable
			2	Enable
15	Media Redundancy Protocol Manager Status	ro	0	Unavailable
			1	Disable
			2	Initiation
			3	Awaiting Connection
			4	Primary Ring Port Link Up
			5	Ring Open
16	Media Redundancy Protocol Client Status	ro	6	Ring Closed
			0	Unavailable
			1	Disable
			2	Initiation
			3	Awaiting Connection
			4	Data Exchange Idle
			5	Pass Through
6	Data Exchange			
			7	Pass Through Idle

Device Alarms

These parameters control PROFINET Alarm functions. PROFINET Alarm is a message which sends from switch to PLC immediately once the event is triggered.

Byte	Name	Access	Value	Description	Default Value
0	Status Alarm	rw	0	Do not send any alarms	0: No alarms
			1	Send alarm if any status change	
1	Power Alarm 1	rw	0	Do not send power failed alarm	0: No alarms
			1	Send alarm if power supply 1 fails	
2	Power Alarm 2	rw	0	Do not send power failed alarm	0: No alarms
			1	Send alarm if power supply 2 fails	
3	RSTP Topology Changed Alarm	rw	0	Do not send RSTP topology changed alarm	0: No alarms
			1	Send alarm if RSTP topology changed	
4	MSTP Topology Changed Alarm	rw	0	Do not send MSTP topology changed alarm	0: No alarms
			1	Send alarm if MSTP topology changed	
5	Turbo Ring V2 Ring Broken	rw	0	Do not send TR2 broken alarm	0: No alarms
			1	Send alarm if TR2 is broken	

Reset to Factory Mode

The following table is the list of Reset to Factory Modes supported by Moxa:

Reset to Factory Mode	Description	Data Reset Details
Mode 0 - Factory Default	Original factory reset	Clear all configurations including PROFINET
Mode 1	Reset application data	Reset I&M data and the alarm configuration of the device and ports
Mode 2	Reset communication parameters	Reset the Device Name to " " and the device IP to 0.0.0.0

TIA Portal Integration

Overview of Operation Procedure

The following steps show how to integrate the switch into a PROFINET network:

1. **Enable PROFINET on the switch**

Enable PROFINET in switch web UI or by CLI commands.

2. **Create a PROFINET project in TIA Portal**

Create a PROFINET Ethernet project for deploying the environment.

Note: The examples provided in this user manual were created using TIA Portal V17. We highly recommend using the same or a later version of TIA Portal to more accurately execute the instructions in the examples.

3. **GSD file installation**

Import the Moxa switch GSD into the project.

4. **Device configuration**

Search and discover the switch in TIA Portal. Configure PROFINET attributes such as IP address, device name and I/O parameters.

5. **Save and load the project into the PLC**

Load this project into the PLC.

6. **Monitoring the Switch**

Use TIA Portal to monitor switch attributes.

Create a PROFINET Project in TIA Portal

In TIA Portal, click **Start > Create new project**.

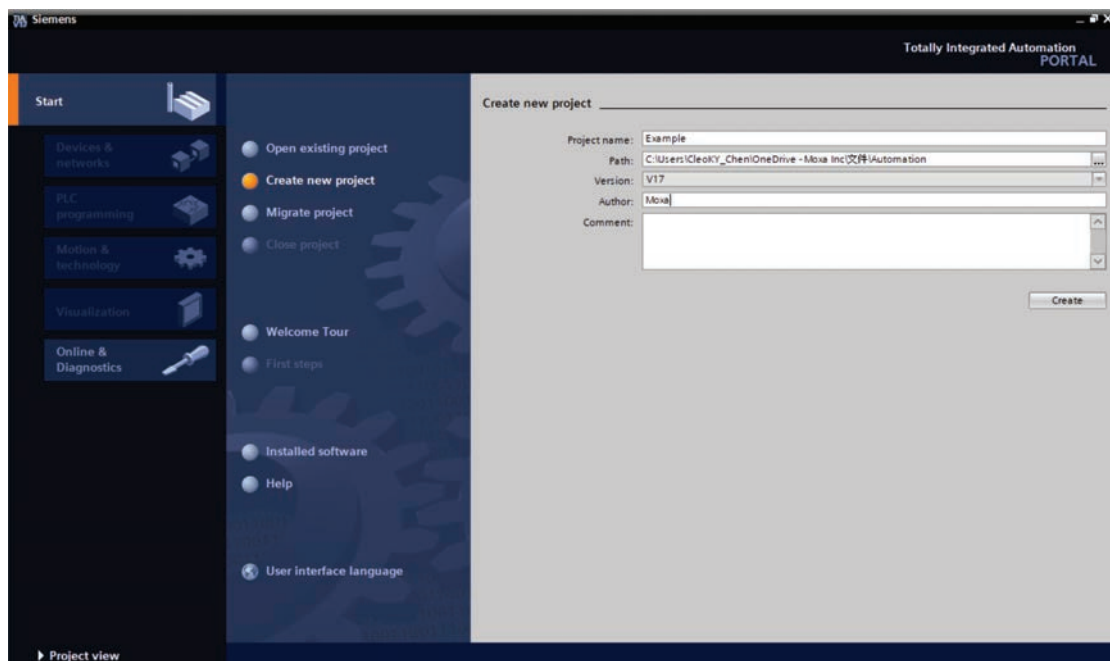

Fill in the required project information and click **Create**.

GSD File Installation

1. Download the GSD file from the Moxa website.
2. In TIA Portal, open your project and go to **Options > Manage general station description files (GSD)** in the toolbar.
3. Navigate to the folder on your PC containing the GSD files.
4. Select the GSD files to install.
5. Click **Install**.

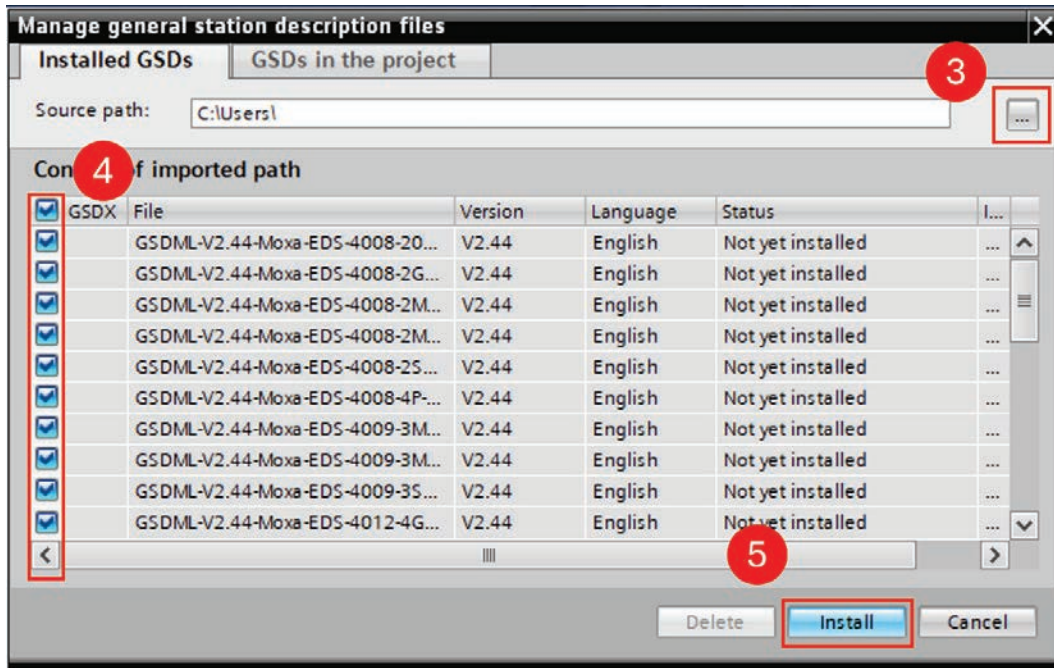

6. After installing the GSD files, click **Device & networks** in the **Devices** tab. All installed GSD files will be shown on the right.

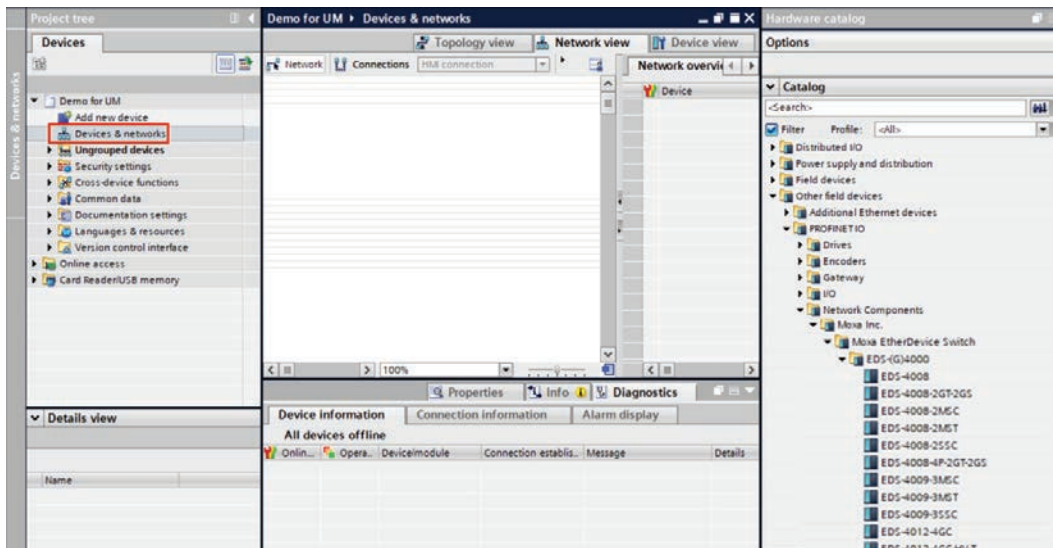

➤ Product Icons

Product models are represented by the following icons:

EDS-4009-3MSC

EDS-4012-4GC

EDS-G4008

EDS-G4014-6QGS



Device Configuration

1. In the **Devices** tab, click **Add new device**.
2. Select the PLC model and version.
In this example, we select the CPU1513-1 PN 6ES7 513-1AL01-0AB0 V2.5.
3. Click **OK**.

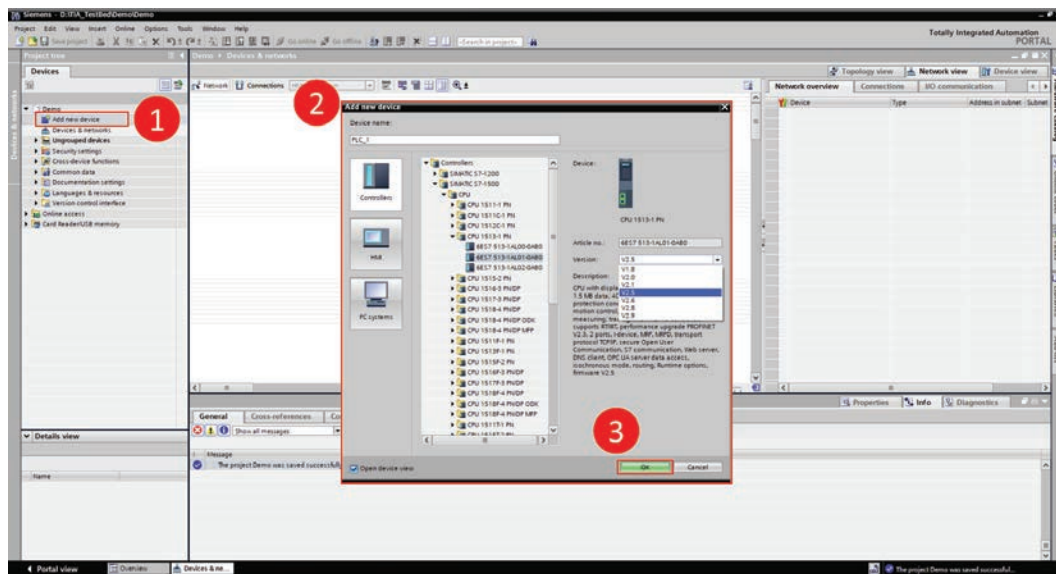

4. In the **Devices** tab, click **Device & networks** and select the switch you want to add from the **Hardware catalog** section.

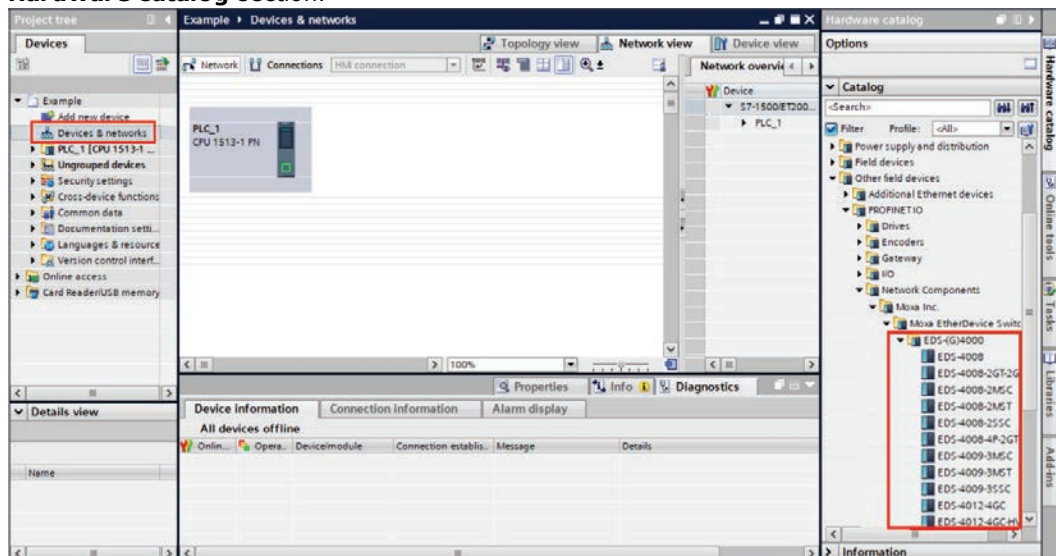

5. Click **Not assigned** on the switch and select the target to connect it to.
In this example, we connect to PLC_1.PROFINET interface_1.

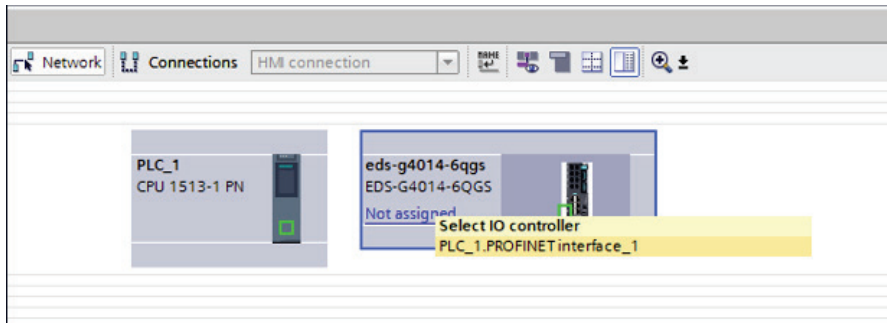

The switch and PLC will be connected.
In network view:

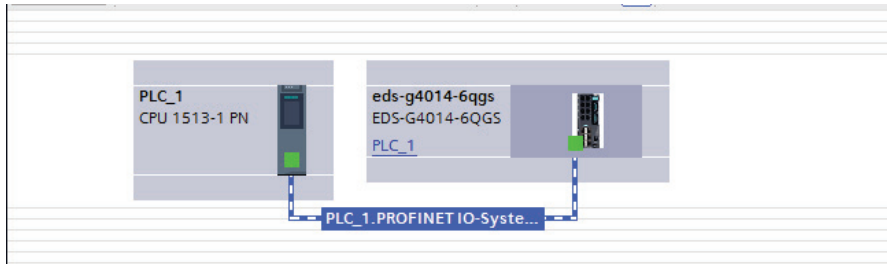

In Topology view:

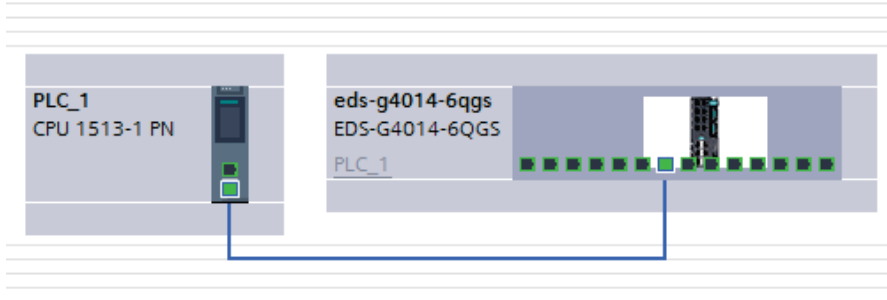

- Depending on the desired topology, configure the device(s) by right-clicking the relevant device and clicking **Properties**.

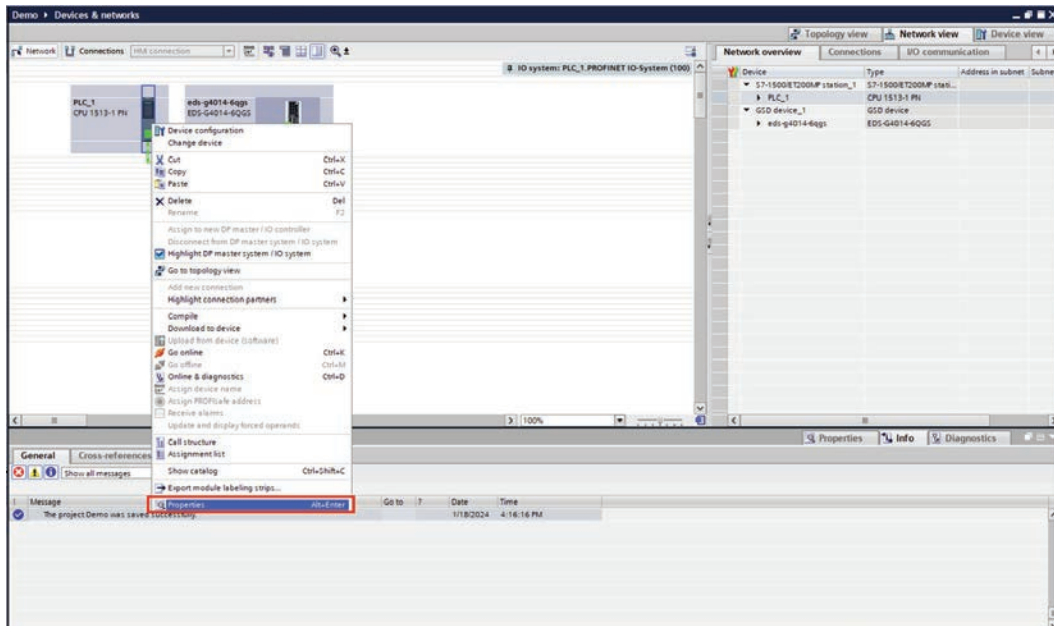

- Configure the device's IP and subnet.
The default IP address is 192.168.127.x with x representing the order of devices.

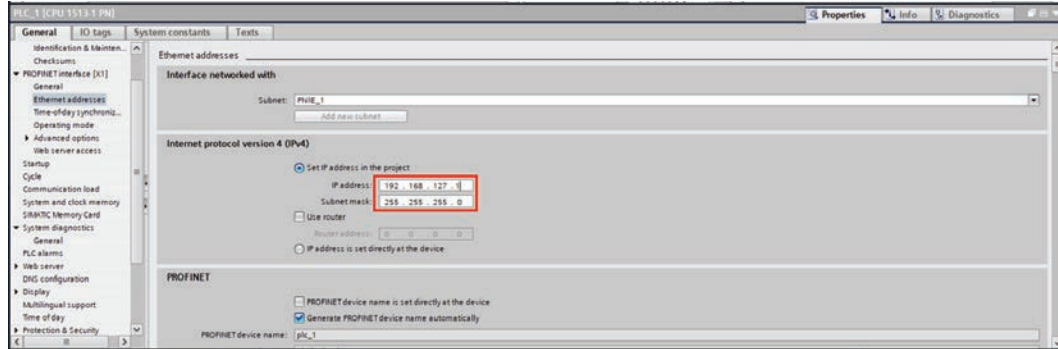

- (Optional) Right-click a device and click **Assign device name** to rename the device.

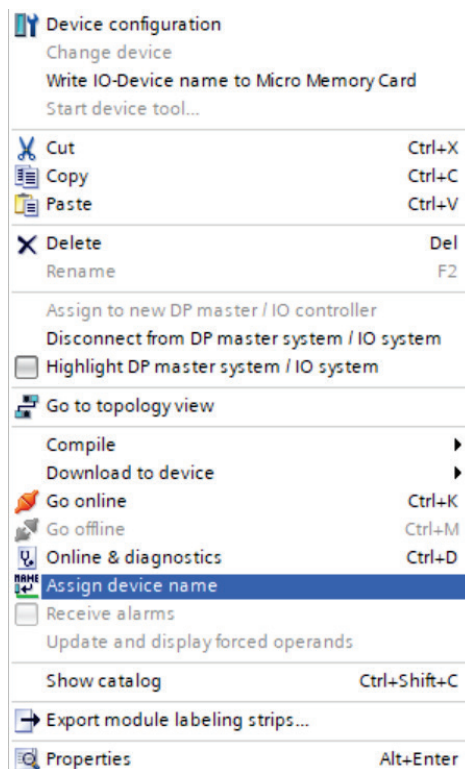

Save and Load the Project into the PLC

- In the **Devices** tab, click **Default tag table**.
- Click the Name field to rename the data field (optional) and add the information you want to monitor.

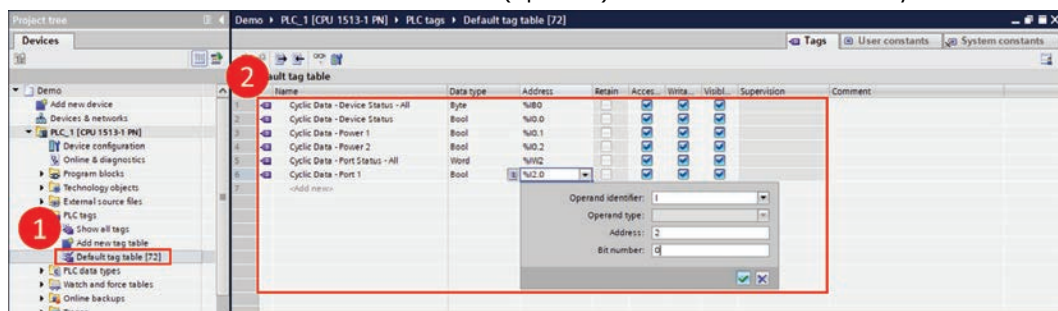

- Click **Compile** in the toolbar. The compiling process will be shown at the bottom.

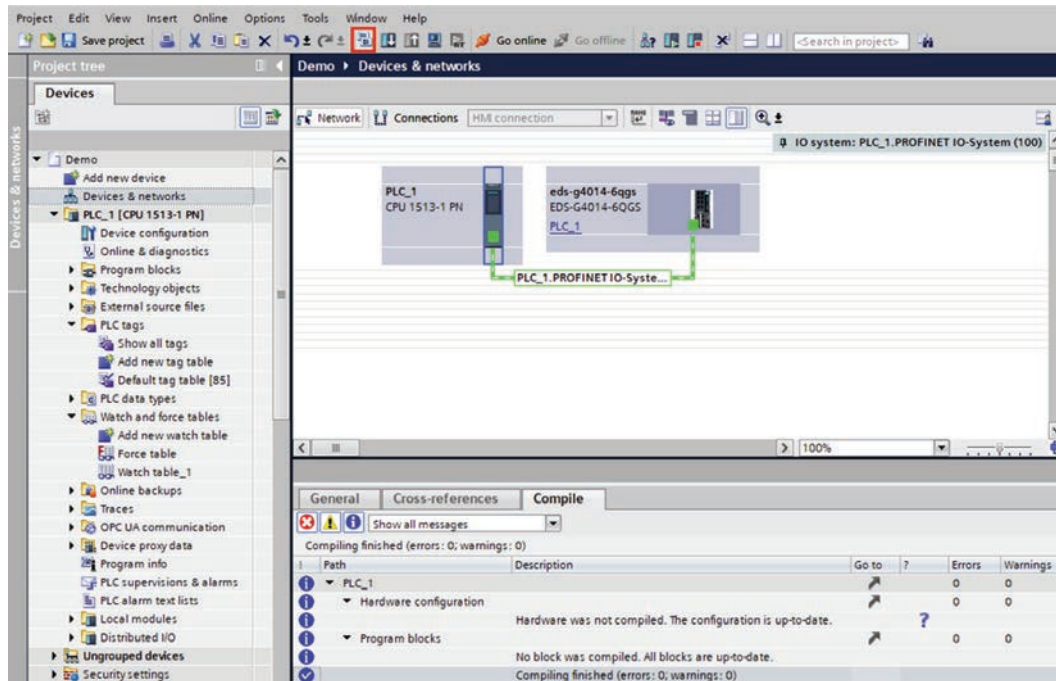

- Download the settings:
 - Click **Download** in the toolbar.
 - Select the corresponding interface and subnet.
 - Click **Start Search**.
 - After the search is finished, click **Load**.

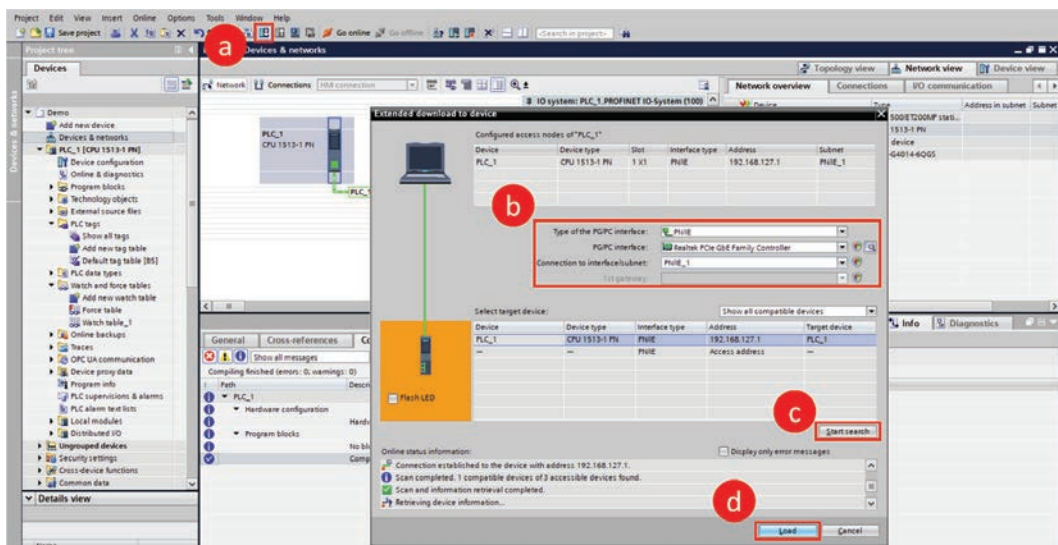

- Click **Monitor All** in the toolbar to view all selected data.

	Name	Address	Display format	Monitor value	Modify value
1	*Cyclic Data - Device Status - All*	%I0	Hex	16#03	<input type="checkbox"/>
2	*Cyclic Data - Device Status*	%I0.0	Bool	<input checked="" type="checkbox"/> TRUE	<input type="checkbox"/>
3	*Cyclic Data - Power 1*	%I0.1	Bool	<input checked="" type="checkbox"/> TRUE	<input type="checkbox"/>
4	*Cyclic Data - Power 2*	%I0.2	Bool	<input type="checkbox"/> FALSE	<input type="checkbox"/>
5	*Cyclic Data - Port Status - All*	%I2	Hex	16#4030	<input type="checkbox"/>
6	*Cyclic Data - Port 1*	%I2.0	Bool	<input type="checkbox"/> FALSE	<input type="checkbox"/>
7	*Cyclic Data - Port 2*	%I2.1	Bool	<input type="checkbox"/> FALSE	<input type="checkbox"/>
8	*Cyclic Data - Port 3*	%I2.2	Bool	<input type="checkbox"/> FALSE	<input type="checkbox"/>
9	*Cyclic Data - Port 4*	%I2.3	Bool	<input type="checkbox"/> FALSE	<input type="checkbox"/>
10	*Cyclic Data - Port 5*	%I2.4	Bool	<input type="checkbox"/> FALSE	<input type="checkbox"/>
11	*Cyclic Data - Port 6*	%I2.5	Bool	<input type="checkbox"/> FALSE	<input type="checkbox"/>
12	*Cyclic Data - Port 7*	%I2.6	Bool	<input checked="" type="checkbox"/> TRUE	<input type="checkbox"/>
13	*Cyclic Data - Port 8*	%I2.7	Bool	<input type="checkbox"/> FALSE	<input type="checkbox"/>
14	*Cyclic Data - Port 9*	%I3.0	Bool	<input type="checkbox"/> FALSE	<input type="checkbox"/>
15	*Cyclic Data - Port 10*	%I3.1	Bool	<input type="checkbox"/> FALSE	<input type="checkbox"/>
16	*Cyclic Data - Port 11*	%I3.2	Bool	<input type="checkbox"/> FALSE	<input type="checkbox"/>
17	*Cyclic Data - Port 12*	%I3.3	Bool	<input type="checkbox"/> FALSE	<input type="checkbox"/>
18	*Cyclic Data - Port 13*	%I3.4	Bool	<input checked="" type="checkbox"/> TRUE	<input type="checkbox"/>
19	*Cyclic Data - Port 14*	%I3.5	Bool	<input checked="" type="checkbox"/> TRUE	<input type="checkbox"/>
20	<Add new>				<input type="text"/>

I/O Device Diagnostics

Moxa PROFINET switches support PROFINET alarms. These alarm messages will be sent by the switch immediately when an event is triggered.

MRP-related alarms can be enabled or disabled using **Media redundancy**.

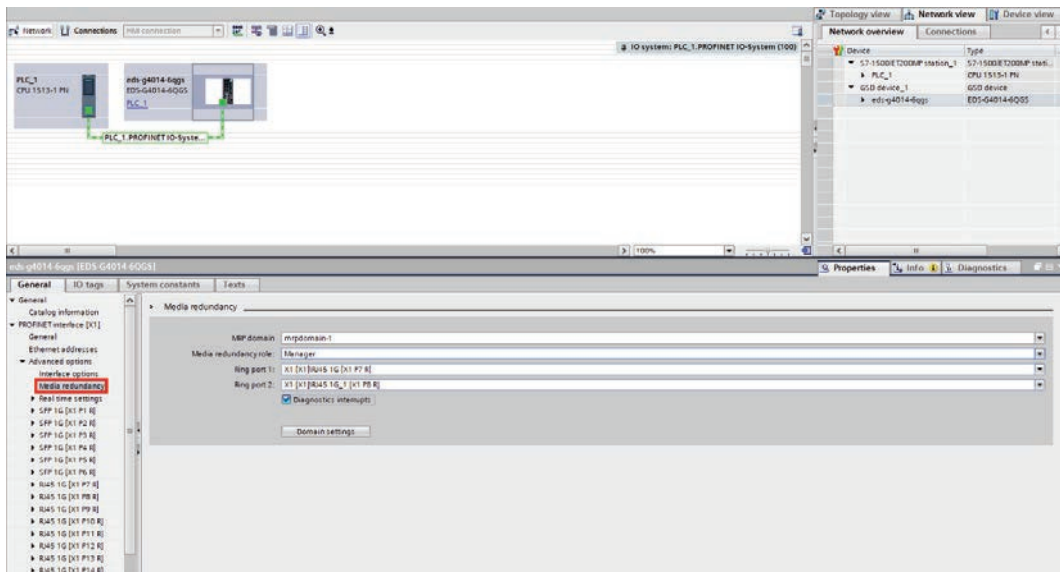

Other alarm types can be enabled or disabled using **Module parameters**.

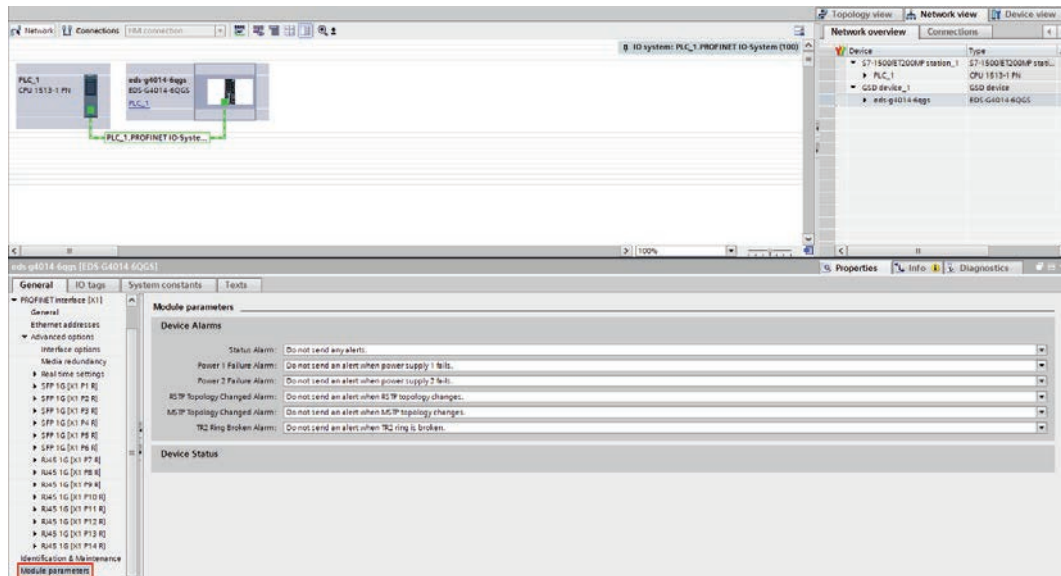

1. Right-click the device and click **Online & diagnostics**.

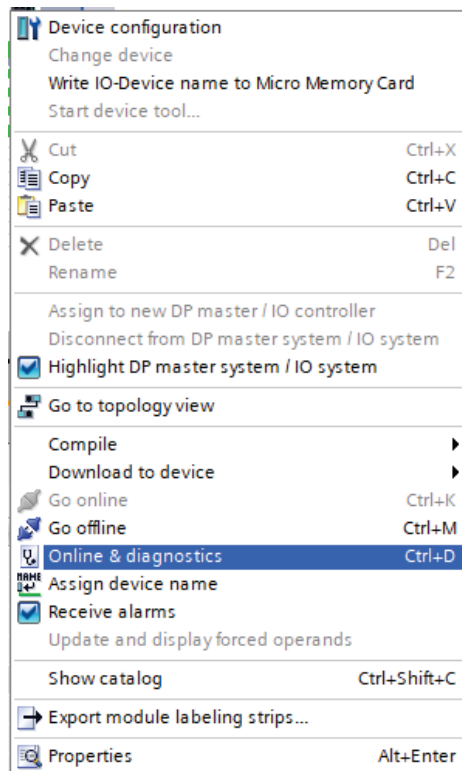

2. Click **Diagnostic status** to view the alarms received by the PLC.

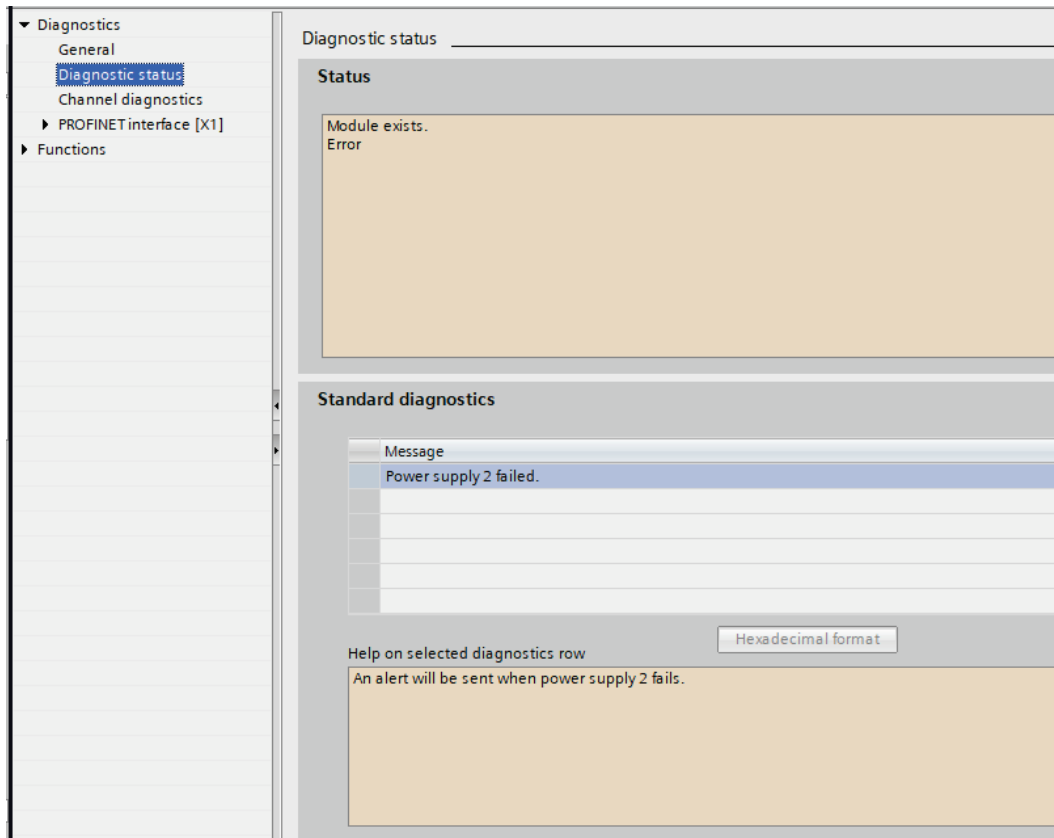

Communication Diagnosis

1. Right-click the device and click **Online & diagnostics**.

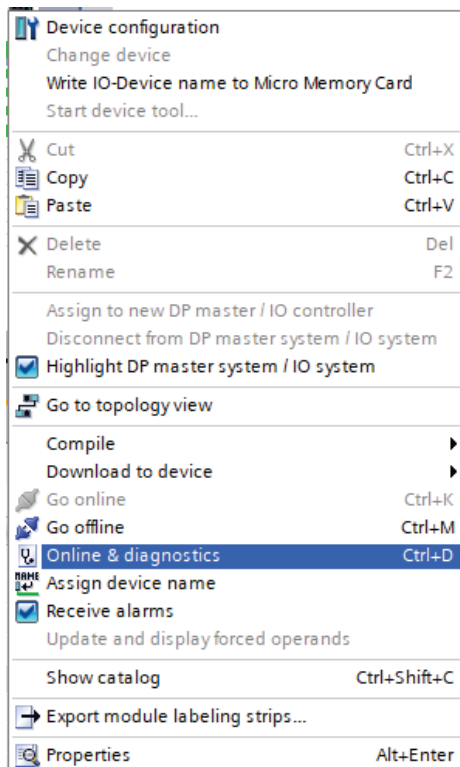

2. Click **Communication diagnostic** to view the connection status.

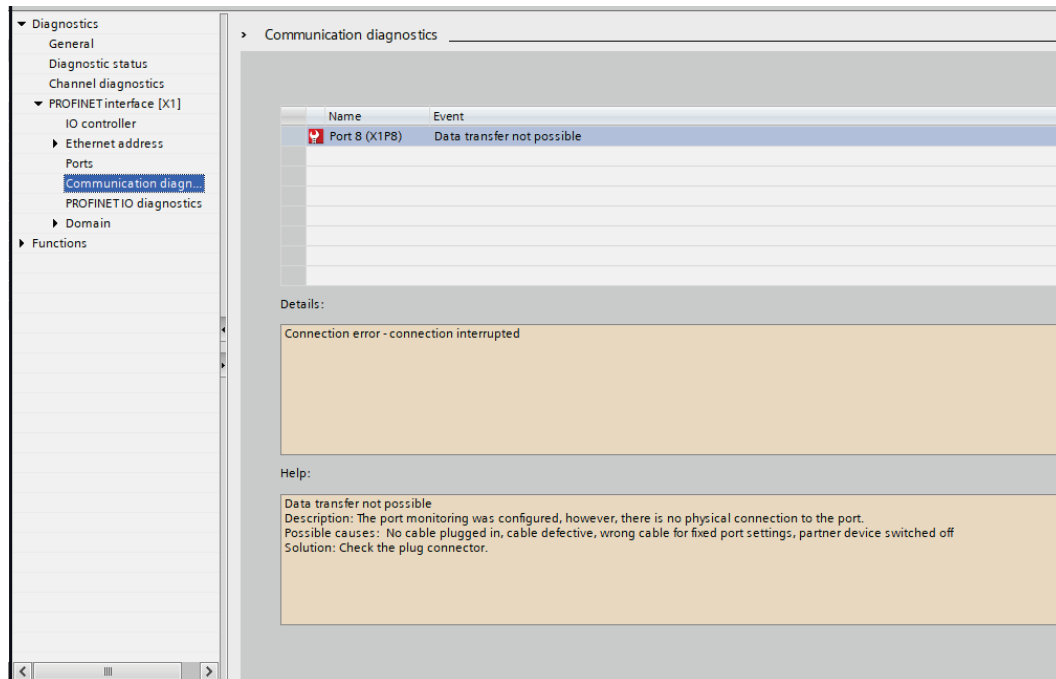

F. CIP Objects of EtherNet/IP

Several communication objects are defined in CIP (Common Industrial Protocol). Moxa switches support the following objects for PLCs and SCADA systems to monitor:

Definition	CIP Object Name	Class ID
ODVA	Identity Object	0x01
	Message Router	0x02
	Assembly	0x04
	Connection Manager Object	0x06
	QoS Object	0x48
	Base Switch Object	0x51
	Port Object	0xF4
	TCP/IP interface Object	0xF5
	Ethernet Link Object	0xF6
	LLDP Management Object	0x109
MOXA	LLDP Data Table Object	0x10A
	Moxa Networking Object (Vendor Specific)	0x404

The supported attributes and services of the above objects are introduced in the table below, including Each object should consist of Class ID, Instance ID, Attribute ID, and Service Code. The supported attributes and services of the above objects are introduced in the following chapters, including the access rules, data type, and description for each attribute.

Identity Object

The Class code of Identity object is **0x01**.

There is **one** instance of this object in our product. It stores the information of the production and the device. The following tables summarize the class attribute, instance attributes, and service code.

Class Attribute List

Attr ID	Access Rule	Name	Data Type	Description
1	Get	Revision	UINT (16)	Revision of this object
2	Get	Max Instance	UINT (16)	Maximum instance number of an object currently created in this class level of the device
3	Get	Number of Instances	UINT (16)	Number of object instances currently created in this class level of the device.
6	Get	Maximum ID Number Class Attributes	UINT (16)	Maximum class attribute ID number implemented in the device
7	Get	Maximum ID Number Instance Attributes	UINT (16)	Maximum instance attribute ID number implemented in the device

Instance Attribute List

Attr ID	Access Rule	Name	(Struct.)	Data Type	Description
1	Get	Vendor ID		UINT (16)	0x3DF , the vendor ID of Moxa is 991.
2	Get	Device Type		UINT (16)	0x2C , "Managed Ethernet Switch".
3	Get	Product Code		UINT (16)	Please refer to Product Code Table .
4	Get	Revision		(Struct.)	Revision of the item the Identity Object represents.
			Major	USINT (8)	The structure member, major. The value zero is not valid. If product version is 0, using 1-base.

Attr ID	Access Rule	Name	(Struct.)	Data Type	Description
			Minor	USINT (8)	The structure member, minor. The value zero is not valid. If product version is 0, using 1-base.
5	Get	Status		WORD (16)	Summary status of the device.
6	Get	Serial Number		UDINT (32)	The serial number of each device.
7	Get	Product Name		SHORT_STRING	The product model of the Moxa switch. Maximum length is 32 characters.
15	Get/Set	Assigned Name		STRINGI	Switch device's host name.
17	Get/Set	Geographic Location		STRINGI	The assigned switch location.

The Identity Object Instance supports the following CIP Common services:

Common Service List

Service Code	Implementation		Service Name	Description
	Class	Instance		
0x01	✓	✓	Get_Attributes_All	Returns the contents of all attributes of the class
0x0E	✓	✓	Get_Attribute_Single	Used to read an object instance attribute.
0x10		✓	Set_Attribute_Single	Used to write an object instance attribute
0x05		✓	Reset	Invokes the reset service for the device
0x18		✓	Get_Member	Returns the content of a selected member of an attribute

Message Router Object

The Class code of Message Router Object is **0x02**. The object within a node that distributes messaging requests to the appropriate application objects.

The supported messaging connections are as the following:

- Explicit Messaging
- Unconnected Messaging
- Implicit messaging

When using the UCMM to establish an explicit messaging connection, the target application object is the Message Router object.

Class Attribute List

Attr ID	Access Rule	Name	Data Type	Descriptions
1	Get	Revision	UINT (2)	Revision of this object

Instance Attribute List

Attr ID	Access Rule	Name	(Struct.)	Data Type	Description
1	Get	Object_list		(Struct.)	A list of supported objects
			Number	UINT (16)	Number of supported classes in the classes array
			Classes	Array of UINT (16)	List of supported class codes
2	Get	Number Available		UINT (16)	Maximum number of connections supported
3	Get	Number Active		UINT (16)	Number of connections currently used by system components
4	Get	Active Connections		Array of UINT (16)	A list of the connection IDs of the currently active connections

Common Service List

Service Code	Implementation		Service Name	Description
	Class	Instance		
0x0E		✓	Get_Attribute_Single	Used to read an object instance attribute

Assembly Object

The Moxa switch support **static** assembly object for CIP I/O messaging.

The Class code is **0x04**.

There are three instances of this object:

For RKS-G4000 Series, MDS-G4000 Series, and MDS-G4000-4XG Series:

	Instance Number	Size (32 bit)
Output	1	8
Input	2	20
Configuration	3	0

For EDS-4000 Series and EDS-G4000 Series:

	Instance Number	Size (bytes)
Output	1	18
Input	50	16
Configuration	100	10

The **Input** means the data is produced by switch which includes the information and status report to the originator for monitoring. The **Output** means the data is generated by the originator (remote host) and is consumed by switch.

Class Attribute List

Attr ID	Access Rule	Name	Data Type	Description
1	Get	Revision	UINT (16)	Revision of this object

Instance Attribute List

Attr ID	Access Rule	Name	Data Type	Description
3	Get/Set	Data	Array of BYTE	The implicit messaging content
4	Get	Size	UINT (16)	Number of bytes in Attr. 3

Common Service List

Service Code	Implementation		Service Name	Description
	Class	Instance		
0x0E	✓	✓	Get_Attribute_Single	Used to read an object instance attribute
0x10		✓	Set_Attribute_Single	Used to modify an object instance attribute

For the definition of the I/O messaging, see the following table for details.

I/O Messaging Content

For RKS-G4000 Series, MDS-G4000 Series, and MDS-G4000-4XG Series:

Direction	I/O data	Size	Value & Description
Input	Relay Alarm Status	UDINT (32)	Please refer to Moxa Networking Object Attr ID 3.
	Existing Port	ULINT (64)	Please refer to Base Switch Object's Attr ID 6.
	Global Port Link Status	ULINT (64)	Please refer to Base Switch Object's Attr ID 8.
Output	Global Port Admin State	ULINT (64)	Please refer to Base Switch Object's Attr ID 7.

For EDS-4000 Series and EDS-G4000 Series:

Direction	Instance	Byte	Bit 7	Bit 6	Bit 5	Bit 4	Bit 3	Bit 2	Bit 1	Bit 0
Input	1	0	Power Source Status (Least Significant Byte)							
		1	Power Source Status (Most Significant Byte)							
		2-5	Global Link Status DWORD 0							
		6-9	Global Link Status DWORD 1							
		10-13	Global Link Status DWORD 2							
		14-17	Global Link Status DWORD 3							
Output	50	0-3	Global Admin State DWORD 0							
		4-7	Global Admin State DWORD 1							
		8-11	Global Admin State DWORD 2							
		12-15	Global Admin State DWORD 3							

Mapping I/O Assembly Data Attribute Components



NOTE

Only for the EDS-4000 Series and EDS-G4000 Series.

The following table indicates the I/O assembly Data attribute mapping for the Managed Ethernet Switch device.

Data Component Name	Class	Instance	Attribute	
			Name	Number
Power Source Status	Base Switch Object	1	Power Source	4
Global Admin State			Global Port Admin State	7
Global Link Status			Global Port Link Status	8

Connection Manager Object

The class code of Connection Manager Object is **0x06**. The Connection Manager Object allocates and manages the internal resources associated with both I/O and Explicit Messaging connections. There is one instance of this object. The supported connection trigger type is cyclic and change of state (COS).

The instance attribute list is introduced as the following.

Class Attribute List

Attr ID	Access Rule	Name	Data Type	Description
1	Get	Revision	UINT (16)	Revision of this object.

Instance Attribute List

Attr ID	Access Rule	Name	Data Type	Description
1	Get/Set	Open Requests	UINT(16)	Number of Forward_Open service requests received. A device may reject a set request to this attribute, using General Status Code 0x09 (Invalid Attribute Value), if the attribute value sent is not zero. (Vol1_3.33 3-5.2 Instance Attributes)

Common Service List

Service Code	Implementation		Service Name	Description
	Class	Instance		
0x0e	✓	✓	Get_Attribute_Single	Used to read an object instance attribute.
0x10		✓	Set_Attribute_Single	Used to modify an object instance attribute.
0x4E		✓	Forward_Close	Closes a connection.
0x54		✓	Forward_Open	Opens a connection. Maximum data size is 511 bytes.

QoS Object



NOTE

For the EDS-4000 and EDS-G4000 Series only.

The QoS Object provides a means to configure certain QoS-related behaviors in EtherNet/IP devices. The class code of QoS Object is 0x48. The following table defines the default DSCP mappings for EtherNet/IP.

Traffic Type	CIP Priority	DSCP	CIP Traffic Usage (Recommended)
CIP class 0/1	Urgent (3)	55	CIP Motion
	Scheduled (2)	47	Safety I/O I/O
	High (1)	43	I/O

Traffic Type	CIP Priority	DSCP	CIP Traffic Usage (Recommended)
	Low (0)	31	No recommendation at present
<ul style="list-style-type: none"> CIP UCMM CIP class 2/3 All other EtherNet/IP Encapsulation messages 	All	27	CIP messaging

Class Attribute

Attr ID	Access Rule	Name	Data Type	Description
1	Get	Revision	UINT (16)	Revision of this object.

Instance Attribute

Attr ID	Access Rule	Name	Data Type	Description
4	Get/Set	DSCP Urgent	USINT (8)	CIP transport class 0/1 messages with Urgent priority
5	Get/Set	DSCP Scheduled	USINT (8)	CIP transport class 0/1 messages with Scheduled priority
6	Get/Set	DSCP High	USINT (8)	CIP transport class 0/1 messages with High priority
7	Get/Set	DSCP Low	USINT (8)	CIP transport class 0/1 messages with Low priority
8	Get/Set	DSCP Explicit	USINT (8)	CIP UCMM CIP transport class 2/3 All other EtherNet/IP encapsulation messages

Any change to the value of the above attributes will only take effect after the device is restarted.

Common Service

Service Code	Implementation		Service Name	Description
	Class	Instance		
0x0E	✓	✓	Get_Attribute_Single	Used to read an object instance attribute.
0x10		✓	Set_Attribute_Single	Used to modify an object instance attribute.

Base Switch Object

The class code of Base Switch Object is 0x51. The Base Switch Object provides the CIP application-level interface and basic status information for a Managed Ethernet switch device.

Devices shall implement no more than one instance of the Base Switch Object.

Class Attribute List

Attr ID	Access Rule	Name	Data Type	Description
1	Get	Revision	UINT (16)	Revision of this object. The current value assigned to this is 1.

Instance Attribute List

Attr ID	Access Rule	Name	Data Type	Description
1	Get	Device Up Time	UDINT (32)	Time since device was powered up.
2	Get	Total Port Count	UDINT (32)	Number of physical available ports.
3	Get	System Firmware Version	SHORT_STRING	Human readable representation of System Firmware Version. Maximum length is 32 characters.
4	Get	Power Source	WORD (16)	Status of switch power source. Bits 0-1: State of the Power Source 1. 00 = Not Present (Power source not present in switch) 01 = Not Powered (Power source present but not powered) 10 = Faulted(internal) (Power source present but faulted) 11 = Powered and ok

Attr ID	Access Rule	Name	Data Type	Description
				(Power source present, powered, and OK) Bits 2-3: State of the Power Source 2. The values are same as bits 0-1. Bits 4-5: State of the Power Source 3. The values are same as bits 0-1. Bits 6-7: State of the Power Source 4. The values are same as bits 0-1. Bits 8-9: State of the Power Source 5. The values are same as bits 0-1. Bits 10-11: State of the Power Source 6. The values are same as bits 0-1. Bits 12-13: State of the Power Source 7. The values are same as bits 0-1. Bits 14-15: State of the Power Source 8. The values are same as bits 0-1.
5	Get	Port Mask Size	UINT (16)	Number of DWORDs in port array attributes. Minimum = 4, supporting 128 ports.
6	Get	Existing Port	ARRAY OF DWORD (32)	Switch existing port. 0 = Port Absent 1 = Port Present
7	Get	Global Port Admin State	ARRAY OF DWORD (32)	Port Admin State. 0 = Port Disabled 1 = Port Enabled
8	Get	Global Port Link Status	ARRAY OF DWORD (32)	Ports Link Status. 0 = Link Inactive (Down) 1 = Link Active (Up) Bit 0-31: Port 0-31 Link status.

Common Service List

Service Code	Implementation		Service Name	Description
	Class	Instance		
0x0E	✓	✓	Get_Attribute_Single	Used to read an object instance attribute.

Port Object

The port object represents the underlying interface of CIP which is EtherNet/IP.

The class code is **0xf4**. There is one instance of this object.

The instance attribute "**Port Type**" identifies the CIP adaptation.

Class Attribute List

Attr ID	Access Rule	Name	(Struct.)	Data Type	Description
1	Get	Revision		UINT (16)	Revision of this object
2	Get	Max Instance		UINT (16)	Maximum instance number of an object currently created in this class level of the device
3	Get	Number of Instances		UINT (16)	Number of object instances currently created at this class level of the device.
8	Get	Entry Port		UINT (16)	Returns the instance of the Port Object that describes the port through which this request entered the device.
9	Get	Port Instance Info	Port Type	UINT (16)	Enumerates the type of port.
			Port Number	UINT (16)	CIP port number associated with this port

Instance Attribute List

Attr ID	Access Rule	Name	(Struct.)	Data Type	Description
1	Get	Port Type		UINT (16)	Enumerates the type of port. 4 = EtherNet/IP.

Attr ID	Access Rule	Name	(Struct.)	Data Type	Description
2	Get	Port Number		UINT (16)	CIP port number associated with this port. (Values 0-1 are reserved and cannot be used)
3	Get	Link Object	Path Length	UINT (16)	Number of 16 bit words in the following path.
			Link Path	Padded EPATH	Logical path segments that identify the object for this port.
4	Get	Port Name		SHORT_STRING	Vendor assigned name of the communications interface. The value is always "EIP Port".
5	Get	Port Type Name		SHORT_STRING	String which names the port type. If Port Type value is 4 (EtherNet/IP), its associated Port Type Name is "EtherNet/IP". The value is always "EtherNet/IP".
7	Get	Node Address		Padded EPATH	This is a single Port Segment containing the Port Number of this port and the Link Address of this device on this port.
9	Get	Port Key		Packed EPATH	The electronic key of the chassis this port is attached to. This attribute shall be limited to format 4 of the Logical Electronic Key segment. The Vendor ID, Device Type, Product Code, Major Revision and Minor Revision fields shall not be 0. The Compatibility field shall be 0 (indicating match). (Only for the RKS-G4000 Series, MDS-G4000 Series, and MDS-G4000-4XG Series.)
10	Get	Port Routing Capabilities		DWORD (32)	Bit string that defines the routing capabilities of this port.

Common Service List

Service Code	Implementation		Service Name	Description
	Class	Instance		
0x0E	✓	✓	Get_Attribute_Single	Used to read an object instance attribute

TCP/IP Interface Object

The Class code of TCP/IP Interface object is **0xf5**. The TCP/IP Interface Object provides the mechanism to configure a device's TCP/IP network interface. Examples of configurable items include the device's IP Address, Network Mask, and Gateway Address. There is **one** instance of this object.

The following tables summarize the attributes of this object.

Class Attribute List

Attr ID	Access Rule	Name	Data Type	Description
1	Get	Revision	UINT (16)	Revision of this object.
2	Get	Max Instance	UINT (16)	Maximum instance number of an object currently created in this class level of the device
3	Get	Number of Instances	UINT (16)	Number of object instances currently created at this class level of the device
6	Get	Maximum ID Number Class Attributes	UINT (16)	Maximum class attribute ID number implemented in the device.
7	Get	Maximum ID Number Instance Attributes	UINT (16)	Maximum instance attribute ID number implemented in the device.

Instance Attribute List

Attr ID	Access Rule	Name	(Struct.)	Data Type	Description
1	Get	Status		DWORD (32)	Interface status 0 = The Interface Configuration attribute has not been configured. 1 = The Interface Configuration attribute contains valid configurations obtained from BOOTP, DHCP or non-volatile storage.
2	Get	Configuration Capability		DWORD (32)	Indicates the device's support for optional network configuration capability. 0 = Device is not capable. 1 = Device is capable. Bit map of capability flags: Bit 0: BOOTP Client Bit 1: DNS Client Bit 2: DHCP Client Bit 3: DHCP-DNS Update Bit 4: Configuration Settable
3	Get/Set	Configuration Control		DWORD (32)	Interface control flags Bit map of control flags: Bit 0 to 3: Startup Configuration 0 = The device shall use the interface configuration values previously stored (for example, in non-volatile memory or via hardware switches). 1 = The device shall obtain its interface configuration values via BOOTP. 2 = The device shall obtain its interface configuration values via DHCP upon start-up. 3 to 15 = Reserved.
4	Get	Physical Link Object	Path Size	UINT (16)	Size of Path
			Path	Padded EPATH	Logical segments identifying the physical link object
5	Get/Set	Interface Configuration	IP Address	UDINT (32)	The device's IP address
			Network Mask	UDINT (32)	The device's network mask
			Gateway Address	UDINT (32)	Default gateway address
			Name Server	UDINT (32)	Primary name server
			Name Server2	UDINT (32)	Secondary name server
			Domain Name	STRING	Default domain name. Maximum length is 48 characters. A length of 0 shall indicate no Domain Name is configured. Set Domain Name is not supported in Moxa switch.
6	Get/Set	Host Name		STRING	Host name. ASCII characters. Maximum length is 64 characters.
13	Get/Set	Encapsulation Inactivity Timeout		UNIT (16)	Number of seconds of inactivity before TCP connection is closed. Default = 120 0 = Disable timeout 1-3600 = timeout in seconds

The TCP/IP Object Instance supports the following CIP Common services:

Common Service List

Service Code	Implementation		Service Name	Description
	Class	Instance		
0 x 01	✓	✓	Get_Attributes_All	Returns the contents of all attributes of the class
0 x 0E	✓	✓	Get_Attribute_Single	Used to read an object instance attribute
0 x 10		✓	Set_Attribute_Single	Used to modify an object instance attribute

Ethernet Link Object

The Class code of Ethernet Link object is **0xf6** (Defined in CIP Vol2, 5-4). For each switch port, there is an instance of this class. The following table shows the mapping of instance number and the switch port number.

Instance Number	Mapping to
0	Ethernet Link class
1	1st switch port
2	2nd switch port
3	3rd switch port
...	...

The following tables summarize the attributes of the Ethernet Link object.

There are some vendor specific attributes in the table (Starting from attribute Id 100).

Class Attribute List

Attr ID	Access Rule	Name	Data Type	Description
1	Get	Revision	UINT (16)	Revision of this object
2	Get	Max Instance	UINT (16)	Maximum instance number of an object currently created in this class level of the device
3	Get	Number of Instances	UINT (16)	Number of object instances currently created in this class level of the device
6	Get	Maximum ID Number Class Attributes	UINT (16)	Maximum class attribute ID number implemented in the device.
7	Get	Maximum ID Number Instance Attributes	UINT (16)	Maximum instance attribute ID number implemented in the device.
100	Get	Moxa-specific Revision	UINT (16)	Revision of Moxa specific attributes and services for Linux platform switch. The current value assigned is 1.

Instance Attribute List

Attr ID	Access Rule	Name	(Struct.)	Data Type	Description
1	Get	Interface Speed		UDINT (32)	Interface speed currently in use. The scale of the attribute is in Mbps. (Speed in Mbps, e.g., 0, 10, 100, 1000, etc.)
2	Get	Interface Flags		DWORD (32)	Refer to the Interface Flags table.
3	Get	Physical Address		ARRAY of 6 USINT (8)	Interface's MAC layer address.
4	Get	Interface Counters	In Octets	UDINT (32)	Octets received on the interface.
			In Ucast Packets	UDINT (32)	Unicast packets received on the interface.
			In NUCast Packet	UDINT (32)	Non-unicast packets received on the interface.
			In Discards	UDINT (32)	Inbound packets received on the interface but are discarded.
			In Errors	UDINT (32)	Inbound packets that contain Errors (does not include In Discards).
			In Unknown Protos	UDINT (32)	Inbound packets with unknown protocol.
		Out Octets	UDINT (32)	Octets sent on the interface.	

Attr ID	Access Rule	Name	(Struct.)	Data Type	Description
			Out Ucast Packets	UDINT (32)	Unicast packets sent on the interface.
			Out NUcast Packets	UDINT (32)	Non-unicast packets sent on the interface.
			Out Discards	UDINT (32)	Discarded outbound packets.
			Out Errors	UDINT (32)	Outbound packets that contain errors.
5	Get	Media Counters	Alignment Errors	UDINT (32)	Received frames that are not an integral number of octets in length.
			FCS Errors	UDINT (32)	Received frames that do not pass the FCS check.
			Single Collisions	UDINT (32)	Successfully transmitted frames which experienced exactly one collision.
			Multiple Collisions	UDINT (32)	Successfully transmitted frames which experienced more than one collision.
			SQE Test Errors	UDINT (32)	Number of times the SQE test error message is generated.
			Deferred Transmissions	UDINT (32)	Frames for which the first transmission attempt is delayed because the medium is busy.
			Late Collisions	UDINT (32)	Number of times a collision is detected later than 512 bit times into the transmission of a packet.
			Excessive Collisions	UDINT (32)	Frames for which transmission fails due to excessive collisions.
			MAC Transmit Errors	UDINT (32)	Frames for which transmission fails due to an internal MAC sublayer transmit error.
			Carrier Sense Errors	UDINT (32)	Times that the carrier sense condition was lost or never asserted when attempting to transmit a frame.
			Frame Too Long	UDINT (32)	Received frames that exceed the maximum permitted frame size.
			MAC Receive Errors	UDINT (32)	Frames for which reception on an interface fails due to an internal MAC sublayer receive error.
			6	Get/Set	Interface Control
Control Bits	WORD (16)	Bit 0: Auto-Negotiate Value 0: Force Value 1: Auto-Nego Bit 1: Forced Duplex Mode Value 0: half duplex Value 1: full duplex Bit 2 to 15: Reserved, all zero			
			Forced Interface Speed	UINT (16)	Speed at which the interface shall be forced to operate. Speed in Mbps (10, 100, 1000, etc.)
10	Get	Interface Label		SHORT_STRING	Port description. Maximum length is 64 characters.
11	Get	Interface Capability		(Struct.)	Indication of capabilities of the interface
		Capability Bits		DWORD (32)	Interface capabilities, other than speed/duplex. Bit 0: Manual Setting Requires Reset Value 0: The device automatically applies changes made to the Interface Control attribute (#6). Doesn't require a reset in order for changes to take effect. Value 1: The device doesn't automatically apply changes made to the Interface

Attr ID	Access Rule	Name	(Struct.)	Data Type	Description
					Control attribute (#6). Require a reset in order for changes to take effect. Bit 1: Auto-Negotiate Value 0: Not support AN Value 1: Support AN Bit 2: Auto-MDIX Value 0: Not support auto MDIX Value 1: Support auto MDIX Bit 3: Manual Speed/Duplex Value 0: Not support manual setting of speed/duplex. Value 1: Supports manual setting of speed/duplex via the Interface Control attribute (#6) Bit 4 to 31: Reserved, all zero
		Speed/Duplex Options		(Struct.)	Indicates speed/duplex pairs supported in the Interface Control attribute.
12	Get	HC Interface Counters	HCIInOctets	ULINT (64)	The total number of octets received on the interface. This counter is a 64-bit version of In Octets.
			HCIInUcastPkts	ULINT (64)	Unicast packets received on the interface. This counter is a 64-bit version of In Ucast Packets.
			HCIInMulticastPkts	ULINT (64)	Multicast packets received on the interface.
			HCIInBroadcastPkts	ULINT (64)	Broadcast packets received on the interface.
			HCOOutOctets	ULINT (64)	Octets sent on the interface. This counter is a 64-bit version of Out Octets.
			HCOOutUcastPkts	ULINT (64)	Unicast packets sent on the interface. This counter is a 64-bit version of Out Ucast Packets.
			HCOOutMulticastPkts	ULINT (64)	Multicast packets sent on the interface.
			HCOOutBroadcastPkts	ULINT (64)	Broadcast packets sent on the interface.
13	Get	HC Media Counters	HCStatsAlignmentErrors	ULINT (64)	Frames received that are not an integral number of octets in length and do not pass the FCS check. This counter is a 64-bit version of Alignment Errors.
			HCStatsFCS Errors	ULINT (64)	Frames received that are an integral number of octets in length but do not pass the FCS check. This counter is a 64-bit version of FCS Errors.
			HCStatsInternalMacTransmitErrors	ULINT (64)	Frames for which transmission fails due to an internal MAC sublayer transmit error. This counter is a 64-bit version of MAC Transmit Errors.
			HCStatsFrameTooLong s	ULINT (64)	Frames received that exceed the maximum permitted frame size. This counter is a 64-bit version of Frame Too Long Errors.
			HCStatsInternalMacReceiveErrors	ULINT (64)	Frames for which reception on an interface fails due to an internal MAC sublayer receive error. This counter is a 64-bit version of MAC Receive Errors.

Attr ID	Access Rule	Name	(Struct.)	Data Type	Description
			HCStatsSymbolErrors	ULINT (64)	Number of times there was an invalid data symbol on the media when a valid carrier was present.
100	Get	Port State		USINT (8)	Switch port state. Value 1 = Disable Value 2 = Blocking Value 3 = Listening Value 4 = Learning Value 5 = Forwarding Value 6 = Broken
101	Get	Media Type		STRING	Port media type.
102	Get/Set	Traffic Storm Control		USINT (8)	Traffic storm control enable. 0 = Disabled 1 = Enabled Bit 0: Broadcast storm control Bit 1: Multicast storm control Bit 2: DLF storm control
103	Get/Set	Port On event		USINT (8)	Registered port for port on event notification. 0 = Unregistered. 1 = Registered.
104	Get/Set	Port Off event		USINT (8)	Registered port for port off event notification. 0 = Unregistered. 1 = Registered.
105	Get/Set	Port shut down by Port Security event		USINT (8)	Registered port for port shut down by Port Security event notification. 0 = Unregistered. 1 = Registered.
106	Get/Set	Port shut down by Rate Limit event		USINT (8)	Registered port for port shut down by Rate Limit event notification. 0 = Unregistered. 1 = Registered.
107	Get/Set	Port recovered by Rate Limit event		USINT (8)	Registered port for port recovered by Rate Limit event notification. 0 = Unregistered. 1 = Registered.
108	Get/Set	Fiber Check Warning		USINT (8)	Registered port for fiber check warning event notification. 0 = Unregistered. 1 = Registered.

Interface Flags

Bit(s)	Called	Definition
0	Link Status	0 indicates an inactive link; 1 indicates an active link.
1	Half/Full Duplex	0 indicates half duplex; 1 indicates full duplex.
2-4	Negotiation Status	Indicates the status of link auto-negotiation 0 = Auto-negotiation in progress. 1 = Auto-negotiation and speed detection failed. Using default values for speed and duplex. Default values are product-dependent; recommended defaults are 10Mbps and half duplex. 2 = Auto negotiation failed but detected speed. Duplex was defaulted. Default value is product-dependent; recommended default is half duplex. 3 = Successfully negotiated speed and duplex. 4 = Auto-negotiation not attempted. Forced speed and duplex.

Bit(s)	Called	Definition
5	Manual Setting Requires Reset	0 indicates the interface can activate changes to link parameters (auto-negotiate, duplex mode, interface speed) automatically. 1 indicates the device requires a Reset service be issued to its Identity Object in order for the changes to take effect.
6	Local Hardware Fault	0 indicates the interface detects no local hardware fault; 1 indicates a local hardware fault is detected. The meaning of this is product-specific. For example, an AUI/MII interface might detect no transceiver attached, or a radio modem might detect no antenna attached. In contrast to the soft, possibly self-correcting nature of the Link Status being inactive, this is assumed a hard-fault requiring user intervention.
7~31	Reserved.	Shall be set to zero

The Ethernet Link Object Instance supports the following CIP common services:

Common Service List

Service Code	Implementation		Service Name	Description
	Class	Instance		
0x0E	✓	✓	Get_Attribute_Single	Used to read an object instance attribute
0x10		✓	Set_Attribute_Single	Used to modify an object instance attribute

LLDP Management Object

The LLDP Management Object contains administrative information for the LLDP protocol. Only one instance of the LLDP Management Object shall be implemented. The class code of LLDP Management Object is 0x109.



NOTE

Only for the EDS-4000 Series and EDS-G4000 Series.

Class Attribute

Attr ID	Access Rule	Name	Data Type	Description
1	Get	Revision	UINT (16)	Revision of this object. The current value assigned to this value is 1.

Instance Attribute

Attr ID	Access Rule	Name	(Struct.)	Data Type	Description
1	Get/Set	LLDP Enable		(Struct.)	
			LLDP Enable Array Length	UINT (16)	Number of bits defined in the LLDP Enable Array member of this structure.
1	Get/Set	LLDP Enable	LLDP Enable Array	Array of BYTE (8)	Bit 0 : Global Enable 0 = LLDP Tx & Rx Disabled 1 = LLDP Tx & Rx Enabled Bit 1-N : Port Tx Enable 0 = LLDP Tx Disabled 1 = LLDP Tx Enabled Bit >N : Reserved Shall be zero and ignored.
					Message Transmission Interval for LLDP frames. 0 = Reserved 1 - 3600 = Transmit interval (sec.) 3601 - 65535 = Reserved Recommended default value is 30. Note : MOXA real supported transmit interval range is 5-32768.
2	Get/Set	msgTxInterval		UINT (16)	

Attr ID	Access Rule	Name	(Struct.)	Data Type	Description
3	Get/Set	msgTxHold		USINT (8)	Message Transmission Multiplier for LLDP Frames 0 = Reserved 1 - 100 = Transmission Multiplier 101 - 255 = Reserved Recommended default value is 4. Note : MOXA real supported transmit hold time multiplier range is 2-10.
4	Get	LLDP Datastore		WORD (16)	An indication of the retrieval methods for the LLDP database supported by the device. Bit: 0 = LLDP Data Table Object 1 = SNMP 2 = NETCONF YANG 3 = RESTCONF YANG 4 - 15 = Reserved At least one of bits 0 & 1 are required.
5	Get	Last Change		UDINT (32)	The value of sysUpTime taken the last time any entry in the local LLDP database (ignoring TTL) changed.

Common Service

Service Code	Implementation		Service Name	Description
	Class	Instance		
0x0E	✓	✓	Get_Attribute_Single	Used to read an object instance attribute.
0x10		✓	Set_Attribute_Single	Used to modify an object instance attribute.

LLDP Data Table Object

The LLDP Data Table object displays a record of all adjacent LLDP implementing devices that are currently active according to the receive state machine of the LLDP protocol.

An instance of the LLDP Data Table object shall be implemented per adjacent device detected. Instances shall be created and removed as neighboring devices change. The same instance number should be maintained for each neighboring device until the next power cycle of the device implementing this object.

The class code of the LLDP Data Table Object is 0x10A.



NOTE

Only for the EDS-4000 Series and EDS-G4000 Series.

Class Attribute

Attr ID	Access Rule	Name	Data Type	Description
1	Get	Revision	UINT (16)	Revision of this object. The current value is 1.
2	Get	Max Instance	UINT (16)	Maximum instance number of an object currently created in this class level of the device.
3	Get	Number of Instances	UINT (16)	Number of object instances currently created in this class level of the device.
6	Get	Maximum ID Number Class Attributes	UINT (16)	Maximum class attribute ID number implemented in the device.
7	Get	Maximum ID Number Instance Attributes	UINT (16)	Maximum instance attribute ID number implemented in the device.

Instance Attribute

Attr ID	Access Rule	Name	(Struct.)	Data Type	Description
1	Get	Ethernet Link Instance Number		UINT (16)	The physical Ethernet port the LLDP frame populating this instance was received on. 0 = Unknown 1-65535 = Ethernet Link Object (0xF6) Instance Number
2	Get	MAC Address		ETH_MAC_ADDRESS	The MAC address will be set by the first occurrence of a MAC ID that exists in the following list: 1. The CIP MAC Address (TLV Type = 127, Subtype = 2) 2. The Chassis ID (TLV Type = 1) only if subtype = 2 3. The Port ID (TLV Type = 2) only if subtype = 3 4. All zero
3	Get	Interface Label		SHORT_STRING	The Interface Label will be a maximum of 64 characters. It is set by the first occurrence of an interface label that exists in the following list: 1. The CIP Interface Label (TLV Type = 127, Subtype = 1) 2. The Chassis ID (TLV Type = 1) only if subtype = 6 3. The Port ID (TLV Type = 2) only if subtype = 5 4. A null string
4	Get	Time to Live		UINT (16)	The number of seconds the neighboring information is to be considered valid. 0 = Reserved 1-65535 = Time To Live (in seconds)
5	Get	System Capabilities TLV		(Struct.)	A structure that contains bitmaps of both the supported and enabled capabilities of the neighboring device.
			System Capabilities	WORD (16)	The capabilities which the neighboring device supports based on currently loaded firmware. Bit 0: Other Bit 1: Repeater Bit 2: Bridge Bit 3: Access Point Bit 4: Router Bit 5: Telephone Bit 6: DOCSIS Cable Device Bit 7: End Station Bit 8: C-VLAN component Bit 9: S-VLAN component Bit 10: Two-port MAC Relay Component Bit 11-15: Reserved by IEEE Note: EtherNet/IP Bridged multiport neighboring devices are expected to assert high bits 0 & 2.

Attr ID	Access Rule	Name	(Struct.)	Data Type	Description
			Enabled Capabilities	WORD (16)	The capabilities currently enabled on the neighboring device. Bit 0: Other Bit 1: Repeater Bit 2: Bridge Bit 3: Access Point Bit 4: Router Bit 5: Telephone Bit 6: DOCSIS Cable Device Bit 7: End Station Bit 8: C-VLAN component Bit 9: S-VLAN component Bit 10: Two-port MAC Relay Component Bit 11-15: Reserved by IEEE Note: EtherNet/IP Bridged multiport neighboring devices are expected to assert high bits 0 & 2.
6	Get	IPv4 Management Address		(Struct.)	The IPv4 management addresses of the neighboring device.
			Management Address Count	USINT	0-255 = Number of received Management Address TLV's from this neighbor.
			Management Address	ARRAY of UDINT (32)	The IP address shall be set to a valid Class A, B, or C address. And shall not be set to all zeros or the loopback address (127.0.0.1).
7	Get	CIP Identification		(Struct.)	The CIP Identification TLV of the neighboring device, if present. Set by the CIP Identification TLV (TLV Type = 127, Subtype = 09), if present. Otherwise 0
			Vendor ID	UINT (16)	Vendor ID
			Device Type	UINT (16)	Device Type
			Product Code	UINT (16)	Product Code
			Major Revision	BYTE (8)	Major Revision
			Minor Revision	USINT (8)	Minor Revision
			CIP Serial Number	UDINT (32)	Serial Number – Shall not be zero 0.
8	Get	Additional Ethernet Capabilities		(Struct.)	A TLV for Ethernet Preemption Support from the neighboring device. Set by the Additional Ethernet Capabilities TLV (TLV type = 127, Subtype 7), if present. Otherwise, 0.
			Preemption Support	BOOL (8)	Allows a link partner to know if preemption is supported on the link. 0 = Not Supported 1 = Supported
			Preemption Status	BOOL (8)	Allows a link partner to know if preemption is enabled on the link. 0 = Not Enabled 1 = Enabled

Attr ID	Access Rule	Name	(Struct.)	Data Type	Description
			Preemption Active	BOOL (8)	Allows a link partner to know if link preemption has passed embedded verification. 0 = Not Active 1 = Active
			Additional Fragment Size	USINT (8)	The number of octets that must be transmitted of a frame before preemption occur. 0 = 64 octets 1 = 128 octets 2 = 192 octets 3 = 256 octets 4-255 = Reserved
9	Get	Last Change		UDINT (32)	The value of sysUpTime taken the last time any attribute in this instance changed.

Common Service

Service Code	Implementation		Service Name	Description
	Class	Instance		
0x01	✓		Get_Attribute_All	Returns the contents of all attributes of the class.
0x0E	✓	✓	Get_Attribute_Single	Used to read an object instance attribute.
0x11	✓		Find_Next_Object_Instance	Causes the specified Class to search for and return a list of instances ID's of existing instances of the LLDP Data Table Object.

Moxa Networking Object (Vendor Specific)

The Moxa Networking object includes system information and status.

It can also be used to do the device diagnostic & configuration through explicit messaging.

The class code is **0x404**.

Class Attribute List

Attr ID	Access Rule	Name	Data Type	Description
1	Get	Revision	UINT (16)	Revision of this object

Instance Attribute List

Attr ID	Access Rule	Name	Data Type	Description
1	Get	CPU Usage	USINT (8)	Percentage of CPU usage (0 to100)
2	Get	L2 Redundancy	USINT (8)	Bit mask of device roles. Bit 0: RSTP 0 = RSTP Disabled 1 = RSTP Enabled Bit 1: MSTP 0 = MSTP Disabled 1 = MSTP Enabled Bit 2: Turbo Chain 0 = Turbo Chain Disabled 1 = Turbo Chain Enabled Bit 3: Turbo Ring v2 0 = Turbo Ring v2 Disabled 1 = Turbo Ring v2 Enabled Bit 4: Dual-Homing 0 = Dual-Homing Disabled 1 = Dual-Homing Enabled Bit 5: MRP 0 = MRP Disabled 1 = MRP Enabled

Attr ID	Access Rule	Name	Data Type	Description
3	Get	Relay Alarm Status	USINT (8)	Relay alarm event-triggered status. When Relay alarm is triggered, value will change from 0x0 to 0x1. Bit 0: Relay (MGMT-Relay) alarm status 0 = Alarm doesn't trigger. 1 = Alarm triggered. Bit 1: PWR1-Relay alarm status 0 = Alarm doesn't trigger. 1 = Alarm triggered. Bit 2: PWR2-Relay alarm status 0 = Alarm doesn't trigger. 1 = Alarm triggered.
4	Get/Set	Cold Start	USINT (8)	System cold start event notification. (Bit 1 should call MGMT-Relay if device support more than 1 relay. Bit 2-3 depends on device supported relay number.) Bit 0: Event notification enable. 0 = Disabled 1 = Enabled Bit 1: Relay (MGMT-Relay) alarm enable. 0 = Disabled 1 = Enabled Bit 2: PWR1-Relay alarm enable. 0 = Disabled 1 = Enabled Bit 3: PWR2-Relay alarm enable. 0 = Disabled 1 = Enabled
5	Get/Set	Warm Start	USINT (8)	System warm start event notification. (Bit 1 should call MGMT-Relay if device support more than 1 relay. Bit 2-3 depends on device supported relay number.) Bit 0: Event notification enable. 0 = Disabled 1 = Enabled Bit 1: Relay (MGMT-Relay) alarm enable. 0 = Disabled 1 = Enabled Bit 2: PWR1-Relay alarm enable. 0 = Disabled 1 = Enabled Bit 3: PWR2-Relay alarm enable. 0 = Disabled 1 = Enabled
6	Get/Set	Redundant port health check fail	USINT (8)	Redundant port health check fail. (Bit 1 should call MGMT-Relay if device support more than 1 relay. Bit 2-3 depends on device supported relay number.) Bit 0: Event notification enable. 0 = Disabled 1 = Enabled Bit 1: Relay (MGMT-Relay) alarm enable. 0 = Disabled 1 = Enabled Bit 2: PWR1-Relay alarm enable. 0 = Disabled 1 = Enabled Bit 3: PWR2-Relay alarm enable. 0 = Disabled 1 = Enabled

Attr ID	Access Rule	Name	Data Type	Description
7	Get/Set	PD over current	USINT (8)	<p>Current of port has exceeded the safety limit. (Bit 1 should call MGMT-Relay if device support more than 1 relay. Bit 2-3 depends on device supported relay number.)</p> <p>Bit 0: Event notification enable. 0 = Disabled 1 = Enabled</p> <p>Bit 1: Relay (MGMT-Relay) alarm enable. 0 = Disabled 1 = Enabled</p> <p>Bit 2: PWR1-Relay alarm enable. 0 = Disabled 1 = Enabled</p> <p>Bit 3: PWR2-Relay alarm enable. 0 = Disabled 1 = Enabled</p>
8	Get/Set	PD no response	USINT (8)	<p>The device connected to this port is not responding to the PD failure check. (Bit 1 should call MGMT-Relay if device support more than 1 relay. Bit 2-3 depends on device supported relay number.)</p> <p>Bit 0: Event notification enable. 0 = Disabled 1 = Enabled</p> <p>Bit 1: Relay (MGMT-Relay) alarm enable. 0 = Disabled 1 = Enabled</p> <p>Bit 2: PWR1-Relay alarm enable. 0 = Disabled 1 = Enabled</p> <p>Bit 3: PWR2-Relay alarm enable. 0 = Disabled 1 = Enabled</p>
9	Get/Set	Power On	USINT (8)	<p>Power supply on event notification. (Bit 1 should call MGMT-Relay if device support more than 1 relay. Bit 2-3 depends on device supported relay number.)</p> <p>Bit 0: Event notification enable. 0 = Disabled 1 = Enabled</p> <p>Bit 1: Relay (MGMT-Relay) alarm enable. 0 = Disabled 1 = Enabled</p> <p>Bit 2: PWR1-Relay alarm enable. 0 = Disabled 1 = Enabled</p> <p>Bit 3: PWR2-Relay alarm enable. 0 = Disabled 1 = Enabled</p>

Attr ID	Access Rule	Name	Data Type	Description
10	Get/Set	Power Off	USINT (8)	<p>Power supply off event notification. (Bit 1 should call MGMT-Relay if device support more than 1 relay. Bit 2-3 depends on device supported relay number.)</p> <p>Bit 0: Event notification enable. 0 = Disabled 1 = Enabled</p> <p>Bit 1: Relay (MGMT-Relay) alarm enable. 0 = Disabled 1 = Enabled</p> <p>Bit 2: PWR1-Relay alarm enable. 0 = Disabled 1 = Enabled</p> <p>Bit 3: PWR2-Relay alarm enable. 0 = Disabled 1 = Enabled</p>
11	Get/Set	DI on	USINT (8)	<p>Digital input on event notification. (Bit 1 should call MGMT-Relay if device support more than 1 relay. Bit 2-3 depends on device supported relay number.)</p> <p>Bit 0: Event notification enable. 0 = Disabled 1 = Enabled</p> <p>Bit 1: Relay (MGMT-Relay) alarm enable. 0 = Disabled 1 = Enabled</p> <p>Bit 2: PWR1-Relay alarm enable. 0 = Disabled 1 = Enabled</p> <p>Bit 3: PWR2-Relay alarm enable. 0 = Disabled 1 = Enabled</p>
12	Get/Set	DI off	USINT (8)	<p>Digital input off event notification. (Bit 1 should call MGMT-Relay if device support more than 1 relay. Bit 2-3 depends on device supported relay number.)</p> <p>Bit 0: Event notification enable. 0 = Disabled 1 = Enabled</p> <p>Bit 1: Relay (MGMT-Relay) alarm enable. 0 = Disabled 1 = Enabled</p> <p>Bit 2: PWR1-Relay alarm enable. 0 = Disabled 1 = Enabled</p> <p>Bit 3: PWR2-Relay alarm enable. 0 = Disabled 1 = Enabled</p>

Attr ID	Access Rule	Name	Data Type	Description
13	Get/Set	Port On	USINT (8)	<p>Port link up event notification. (Bit 1 should call MGMT-Relay if device support more than 1 relay. Bit 2-3 depends on device supported relay number.)</p> <p>Bit 0: Event notification enable. 0 = Disabled 1 = Enabled</p> <p>Bit 1: Relay (MGMT-Relay) alarm enable. 0 = Disabled 1 = Enabled</p> <p>Bit 2: PWR1-Relay alarm enable. 0 = Disabled 1 = Enabled</p> <p>Bit 3: PWR2-Relay alarm enable. 0 = Disabled 1 = Enabled</p>
14	Get/Set	Port Off	USINT (8)	<p>Port link down event notification. (Bit 1 should call MGMT-Relay if device support more than 1 relay. Bit 2-3 depends on device supported relay number.)</p> <p>Bit 0: Event notification enable. 0 = Disabled 1 = Enabled</p> <p>Bit 1: Relay (MGMT-Relay) alarm enable. 0 = Disabled 1 = Enabled</p> <p>Bit 2: PWR1-Relay alarm enable. 0 = Disabled 1 = Enabled</p> <p>Bit 3: PWR2-Relay alarm enable. 0 = Disabled 1 = Enabled</p>
15	Get/Set	Port shutdown by Port Security	USINT (8)	<p>Port shutdown by Port Security event notification. (Bit 1 should call MGMT-Relay if device support more than 1 relay. Bit 2-3 depends on device supported relay number.)</p> <p>Bit 0: Event notification enable. 0 = Disabled 1 = Enabled</p> <p>Bit 1: Relay (MGMT-Relay) alarm enable. 0 = Disabled 1 = Enabled</p> <p>Bit 2: PWR1-Relay alarm enable. 0 = Disabled 1 = Enabled</p> <p>Bit 3: PWR2-Relay alarm enable. 0 = Disabled 1 = Enabled</p>

Attr ID	Access Rule	Name	Data Type	Description
16	Get/Set	Port shutdown by Rate Limit	USINT (8)	<p>Port shutdown by Rate Limit event notification. (Bit 1 should call MGMT-Relay if device support more than 1 relay. Bit 2-3 depends on device supported relay number.)</p> <p>Bit 0: Event notification enable. 0 = Disabled 1 = Enabled</p> <p>Bit 1: Relay (MGMT-Relay) alarm enable. 0 = Disabled 1 = Enabled</p> <p>Bit 2: PWR1-Relay alarm enable. 0 = Disabled 1 = Enabled</p> <p>Bit 3: PWR2-Relay alarm enable. 0 = Disabled 1 = Enabled</p>
17	Get/Set	Port recovered by Rate Limit	USINT (8)	<p>Port recovered by Rate Limit event notification. (Bit 1 should call MGMT-Relay if device support more than 1 relay. Bit 2-3 depends on device supported relay number.)</p> <p>Bit 0: Event notification enable. 0 = Disabled 1 = Enabled</p> <p>Bit 1: Relay (MGMT-Relay) alarm enable. 0 = Disabled 1 = Enabled</p> <p>Bit 2: PWR1-Relay alarm enable. 0 = Disabled 1 = Enabled</p> <p>Bit 3: PWR2-Relay alarm enable. 0 = Disabled 1 = Enabled</p>
18	Get/Set	Fiber Check Warning	USINT (8)	<p>Fiber check warning event notification. (Bit 1 should call MGMT-Relay if device supports more than 1 relay. Bit 2-3 depends on device supported relay number.)</p> <p>Bit 0: Event notification enable. 0 = Disabled 1 = Enabled</p> <p>Bit 1: Relay (MGMT-Relay) alarm enable. 0 = Disabled 1 = Enabled</p> <p>Bit 2: PWR1-Relay alarm enable. 0 = Disabled 1 = Enabled</p> <p>Bit 3: PWR2-Relay alarm enable. 0 = Disabled 1 = Enabled</p>
19	Set	Relay Alarm Cut-off	USINT (8)	<p>Cut off the relay alarm. (Bit 0 should call MGMT-Relay if device support more than 1 relay. Bit 1-2 depends on device supported relay number.)</p> <p>Bit 0: Relay (MGMT-Relay) 0 = Don't cut-off relay 1 = Cut-off relay</p> <p>Bit 1: PWR1-Relay 0 = Don't cut-off relay 1 = Cut-off relay</p> <p>Bit 2: PWR2-Relay 0 = Don't cut-off relay 1 = Cut-off relay</p>

Attr ID	Access Rule	Name	Data Type	Description
20	Set	Reset MIB Count	USINT (8)	Reset port MIB counters. (Ethernet Link object's attributes 4-5 and 12-13.) Any value indicates to reset port MIB counter.
21	Set	Reset Device	USINT (8)	Reboot and reset to default 0 = Reserved. 1 = Reboot the device 2 = Reset to default

Common Service List

Service Code	Implementation		Service Name	Description
	Class	Instance		
0x0E	✓	✓	Get_Attribute_Single	Used to read an object instance attribute
0x10		✓	Set_Attribute_Single	Used to modify an object instance attribute

Electronic Data Sheet (EDS) File

The EDS (Electronic Data Sheet) file contains electronic descriptions of all relevant communication parameters and objects of an EtherNet/IP device. It is required for RSLogix 5000 to recognize Moxa switch and its CIP capability.

The list includes the sections which are described in our EDS file.

- [File]
- [Device]
- [Device Classification]
- [Assembly]
- [Connection Manager]
- [Port]
- [Ethernet Link Class]

Icon should be 32 * 32 in pixel.

Rockwell RSLogix 5000 Add-On Instructions (AOI)

The Rockwell RSLogix 5000 Add-On Instructions (AOI) encapsulates Moxa switch supported EtherNet/IP functions in a common interface logic component. In RSLogix 5000 programming, users could use the AOI to communicate with Moxa switches and need not know the internal logic.

Our AOI would provide logic of Moxa switch configuration and monitoring by using EtherNet/IP in explicit messaging and implicit messaging. The AOI also provides some tags for RSLogix 5000/SCADA programming.

AOI Installation

To install the AOI, you must use Rockwell RSLogix 5000 version 18 or later and Moxa managed Ethernet switches with firmware version 3.0 or later.

The Five Major Stages of Installing the AOI

1. Add Moxa switch to the I/O configuration tree
2. Import the Add-On Instruction (AOI)
3. Add an instance of the AOI in your application
4. Create and configure tags for the AOI
5. Download the configured AOI to Rockwell PLC

Add Moxa switch to the I/O configuration tree

In order to import the AOI, the first step is to create a new Ethernet Module in RSLogix 5000.

1. Open RSLogix 5000 and create a new controller.

Click **Type** and select the Rockwell PLC model of the PLC connected to the Moxa switch. Input a **Name** and **Description** for this new controller.

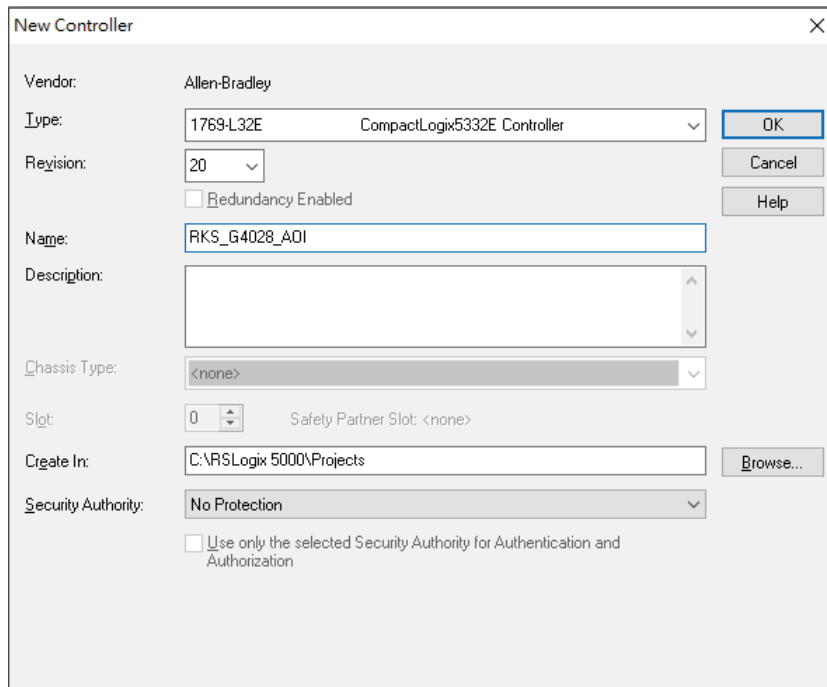

2. Add an Ethernet Module to the I/O Configuration.

In the controller organizer window, select **I/O Configuration**, right click **Ethernet** under the PLC Ethernet port of the PLC connected to a Moxa switch, and select **New Module**.

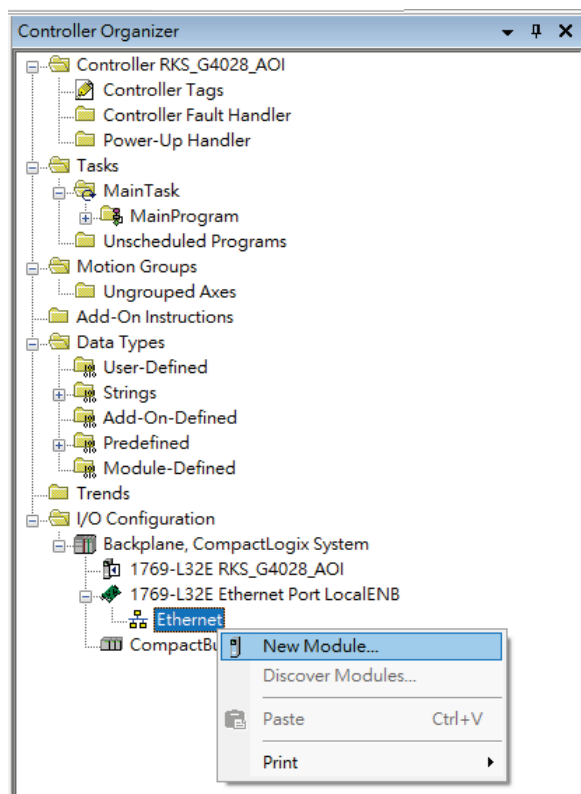

- Under the **Communications** group, select **Generic Ethernet Module** to represent Moxa Ethernet switches.

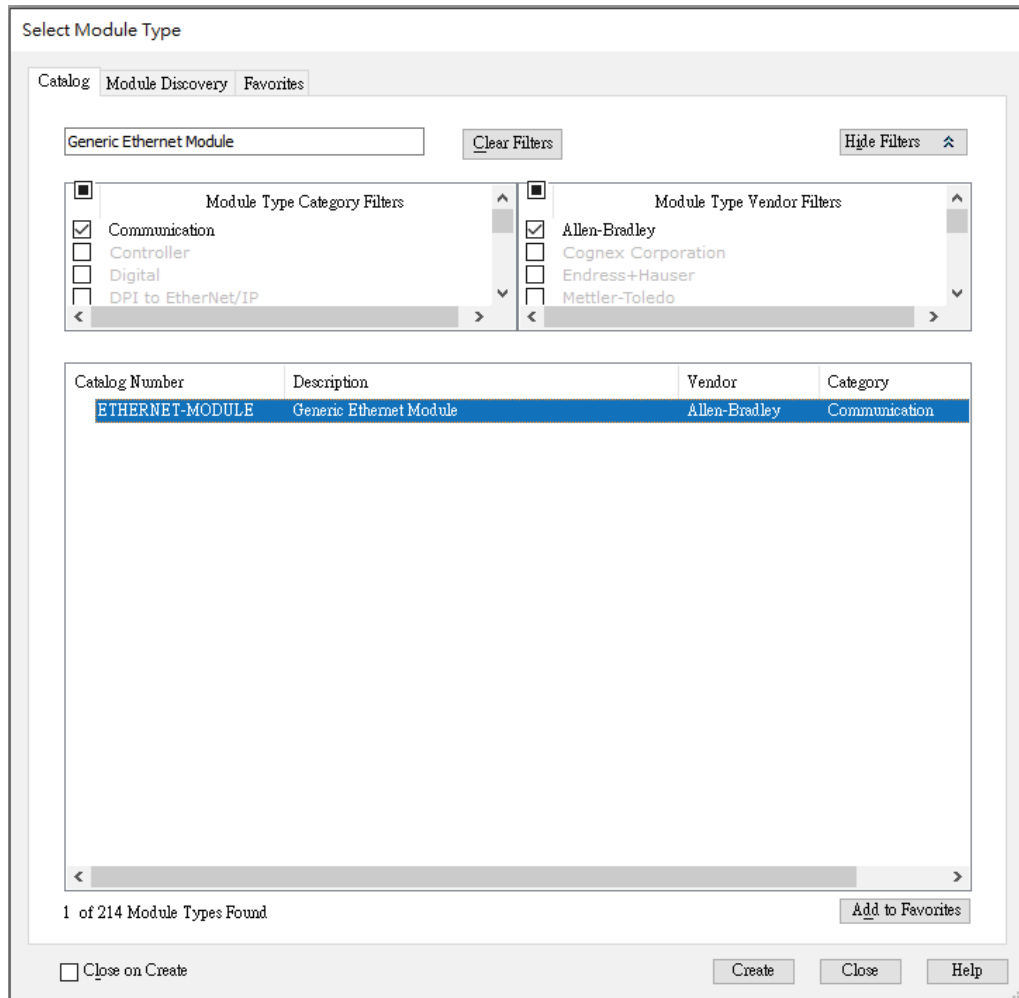

- Configure the Ethernet module with the correct name, description, IP address and connection parameters and click **OK**.

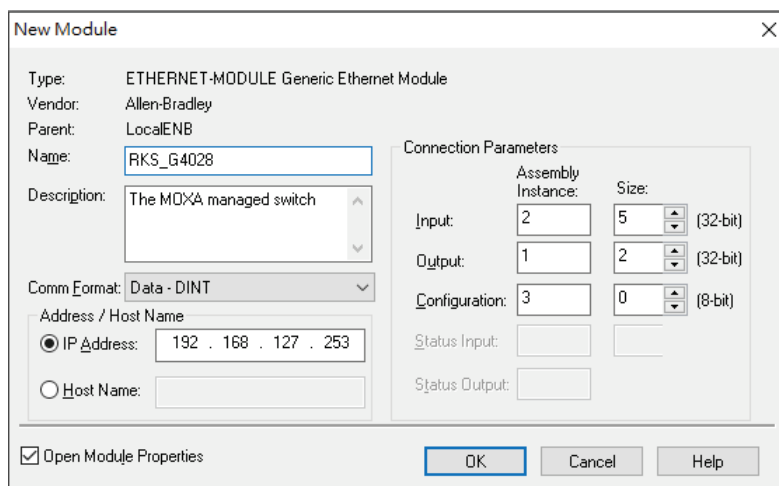

- After finishing configuration, the new Ethernet module representing the Moxa Ethernet switch will appear under the **I/O Configuration** list in the controller organizer window.

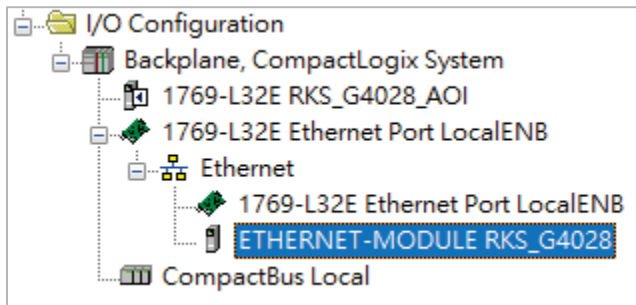

Import the Add-On Instruction (AOI)

- In the controller organizer window, right click the **Add-On Instructions** folder, select **Import Add-On Instructions** and select the correct AOI file (xxx.L5X) to import.



NOTE

The AOI file is available from the Moxa website. Please make sure to use the latest switch firmware and AOI for programming.

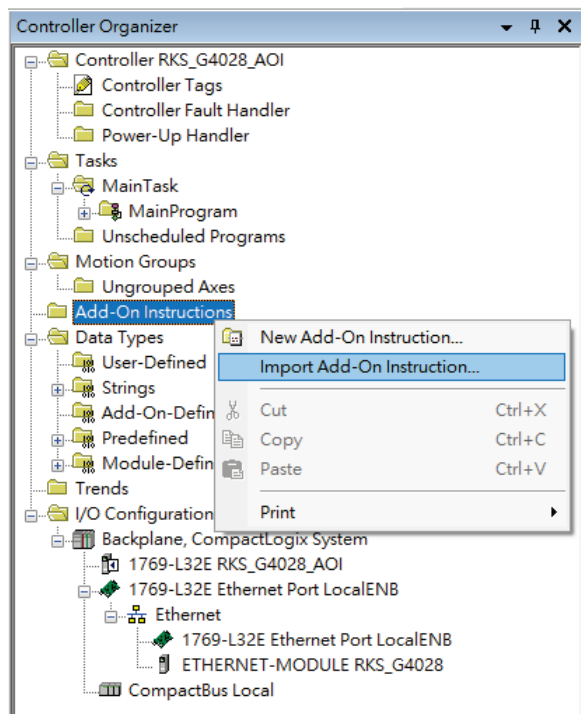

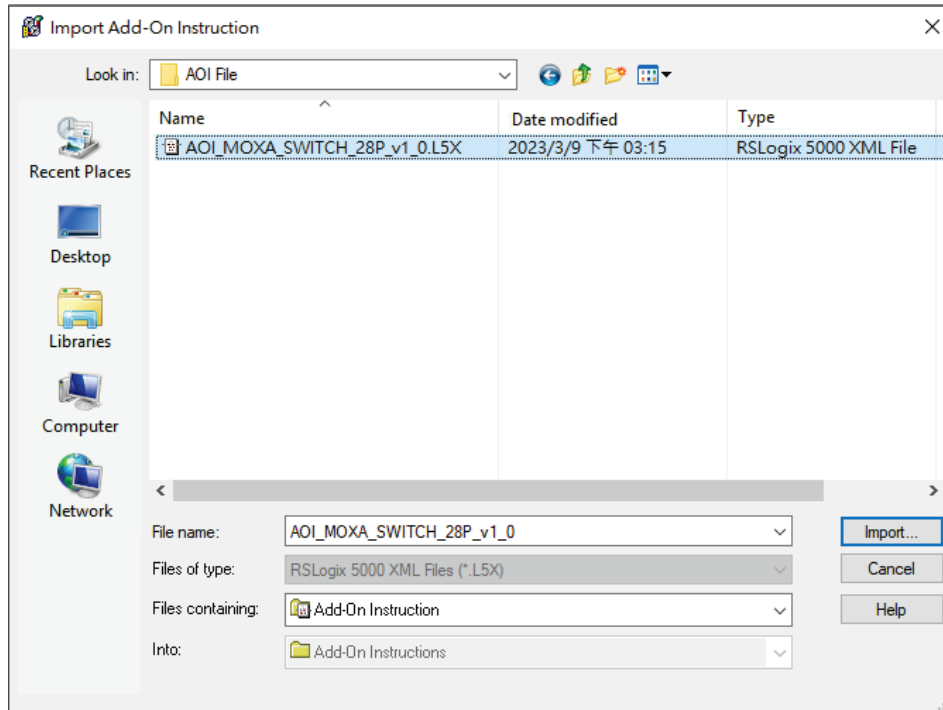

2. After importing, the controller organizer window shows all AOI for Moxa Ethernet switches under the **Add-On Instructions** folder.

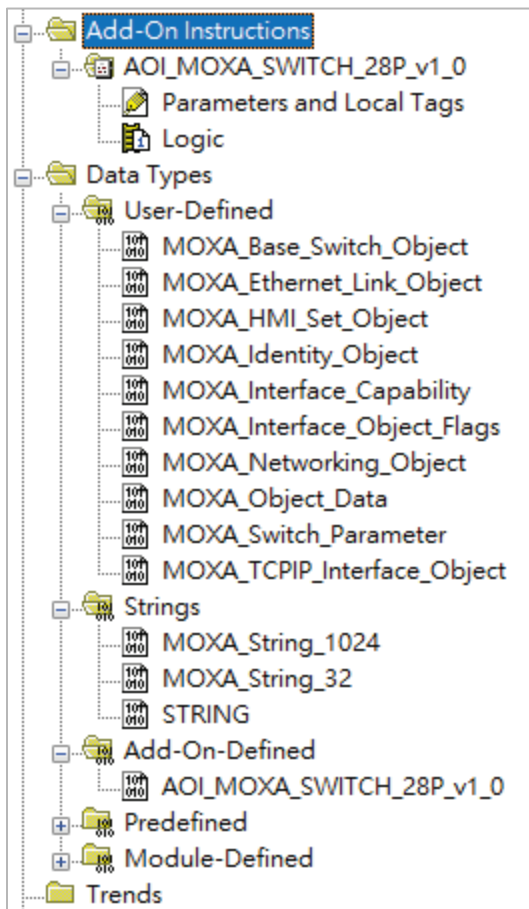

Add an instance of the AOI in your application

Double click the **MainRoutine** in the Controller Organizer to start the ladder programming. Add the AOI for the specific Moxa Ethernet switch to create a new rung.

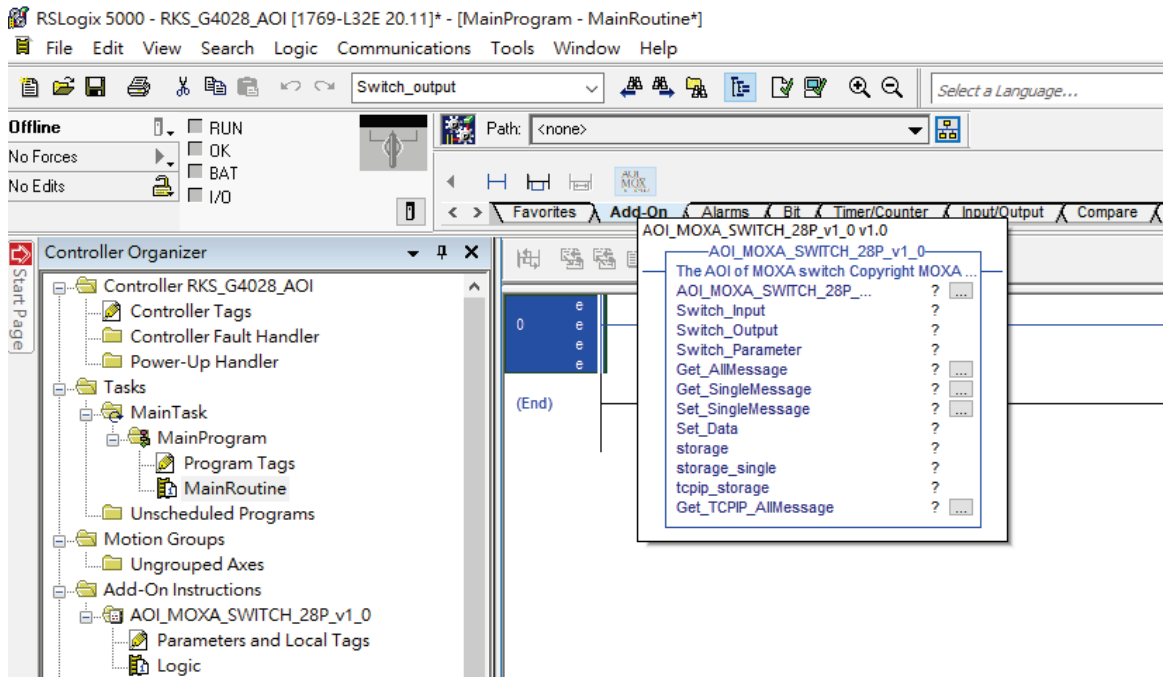

Create and configure tags for the AOI

1. Right click on the ? in the field of each tag, select **New Tag** and input a **Name** for each new tag.

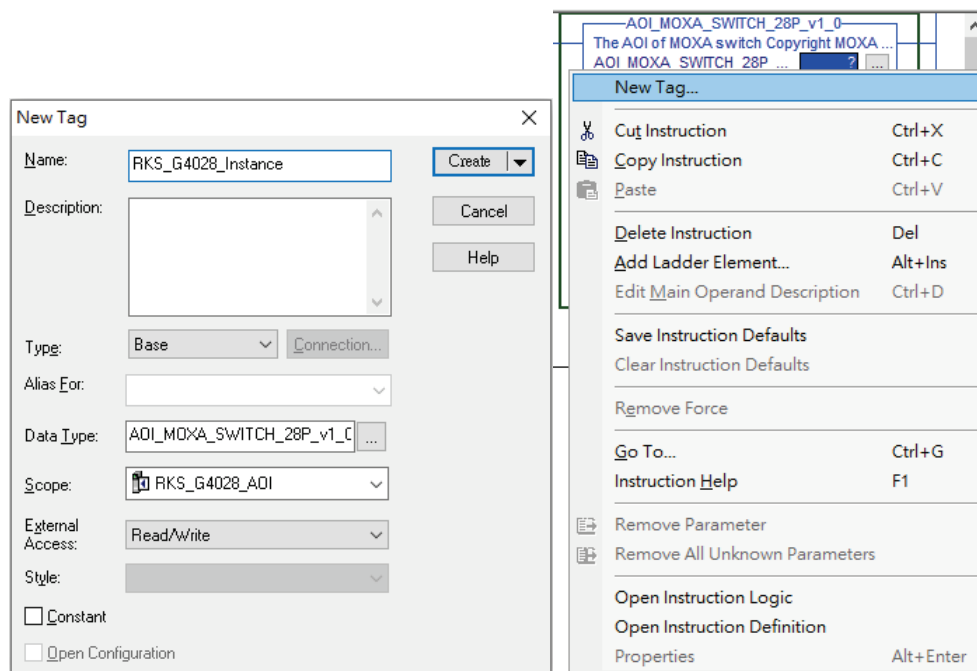

2. Add a **Name** for all AOI tags.

The AOI of MOXA switch
Copyright MOXA Corp.
2023 Version: 1.0
Date: Feb 13, 2023

—AOI_MOXA_SWITCH_28P_v1_0—

The AOI of MOXA switch Copyright MOXA Corp. 2023 V...
AOI_MOXA_SWITCH_28P_... RKS_G4028_Instance ...
Switch_Input RKS_G4028:I.Data
Switch_Output RKS_G4028:O.Data
Switch_Parameter moxa_param
Get_AllMessage MOXA_GetAll ...
Get_SingleMessage MOXA_GetSingle ...
Set_SingleMessage MOXA_SetSingle ...
Set_Data MOXA_SetData
storage MOXA_AllStorage
storage_single MOXA_SingleStorage
tcpip_storage MOXA_TCPIPstorage
Get_TCPIP_AllMessage MOXA_TCPIP_GetAll ...

The AOI of MOXA switch
Copyright MOXA Corp.
2023 Version: 1.0
Date: Feb 13, 2023

—AOI_MOXA_SWITCH_28P_v1_0—

The AOI of MOXA switch Copyright MOXA Corp. 2023 V...
AOI_MOXA_SWITCH_28P_... RKS_G4028_Instance ...
Switch_Input RKS_G4028:I.Data
Switch_Output

Y. Enter Name Filter... Show: All Tags

Name	Data Type
MOXA_SetSingle	MESSAGE
MOXA_SingleStorage	SINT[200]
MOXA_TCPIPstorage	SINT[200]
RKS_G4028:C	AB:ETHERNET_MODULE:C:0
RKS_G4028:I	AB:ETHERNET_MODULE_DINT_20Bytes:1:0
RKS_G4028:I.Data	DINT[5]
RKS_G4028:O	AB:ETHERNET_MODULE_DINT_8Bytes:0:0
RKS_G4028_Instance	AOI_MOXA_SWITCH_28P_v1_0

Controller
Program

The AOI of MOXA switch
Copyright MOXA Corp.
2023 Version: 1.0
Date: Feb 13, 2023

—AOI_MOXA_SWITCH_28P_v1_0—

The AOI of MOXA switch Copyright MOXA Corp. 2023 V...
AOI_MOXA_SWITCH_28P_... RKS_G4028_Instance ...
Switch_Input RKS_G4028:I.Data
Switch_Output RKS_G4028:O.Data
Switch_Parameter

Y. Enter Name Filter... Show: All Tags

Name	Data Type
MOXA_SetSingle	MESSAGE
MOXA_SingleStorage	SINT[200]
MOXA_TCPIPstorage	SINT[200]
RKS_G4028:C	AB:ETHERNET_MODULE:C:0
RKS_G4028:I	AB:ETHERNET_MODULE_DINT_20Bytes:1:0
RKS_G4028:O	AB:ETHERNET_MODULE_DINT_8Bytes:0:0
RKS_G4028:O.Data	DINT[2]
RKS_G4028_Instance	AOI_MOXA_SWITCH_28P_v1_0

Controller
Program

For “Switch_Input” and “Switch_Output”, use the scrollbar to select the tag name.

For all other tags, manually type the tag names:

AOI Tag	Reference Tag Name
AOI_MOXA_SWITCH-28P_	RKS_G4028_Instance
Switch_Input	RKS_G4028:I.Data
Switch_Output	RKS_G4028:O.Data
Switch_Parameter	moxa_param
Get_AllMessage	MOXA_GetAll
Get_SingleMessage	MOXA_GetSingle
Set_SingleMessage	MOXA_SetSingle
Set_Data	MOXA_SetData
storage	MOXA_AllStorage
storage_single	MOXA_SingleStorage
tcpip_storage	MOXA_TCPIPstorage
Get_TCPIP_AllMessage	MOXA_TCPIP_GetAll

Switch_Output represents "Global Port Admin State". The default value of Switch_Output data is 0. When the switch receives 0 as Switch_Output data, the port will shutdown according to the ODVA standard. To avoid the port shutting down in the first place, we suggest setting Switch_Output data as 0xffffffff ffffffff.

Right Click or double click RKS_G4028L:O.Data on Controller Tags to select **Monitor Tags**.

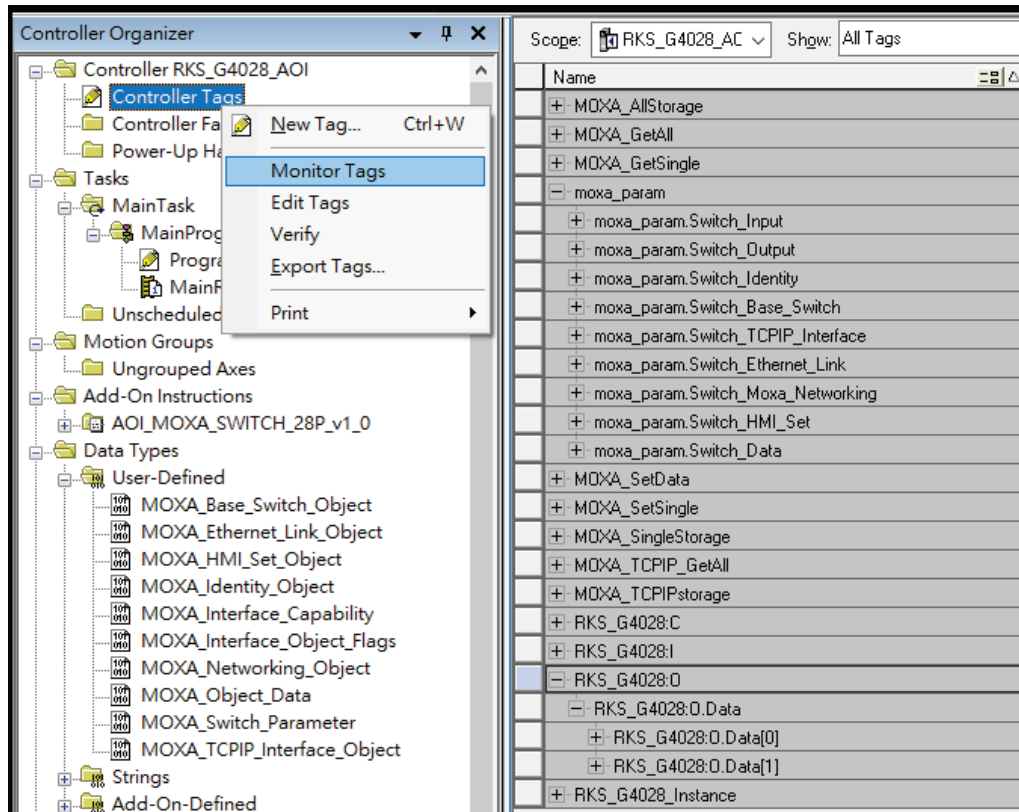

Then, set all of the O.Data value as 1 (0xFFFFFFFF FFFFFFFF).

+ RKS_G4028:I	{...}	{...}		AB:ETHERNET_MOD...
- RKS_G4028:O	{...}	{...}		AB:ETHERNET_MOD...
- RKS_G4028:O.Data	{...}	{...}		
+ RKS_G4028:O.Data[0]	16#ffff_ffff		Decimal	DINT[2]
+ RKS_G4028:O.Data[1]	16#ffff_ffff		Hex	DINT

- Click the square button to the right of the **Get_AllMessage** tag and configure all parameters as follows:

(Service Code: 1; Class: 1; Instance: 1; Attribute: 1; Destination: MOXA_allstorage[0])

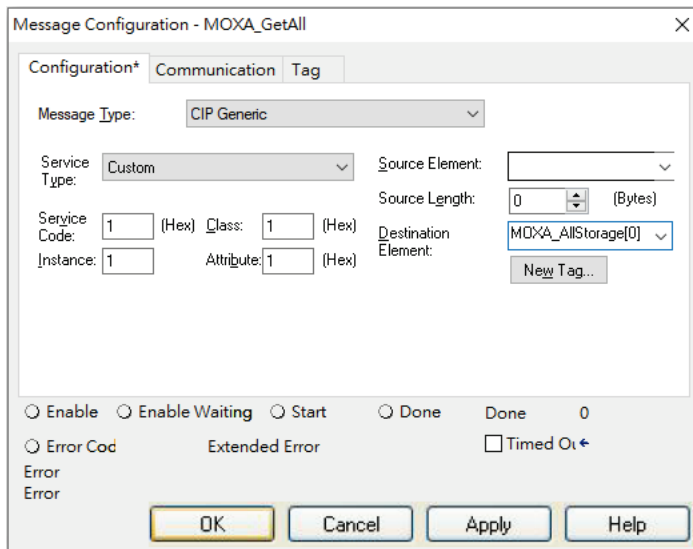

Click the **Communication** tab and set up the communication path to the Moxa Ethernet switch for **Get_AllMessage**.

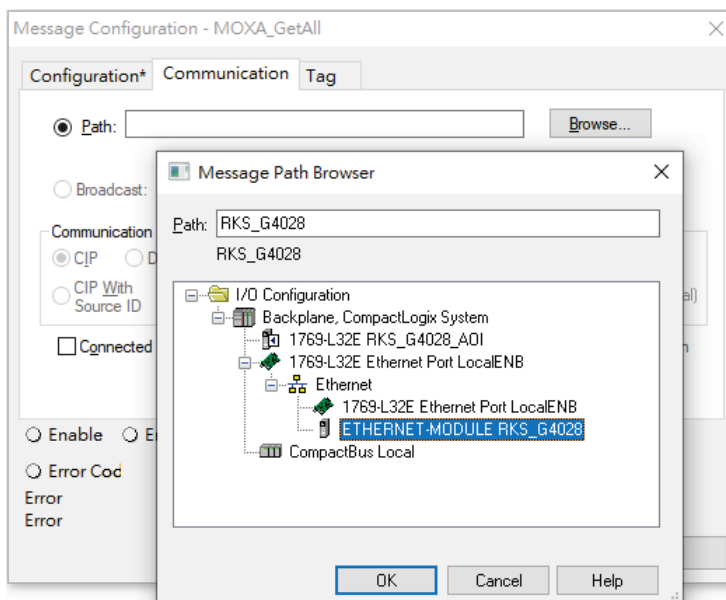

- Click the square button to the right of the **Set_Message** tag and configure all parameters as follows:
(Service Code: 10; Class: f6; Instance: 1; Attribute: 1; Source Ethernet: MOXA_SetData)

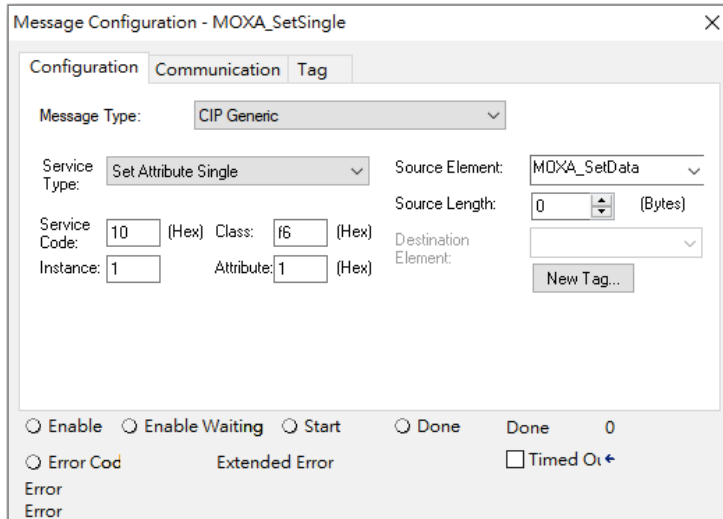

Click the **Communication** tab and set up the communication path to the Moxa Ethernet switch for **Set_Message**.

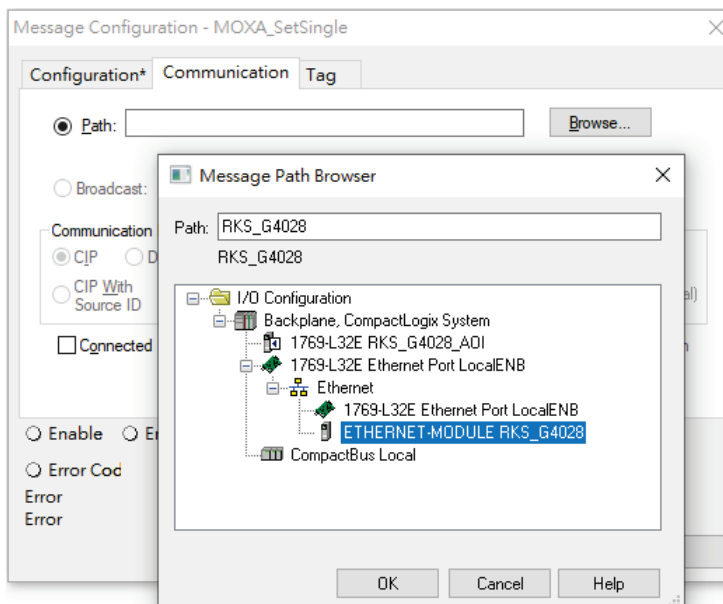

- Click the square button to the right of the **Get_SingMessage** tag and configure all parameters as follows:

(Service Code: e; Class: f6; Instance: 1; Attribute: 1; Destination: MOXA_SingleStorage[0])

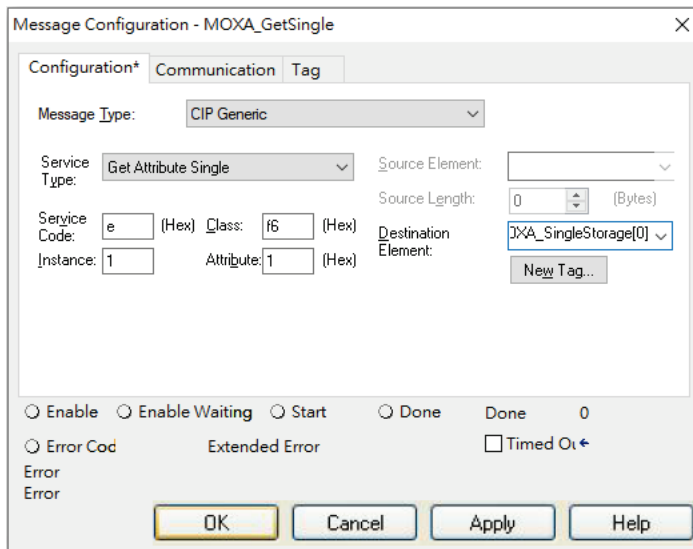

Click the **Communication** tab and set up the communication path to the Moxa Ethernet switch for **Get_SingMessage**.

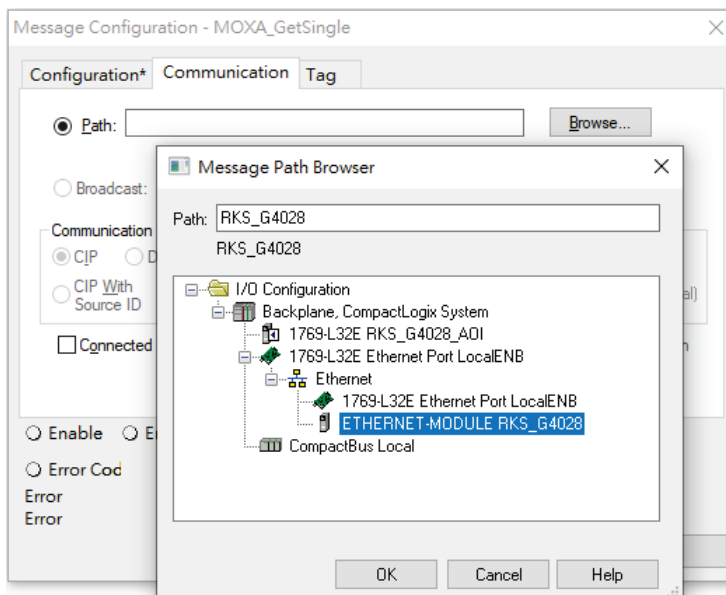

- Click the square button to the right of the **Get_TCPIP_AllMessage** tag and configure all parameters as follows:

(Service Code: 1; Class: f5; Instance: 1; Attribute: 1; Destination: MOXA_TCPIPstorage[0])

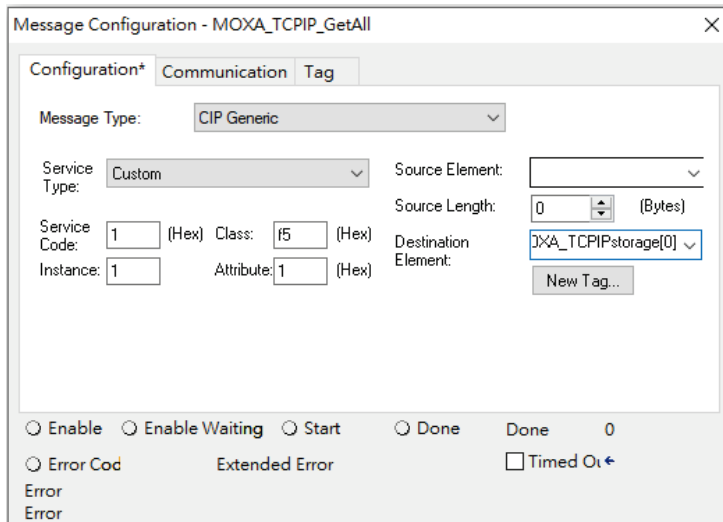

Click the Communication tab and set up the communication path to the Moxa Ethernet switch for **Get_TCPIP_AllMessage**.

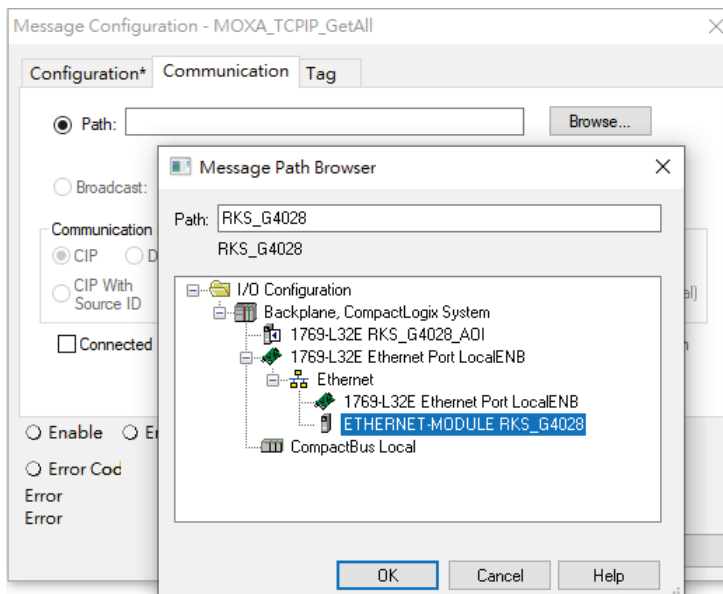

Download the configured AOI to the Rockwell PLC

1. Click the **Network** Icon, select the Rockwell PLC connected to the Moxa switch and click **Download** to install the AOI configuration to the PLC.

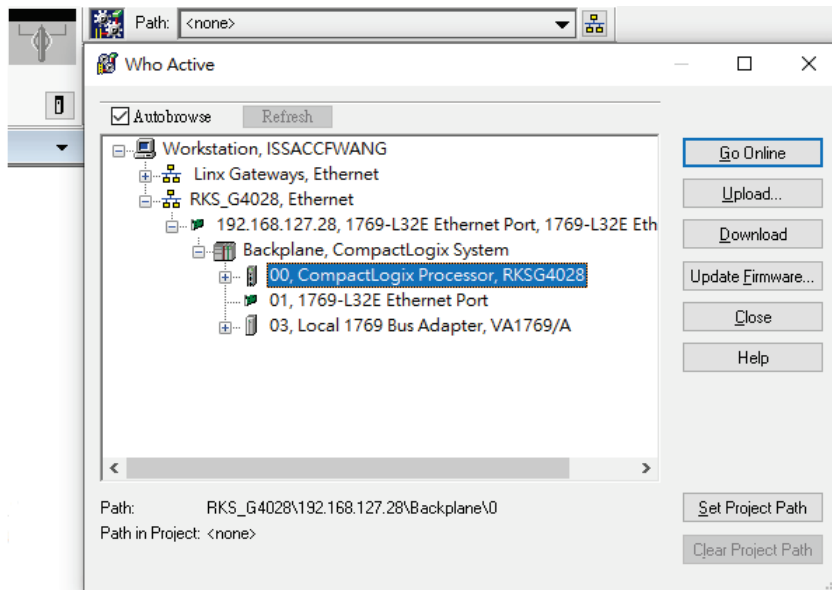

2. After finishing configuration, go to the controller organizer window, right click **Controller Tags** and select **Monitor Tags** to check if each tag can display the correct value transferred from the Ethernet device.

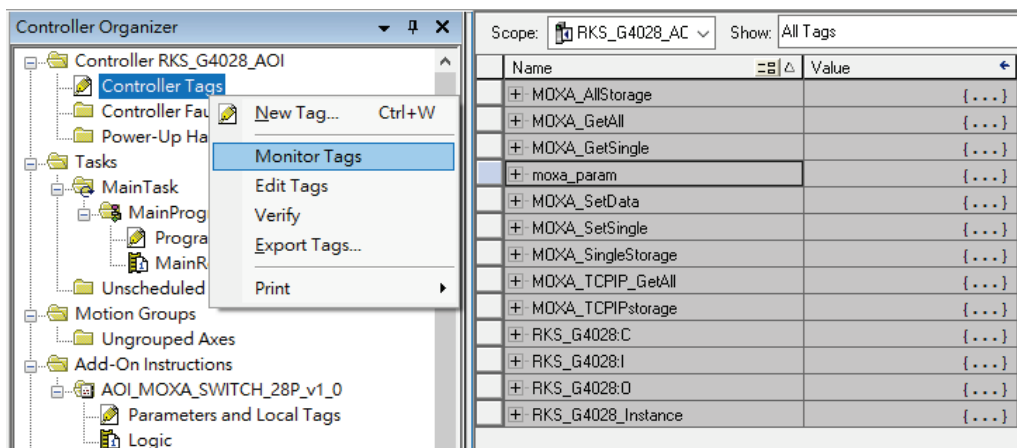

Scope: RKS_G4028_AC		Show: All Tags		
Name	Value	Force Mask	Style	Data Type
MOXA_AllStorage	{...}	{...}	Decimal	SINT[200]
MOXA_GetAll	{...}	{...}		MESSAGE
MOXA_GetSingle	{...}	{...}		MESSAGE
moxa_param	{...}	{...}		MOXA_Switch_Param...
moxa_param.Switch_Input	{...}	{...}	Hex	DINT[5]
moxa_param.Switch_Output	{...}	{...}	Hex	DINT[2]
moxa_param.Switch_Identity	{...}	{...}		MOXA_Identity_Object
moxa_param.Switch_Identity.Vendor_ID	16#03df		Hex	INT
moxa_param.Switch_Identity.Device_Type	16#002c		Hex	INT
moxa_param.Switch_Identity.Product_Code	16#2301		Hex	INT
moxa_param.Switch_Identity.Major_Revision	1		Decimal	SINT
moxa_param.Switch_Identity.Minor_Revision	1		Decimal	SINT
moxa_param.Switch_Identity.Status	16#0060		Hex	INT
moxa_param.Switch_Identity.Serial_Number	16#0000_0000		Hex	DINT
moxa_param.Switch_Identity.Product_Name	'RKS-G4028-L3-4GT-HV'	{...}		STRING
moxa_param.Switch_Identity.Assigned_Name	''	{...}		MOXA_String_1024
moxa_param.Switch_Identity.Geographic_Location	''	{...}		MOXA_String_1024
moxa_param.Switch_Base_Switch	{...}	{...}		MOXA_Base_Switch_...
moxa_param.Switch_TCPIP_Interface	{...}	{...}		MOXA_TCPIP_Interfac...
moxa_param.Switch_TCPIP_Interface.Status	16#0000_0001		Hex	DINT
moxa_param.Switch_TCPIP_Interface.Configuration_C...	16#0000_0016		Hex	DINT
moxa_param.Switch_TCPIP_Interface.Configuration_C...	16#0000_0000		Hex	DINT
moxa_param.Switch_TCPIP_Interface.Path_Size	2		Decimal	INT
moxa_param.Switch_TCPIP_Interface.Object_Path	16#0124_f620		Hex	DINT
moxa_param.Switch_TCPIP_Interface.IP_Address	16#c0a8_7ffd		Hex	DINT
moxa_param.Switch_TCPIP_Interface.Network_Mask	16#ffff_ff00		Hex	DINT
moxa_param.Switch_TCPIP_Interface.Gateway_Address	16#0000_0000		Hex	DINT
moxa_param.Switch_TCPIP_Interface.Name_Server_1	16#0000_0000		Hex	DINT
moxa_param.Switch_TCPIP_Interface.Name_Server_2	16#0000_0000		Hex	DINT
moxa_param.Switch_TCPIP_Interface.Domain_Name	''	{...}		STRING
moxa_param.Switch_TCPIP_Interface.Host_Name	'moxa'	{...}		STRING
moxa_param.Switch_TCPIP_Interface.Encapsulation_L...	120		Decimal	INT
moxa_param.Switch_Ethernet_Link	{...}	{...}		MOXA_Ethernet_Link_...
moxa_param.Switch_Moxa_Networking	{...}	{...}		MOXA_Networking_O...
moxa_param.Switch_HMI_Set	{...}	{...}		MOXA_HMI_Set_Object
moxa_param.Switch_Data	{...}	{...}		MOXA_Object_Data



NOTE

Only Moxa pre-configured tags will display the correct values. Refer to the CIP Tags section below for detailed information.

CIP Tags

There are tags for each CIP object. The tags correspond to the object's attributes.

Tags for Identity Object

Data Type: MOXA_Identity_Object

Name	Data Type	Description
Vendor ID	INT	ODVA Vendor ID. Moxa=0x3DF
Device Type	INT	0x2C, "Managed Ethernet Switch"
Product Code	INT	Refer to the Product Code Table. Example: RKS-G4028-4GT-HV = 0x1301
Major Revision	SINT	The structure member, major
Minor Revision	SINT	The structure member, minor
Status	INT	Summary status of the device
Serial Number	DINT	Switch serial number
Product Name	STRING	Switch model name
Assigned Name	MOXA_String	User assigned switch name
Geographic Location	MOXA_String	User assigned switch location

Tags for TCP/IP Object

Data Type: MOXA_TCPIP_Interface_Object

Name	Data Type	Description
Status	DINT	Interface status
Configuration Capability	DINT	Interface capability flags
Configuration Control	DINT	Interface control flags
Path Size	INT	Size of Path
Object Path 1	INT	Logical segments identifying the physical link object
Object Path 2	INT	Logical segments identifying the physical link object
IP Address	DINT	The device's IP address
Network Mask	DINT	The device's network mask
Gateway Address	DINT	Default gateway address
Name Server 1	DINT	Primary name server
Name Server 2	DINT	Secondary name server
Domain Name	STRING	Default domain name
Host Name	STRING	Host name
Encapsulation Inactivity Timeout	INT	Number of seconds of inactivity before TCP connection closes.

Tags for Ethernet Link Object

Data Type: MOXA_Ethernet_Link_Object

Name	Data Type	Description
Interface Speed	DINT	Interface speed currently in use. Speed in Mbps (e.g., 0, 10, 100, 1000, etc.)
Interface Flags	MOXA_Interface_Object_Flags_v0	Interface status flags
Physical Address	SINT[6]	MAC layer address
InOctets	DINT	Octets received on the interface
InUcastPackets	DINT	Unicast packets received on the interface
InNucastPackets	DINT	Non-unicast packets received on the interface
InDiscards	DINT	Inbound packets received on the interface but discarded
InErrors	DINT	Inbound packets that contain errors (does not include In Discards)
OutOctets	DINT	Octets sent on the interface
OutUcastPackets	DINT	Unicast packets sent on the interface

Name	Data Type	Description
OutNucastPackets	DINT	Non-unicast packets sent on the interface
OutDiscards	DINT	Outbound packets discarded
OutErrors	DINT	Outbound packets that contain errors
Alignment Errors	DINT	Frames received that are not an integral number of octets in length
FCS Errors	DINT	Frames received that do not pass the FCS check
Single Collisions	DINT	Successfully transmitted frames which experienced exactly one collision
Multiple Collisions	DINT	Successfully transmitted frames which experienced more than one collision
SQE Test Errors	DINT	Number of times SQE test error message is generated
Deferred Transmissions	DINT	Frames for which first transmission attempt is delayed because the medium is busy
Late Collisions	DINT	Number of times a collision is detected later than 512 bit-times into the transmission of a packet
Excessive Collisions	DINT	Frames for which transmission fails due to excessive collisions
MAC Transmit Errors	DINT	Frames for which transmission fails due to an internal MAC sublayer transmit error
Carrier Sense Errors	DINT	Times that the carrier sense condition was lost or never asserted when attempting to transmit a frame
Frame Too Long	DINT	Frames received that exceed the maximum permitted frame size
MAC Receive Errors	DINT	Frames for which reception on an interface fails due to an internal MAC sublayer receive error
Control Bits	INT	0 Auto-negotiate 0 indicates 802.3 link auto-negotiation is disabled. 1 indicates auto-negotiation is enabled
Forced Interface Speed	INT	Speed at which the interface shall be forced to operate. Speed in Mbps (10, 100, 1000, etc.)
Interface Label	STRING	Label like "TX5"
Capability Bits	DINT	Capability Bits contains an array of bits that indicate whether the interface supports capabilities such as auto-negotiation and auto-MDIX.
Speed Duplex Array	SINT	Number of elements
Interface Speed Duplex Capability	MOXA_Interface	The total number of octets received on the interface. This counter is a 64-bit version of In Octets.
HC InOctets	LINT	Unicast packets received on the interface. This counter is a 64-bit version of In Ucast Packets.
HC InMulticastPkts	LINT	Multicast packets received on the interface.
HC InBroadcastPkts	LINT	Broadcast packets received on the interface.
HC OutOctets	LINT	Octets sent on the interface. This counter is a 64-bit version of Out Octets.
HC OutUcastPkts	LINT	Unicast packets sent on the interface. This counter is a 64-bit version of Out Ucast Packets.
HC OutMulticastPkts	LINT	Multicast packets sent on the interface.
HC OutBroadcastPkts	LINT	Broadcast packets sent on the interface.
HC StatsFCSErrors	LINT	Frames received that are not an integral number of octets in length and do not pass the FCS check. This counter is a 64-bit version of Alignment Errors.
HC StandardMacTransmitErrors	LINT	Frames received that are an integral number of octets in length but do not pass the FCS check. This counter is a 64-bit version of FCS Errors.
HC StatsFrameTooLong	LINT	Frames for which transmission fails due to an internal MAC sublayer transmit error. This counter is a 64-bit version of MAC Transmit Errors.
HC StatsInternalMacReceiveErrors	LINT	Frames received that exceed the maximum permitted frame size. This counter is a 64-bit version of Frame Too Long Errors.

Name	Data Type	Description
HC StatsSymbolErrors	LINT	Frames for which reception on an interface fails due to an internal MAC sublayer receive error. This counter is a 64-bit version of MAC Receive Errors.
Port State	LINT	Switch port state.
Media Type	STRING	Port media type.
Traffic Storm Control	SINT	Traffic storm control enabled.
Port On Event	SINT	Registered port for port on event notification.
Port Off Event	SINT	Registered port for port off event notification.
Port Shutdown by PSEC Event	SINT	Registered port for port shut down by Port Security event notification.
Port Shutdown by Rate Limit Event	SINT	Registered port for port shut down by Rate Limit event notification.
Port Recovery by Rate Limit Event	SINT	Registered port for port recovered by Rate Limit event notification.
Fiber Check Warning Event	SINT	Registered port for fiber check warning event notification.

Tags for Moxa Networking Object

Data Type: MOXA_Networking_Object

Name	Data Type	Description
System Firmware Version	DINT	Switch firmware version
System Fault Status	DINT	Switch fault status
Switch Port Number	SINT	Switch max port number
Port Exist	DINT[2]	Switch per port exist
Port Enable	DINT[2]	Switch per port exist 0:Enable 1:Disable
Port Link Status	DINT[2]	Switch per port link status
IGMP Snooping	SINT	IGMP snooping enable: 0: Disable 1: Enable
Query Interval	DINT	Query Interval range from 20~600 sec
IGMP Enhanced Mode	SINT	IGMP enhanced mode 0: Disable (default) 1: Enable
Relay 1	SINT	Override relay warning setting 0: Disable (default) 1: Enable
Relay 2	SINT	Override relay warning setting 0: Disable (default) 1: Enable
Power 1 Relay Warning	SINT	Power input 1 failure (on → off) 0: Disable (default) 1: Enable(relay 1) 2: Enable(relay 2)
Power 2 Relay Warning	SINT	Power input 2 failure (on → off) 0: Disable (default) 1: Enable(relay 1) 2: Enable(relay 2)
DI 1 Off Relay Warning	SINT	DI 1 (off) 0: disable (default) 1: Enable(relay 1) 2: Enable(relay 2)
DI 1 On Relay Warning	SINT	DI 1 (on) 0: Disable (default) 1: Enable(relay 1) 2: Enable(relay 2)

Name	Data Type	Description
DI 2 Off Relay Warning	SINT	DI 2 (off) 0: Disable (default) 1: Enable(relay 1) 2: Enable(relay 2)
DI 2 On Relay Warning	SINT	DI 2 (on) 0: Disable (default) 1: Enable(relay 1) 2: Enable(relay 2)
Turbo Ring Break Relay Warning	SINT	Turbo Ring Break (Ring Master Only) 0: Disable (default) 1: Enable (relay 1) 2: Enable (relay 2)
CPU Usage	SINT	Percent of usage (0-100)
Device Up Time	DINT	Number of seconds since device was powered up
Reset Mib Counter	SINT	Reset port MIB counters
Redundant Device Mode	DINT	Bit 0: RSTP, Bit 1: Turbo Ring, Bit 2: Turbo Ring v2, Bit 3: Turbo Chain, Bit 4: MSTP
Reset Device	SINT	1: restart the device 2: reset to default

Tags for Moxa Base Switch Object

Data Type: MOXA_Base_Switch_Object

Name	Data Type	Description
Device Up Time	DINT	Time since device was powered up.
Total Port Count	DINT	Number of physical available ports.
System Firmware Version	STRING	System Firmware Version.
Power Source	INT	Status of switch power source.
Port Mask Size	INT	Number of DWORDs in port array attributes.
Existing Port	DINT (4)	Switch existing port.
Global Port Admin State	DINT (4)	Port Admin State.
Global Port Link Status	DINT (4)	Ports Link Status.

Pre-configured Tags in the Moxa AOI

The Moxa AOI supports all the CIP tags listed in the tables below. But in the AOI, we only pre-configure logic links between selected tags and Moxa switches. To monitor the non-configured tags, PLC programmers need to create the links manually. Otherwise, in RSLogix 5000, the value column of these tags will display as "0". If you experience problems creating new links, please contact Moxa technical support for assistance.



NOTE

For pre-configured tags, Moxa has already created the logic links between the CIP tags and Moxa Ethernet switches so RSLogix 5000 can get/set the switch information correctly.

The table below specifies all the pre-configured tags in Moxa AOI with a ※ mark.

Pre-Configured Tags	Attribute Name
Identity Object (0x01)	
※	Vendor ID
※	Device Type
※	Product Code
※	Revision
※	Status
※	Serial Number

Pre-Configured Tags	Attribute Name
※	Product Name
	Assigned Name
	Geographic Location
Base Switch Object (0x51)	
※	Device Up Time
※	Total Port Count
※	System Firmware Version
※	Power Source
※	Port Mask Size
※	Existing Port
※	Global Port Admin State
※	Global Port Link Status
TCP/IP Interface Object (0xF5)	
※	Status
※	Configuration Capability
※	Configuration Control
※	Physical Link Object
※	Interface Configuration
※	Host Name
※	Encapsulation Inactivity Timeout
Ethernet Link Object (0xF6)	
※	Interface Speed
※	Interface Flags
※	Physical Address
※	Interface Counters
	Media Counters
※	Interface Control
	Interface Label
	Interface Capability
	HC Interface Counters
	HC Media Counters
※	Port State
	Media Type
※	Traffic Storm Control
※	Port On event
※	Port Off event
※	Port shut down by Port Security event
※	Port shut down by Rate Limit event
※	Port recovered by Rate Limit event
※	Fiber Check Warning
Moxa Networking Object (0x404)	
※	CPU Usage
※	L2 Redundancy
※	Relay Alarm Status
	Cold Start
	Warm Start
	Redundant port health check fail
	PD over current
	PD no response
	Power On
	Power Off
	DI on
	DI off
※	Port On
※	Port Off
※	Port shutdown by Port Security

Pre-Configured Tags	Attribute Name
※	Port shutdown by Rate Limit
※	Port recovered by Rate Limit
※	Fiber Check Warning
	Relay Alarm Cut-off
※	Reset MIB Count
※	Reset Device
I/O Message Object (for RKS-G4000 Series, MDS-G4000 Series, and MDS-G4000-4XGS Series only)	
※	Relay Alarm Status
※	Existing Port
※	Global Port Link Status
※	Global Port Admin State
I/O Message Object (for EDS-4000 Series and EDS-G4000 Series only)	
※	Power Source Status
※	Global Link Status
※	Global Admin State

Monitoring AOI Tags

In RSLogix 5000, you can monitor the values of all configured tags by selecting “Monitor Tags” in the controller organizer window. It can also be used to check that the AOI is installed correctly.



NOTE

Only Moxa pre-configured tags will display the correct values. Refer to the **CIP Tags** section above for detailed information.

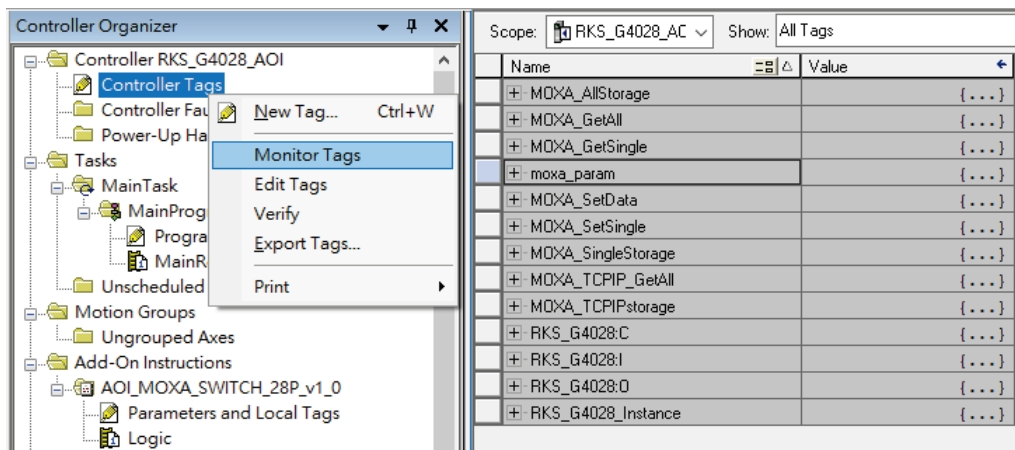

Monitor Tags for Identity Object

Click **moxa_param Switch_Identity** and expand the list to check the values for Identity tags.

Scope: RKS_G4028_AC		Show: All Tags	
Name	Value	Force Mask	Data Type
MOXA_AllStorage	{...}	{...}	SINT[200]
MOXA_GetAll	{...}	{...}	MESSAGE
MOXA_GetSingle	{...}	{...}	MESSAGE
moxa_param	{...}	{...}	MOXA_Switch_Param...
moxa_param.Switch_Input	{...}	{...}	DINT[5]
moxa_param.Switch_Output	{...}	{...}	DINT[2]
moxa_param.Switch_Identity	{...}	{...}	MOXA_Identity_Object
moxa_param.Switch_Identity.Vendor_ID	16#03df		INT
moxa_param.Switch_Identity.Device_Type	16#002c		INT
moxa_param.Switch_Identity.Product_Code	16#2301		INT
moxa_param.Switch_Identity.Major_Revision	1		SINT
moxa_param.Switch_Identity.Minor_Revision	1		SINT
moxa_param.Switch_Identity.Status	16#0060		INT
moxa_param.Switch_Identity.Serial_Number	16#0000_0000		DINT
moxa_param.Switch_Identity.Product_Name	'RKS-G4028-L3-4GT-HV'	{...}	STRING
moxa_param.Switch_Identity.Assigned_Name	''	{...}	MOXA_String_1024
moxa_param.Switch_Identity.Geographic_Location	''	{...}	MOXA_String_1024

Monitor Tags for TCPIP Object

Click **moxa_param Switch_TCPIP** and expand the list to check the values for TCPIP tags.

Scope: RKS_G4028_AC		Show: All Tags	
Name	Value	Force Mask	Data Type
MOXA_AllStorage	{...}	{...}	SINT[200]
MOXA_GetAll	{...}	{...}	MESSAGE
MOXA_GetSingle	{...}	{...}	MESSAGE
moxa_param	{...}	{...}	MOXA_Switch_Param...
moxa_param.Switch_Input	{...}	{...}	DINT[5]
moxa_param.Switch_Output	{...}	{...}	DINT[2]
moxa_param.Switch_Identity	{...}	{...}	MOXA_Identity_Object
moxa_param.Switch_Base_Switch	{...}	{...}	MOXA_Base_Switch...
moxa_param.Switch_TCPIP_Interface	{...}	{...}	MOXA_TCPIP_Interfac...
moxa_param.Switch_TCPIP_Interface.Status	16#0000_0001		DINT
moxa_param.Switch_TCPIP_Interface.Configuration_C...	16#0000_0016		DINT
moxa_param.Switch_TCPIP_Interface.Configuration_C...	16#0000_0000		DINT
moxa_param.Switch_TCPIP_Interface.Path_Size	2		INT
moxa_param.Switch_TCPIP_Interface.Object_Path	16#0124_f620		DINT
moxa_param.Switch_TCPIP_Interface.IP_Address	16#c0a8_7ffd		DINT
moxa_param.Switch_TCPIP_Interface.Network_Mask	16#ffff_ff00		DINT
moxa_param.Switch_TCPIP_Interface.Gateway_Address	16#0000_0000		DINT
moxa_param.Switch_TCPIP_Interface.Name_Server_1	16#0000_0000		DINT
moxa_param.Switch_TCPIP_Interface.Name_Server_2	16#0000_0000		DINT
moxa_param.Switch_TCPIP_Interface.Domain_Name	''	{...}	STRING
moxa_param.Switch_TCPIP_Interface.Host_Name	'moxa'	{...}	STRING
moxa_param.Switch_TCPIP_Interface.Encapsulation_I...	120		INT

Monitor Tags for Ethernet Link Object

Click **moxa_param.Switch_Ethernet_Link** and expand the list to check the values for per port Ethernet Link tags.

Scope: RKS_G4028_AC		Show: All Tags		
Name	Value	Force Mask	Style	Data Type
+ moxa_param.Switch_TCPIP_Interface	{...}	{...}		MOXA_TCPIP_Interfac...
- moxa_param.Switch_Ethernet_Link	{...}	{...}		MOXA_Ethernet_Link_...
+ moxa_param.Switch_Ethernet_Link[0]	{...}	{...}		MOXA_Ethernet_Link_...
- moxa_param.Switch_Ethernet_Link[1]	{...}	{...}		MOXA_Ethernet_Link_...
+ moxa_param.Switch_Ethernet_Link[1].Interface_Spe...	100		Decimal	DINT
+ moxa_param.Switch_Ethernet_Link[1].Interface_Flags	{...}	{...}		MOXA_Interface_Obje...
+ moxa_param.Switch_Ethernet_Link[1].Physical_Addr...	{...}	{...}	Hex	SINT[6]
+ moxa_param.Switch_Ethernet_Link[1].InOctets	221020		Decimal	DINT
+ moxa_param.Switch_Ethernet_Link[1].InUcastPackets	1242		Decimal	DINT
+ moxa_param.Switch_Ethernet_Link[1].InNucastPack...	139		Decimal	DINT
+ moxa_param.Switch_Ethernet_Link[1].InDiscards	0		Decimal	DINT
+ moxa_param.Switch_Ethernet_Link[1].InErrors	0		Decimal	DINT
+ moxa_param.Switch_Ethernet_Link[1].InUnknownPr...	0		Decimal	DINT
+ moxa_param.Switch_Ethernet_Link[1].OutOctets	174210		Decimal	DINT
+ moxa_param.Switch_Ethernet_Link[1].OutUcastPac...	1268		Decimal	DINT
+ moxa_param.Switch_Ethernet_Link[1].OutNucastPa...	58		Decimal	DINT
+ moxa_param.Switch_Ethernet_Link[1].OutDiscards	0		Decimal	DINT
+ moxa_param.Switch_Ethernet_Link[1].OutErrors	0		Decimal	DINT
+ moxa_param.Switch_Ethernet_Link[1].Alignment_Err...	0		Decimal	DINT
+ moxa_param.Switch_Ethernet_Link[1].FCS_Errors	0		Decimal	DINT
+ moxa_param.Switch_Ethernet_Link[1].Single_Collisions	0		Decimal	DINT
+ moxa_param.Switch_Ethernet_Link[1].Multiple_Collisi...	0		Decimal	DINT
+ moxa_param.Switch_Ethernet_Link[1].SQE_Test_Err...	0		Decimal	DINT
+ moxa_param.Switch_Ethernet_Link[1].Deferred_Tra...	0		Decimal	DINT
+ moxa_param.Switch_Ethernet_Link[1].Late_Collisions	0		Decimal	DINT
+ moxa_param.Switch_Ethernet_Link[1].Excessive_Co...	0		Decimal	DINT
+ moxa_param.Switch_Ethernet_Link[1].MAC_Transmi...	0		Decimal	DINT
+ moxa_param.Switch_Ethernet_Link[1].Carrier_Sense...	0		Decimal	DINT
+ moxa_param.Switch_Ethernet_Link[1].Frame_Too_L...	0		Decimal	DINT
+ moxa_param.Switch_Ethernet_Link[1].MAC_Receiv...	0		Decimal	DINT
+ moxa_param.Switch_Ethernet_Link[1].Control_Bits	1		Decimal	INT
+ moxa_param.Switch_Ethernet_Link[1].Forced_Interf...	0		Decimal	INT
+ moxa_param.Switch_Ethernet_Link[1].Interface_Label	''	{...}		STRING
+ moxa_param.Switch_Ethernet_Link[1].Capability_Bits	0		Decimal	DINT
+ moxa_param.Switch_Ethernet_Link[1].Speed_Duple...	0		Decimal	SINT
+ moxa_param.Switch_Ethernet_Link[1].Interface_Spe...	{...}	{...}		MOXA_Interface_Capa...
- moxa_param.Switch_Ethernet_Link[1].HC_InOctets	0		Decimal	LINT
- moxa_param.Switch_Ethernet_Link[1].HC_InUcastP...	0		Decimal	LINT
- moxa_param.Switch_Ethernet_Link[1].HC_InMultica...	0		Decimal	LINT
- moxa_param.Switch_Ethernet_Link[1].HC_InBroadc...	0		Decimal	LINT
- moxa_param.Switch_Ethernet_Link[1].HC_OutOctets	0		Decimal	LINT
- moxa_param.Switch_Ethernet_Link[1].HC_OutUcast...	0		Decimal	LINT
- moxa_param.Switch_Ethernet_Link[1].HC_OutMultic...	0		Decimal	LINT
- moxa_param.Switch_Ethernet_Link[1].HC_OutBroad...	0		Decimal	LINT
- moxa_param.Switch_Ethernet_Link[1].HC_StatsAlign...	0		Decimal	LINT
- moxa_param.Switch_Ethernet_Link[1].HC_StatsFCS...	0		Decimal	LINT
- moxa_param.Switch_Ethernet_Link[1].HC_StatsInter...	0		Decimal	LINT
- moxa_param.Switch_Ethernet_Link[1].HC_StatsFram...	0		Decimal	LINT
- moxa_param.Switch_Ethernet_Link[1].HC_StatsInter...	0		Decimal	LINT
- moxa_param.Switch_Ethernet_Link[1].HC_StatsSym...	0		Decimal	LINT
+ moxa_param.Switch_Ethernet_Link[1].Port_State	5		Decimal	SINT
+ moxa_param.Switch_Ethernet_Link[1].Media_Type	''	{...}		STRING
+ moxa_param.Switch_Ethernet_Link[1].Traffic_Storm...	1		Decimal	SINT
+ moxa_param.Switch_Ethernet_Link[1].Port_On_Event	1		Decimal	SINT
+ moxa_param.Switch_Ethernet_Link[1].Port_Off_Event	1		Decimal	SINT
+ moxa_param.Switch_Ethernet_Link[1].Port_Shutdown...	1		Decimal	SINT
+ moxa_param.Switch_Ethernet_Link[1].Port_Shutdown...	1		Decimal	SINT
+ moxa_param.Switch_Ethernet_Link[1].Port_Recover...	1		Decimal	SINT
+ moxa_param.Switch_Ethernet_Link[1].Fiber_Check_...	1		Decimal	SINT

Monitor Tags for Moxa Networking Object

Click **moxa_param Switch_Moxa_Networking** and expand the list to check the values for Moxa custom tags.

Scope: RKS_G4028_AC		Show: All Tags		
Name	Value	Force Mask	Style	Data Type
+ MOXA_AllStorage	{...}	{...}	Decimal	SINT[200]
+ MOXA_GetAll	{...}	{...}		MESSAGE
+ MOXA_GetSingle	{...}	{...}		MESSAGE
- moxa_param	{...}	{...}		MOXA_Switch_Param...
+ moxa_param.Switch_Input	{...}	{...}	Hex	DINT[5]
+ moxa_param.Switch_Output	{...}	{...}	Hex	DINT[2]
+ moxa_param.Switch_Identity	{...}	{...}		MOXA_Identity_Object
+ moxa_param.Switch_Base_Switch	{...}	{...}		MOXA_Base_Switch_...
+ moxa_param.Switch_TCPIP_Interface	{...}	{...}		MOXA_TCPIP_Interfac...
+ moxa_param.Switch_Ethernet_Link	{...}	{...}		MOXA_Ethernet_Link_...
- moxa_param.Switch_Moxa_Networking	{...}	{...}		MOXA_Networking_O...
+ moxa_param.Switch_Moxa_Networking.CPU_Usage	6		Decimal	SINT
+ moxa_param.Switch_Moxa_Networking.L2_Redundancy	0		Decimal	SINT
+ moxa_param.Switch_Moxa_Networking.Relay_Alarm_S...	0		Decimal	SINT
+ moxa_param.Switch_Moxa_Networking.Cold_Start	0		Decimal	SINT
+ moxa_param.Switch_Moxa_Networking.Warm_Start	0		Decimal	SINT
+ moxa_param.Switch_Moxa_Networking.Redundant_Po...	0		Decimal	SINT
+ moxa_param.Switch_Moxa_Networking.PD_Over_Curr...	0		Decimal	SINT
+ moxa_param.Switch_Moxa_Networking.PD_No_Respo...	0		Decimal	SINT
+ moxa_param.Switch_Moxa_Networking.Power_On	0		Decimal	SINT
+ moxa_param.Switch_Moxa_Networking.Power_Off	0		Decimal	SINT
+ moxa_param.Switch_Moxa_Networking.DI_On	0		Decimal	SINT
+ moxa_param.Switch_Moxa_Networking.DI_Off	0		Decimal	SINT
+ moxa_param.Switch_Moxa_Networking.Port_On	1		Decimal	SINT
+ moxa_param.Switch_Moxa_Networking.Port_Off	1		Decimal	SINT
+ moxa_param.Switch_Moxa_Networking.Port_Shutdown...	1		Decimal	SINT
+ moxa_param.Switch_Moxa_Networking.Port_Shutdown...	1		Decimal	SINT
+ moxa_param.Switch_Moxa_Networking.Port_Recover...	1		Decimal	SINT
+ moxa_param.Switch_Moxa_Networking.Fiber_Check_...	1		Decimal	SINT
+ moxa_param.Switch_Moxa_Networking.Relay_Alarm_C...	0		Decimal	SINT
+ moxa_param.Switch_Moxa_Networking.Reset_Mib_Co...	0		Decimal	SINT
+ moxa_param.Switch_Moxa_Networking.Reset_Device	0		Decimal	SINT

Monitor Tags for Moxa Base Switch Object

Click **moxa_param Switch_Base_Switch** and expand the list to check the values for Moxa custom tags.

Scope: RKS_G4028_AC		Show: All Tags	
Name	Value	Force Mask	Data Type
+ MOXA_AllStorage	{...}	{...}	SINT[200]
+ MOXA_GetAll	{...}	{...}	MESSAGE
+ MOXA_GetSingle	{...}	{...}	MESSAGE
- moxa_param	{...}	{...}	MOXA_Switch_Param...
+ moxa_param.Switch_Input	{...}	{...}	DINT[5]
+ moxa_param.Switch_Output	{...}	{...}	DINT[2]
+ moxa_param.Switch_Identity	{...}	{...}	MOXA_Identity_Object
- moxa_param.Switch_Base_Switch	{...}	{...}	MOXA_Base_Switch_...
+ moxa_param.Switch_Base_Switch.Device_Up_Time	5940		DINT
+ moxa_param.Switch_Base_Switch.Total_Port_Count	28		DINT
+ moxa_param.Switch_Base_Switch.System_Firmware_V...	'v4.0 Build 2023_0505_1550'	{...}	STRING
+ moxa_param.Switch_Base_Switch.Power_Source	3		INT
+ moxa_param.Switch_Base_Switch.Port_Mask_Size	4		INT
- moxa_param.Switch_Base_Switch.Existing_Port	{...}	{...}	DINT[4]
+ moxa_param.Switch_Base_Switch.Existing_Port[0]	16#0ff0_000f		DINT
+ moxa_param.Switch_Base_Switch.Existing_Port[1]	16#0000_0000		DINT
+ moxa_param.Switch_Base_Switch.Existing_Port[2]	16#0000_0000		DINT
+ moxa_param.Switch_Base_Switch.Existing_Port[3]	16#0000_0000		DINT
- moxa_param.Switch_Base_Switch.Global_Port_Admin...	{...}	{...}	DINT[4]
+ moxa_param.Switch_Base_Switch.Global_Port_Admin...	16#0ff0_000f		DINT
+ moxa_param.Switch_Base_Switch.Global_Port_Admin...	16#0000_0000		DINT
+ moxa_param.Switch_Base_Switch.Global_Port_Admin...	16#0000_0000		DINT
+ moxa_param.Switch_Base_Switch.Global_Port_Admin...	16#0000_0000		DINT
- moxa_param.Switch_Base_Switch.Global_Port_Link_St...	{...}	{...}	DINT[4]
+ moxa_param.Switch_Base_Switch.Global_Port_Link...	16#0800_0000		DINT
+ moxa_param.Switch_Base_Switch.Global_Port_Link...	16#0000_0000		DINT
+ moxa_param.Switch_Base_Switch.Global_Port_Link...	16#0000_0000		DINT
+ moxa_param.Switch_Base_Switch.Global_Port_Link...	16#0000_0000		DINT

G. Product Code Table for Industrial Protocols

Product Code (16 Bits)	Product Code (32 Bits)	Product Name
0x1081	0x11010001	MDS-G4012
0x1082	0x11010002	MDS-G4020
0x1083	0x11010003	MDS-G4028
0x2081	0x12010001	MDS-G4012-L3
0x2082	0x12010002	MDS-G4020-L3
0x2083	0x12010003	MDS-G4028-L3
0x1281	0x11050001	MDS-G4012-4XGS-T
0x1282	0x11050002	MDS-G4020-4XGS-T
0x1283	0x11050003	MDS-G4028-4XGS-T
0x2281	0x12050001	MDS-G4012-L3-4XGS-T
0x2282	0x12050002	MDS-G4020-L3-4XGS-T
0x2283	0x12050003	MDS-G4028-L3-4XGS-T
0x1301	0x11060001	RKS-G4028-4GT-HV-T
0x1302	0x11060002	RKS-G4028-4GT-2HV-T
0x1303	0x11060003	RKS-G4028-4GS-HV-T
0x1304	0x11060004	RKS-G4028-4GS-2HV-T
0x1305	0x11060005	RKS-G4028-4GT-LV-T
0x1306	0x11060006	RKS-G4028-4GT-2LV-T
0x1307	0x11060007	RKS-G4028-4GS-LV-T
0x1308	0x11060008	RKS-G4028-4GS-2LV-T
0x1309	0x11060009	RKS-G4028-PoE-4GS-HV-T
0x130A	0x1106000A	RKS-G4028-PoE-4GS-2HV-T
0x130B	0x1106000B	RKS-G4028-PoE-4GS-LV-T
0x130C	0x1106000C	RKS-G4028-PoE-4GS-2LV-T
0x2301	0x12060001	RKS-G4028-L3-4GT-HV-T
0x2302	0x12060002	RKS-G4028-L3-4GT-2HV-T
0x2303	0x12060003	RKS-G4028-L3-4GS-HV-T
0x2304	0x12060004	RKS-G4028-L3-4GS-2HV-T
0x2305	0x12060005	RKS-G4028-L3-4GT-LV-T
0x2306	0x12060006	RKS-G4028-L3-4GT-2LV-T
0x2307	0x12060007	RKS-G4028-L3-4GS-LV-T
0x2308	0x12060008	RKS-G4028-L3-4GS-2LV-T
0x2309	0x12060009	RKS-G4028-L3-PoE-4GS-HV-T
0x230A	0x1206000A	RKS-G4028-L3-PoE-4GS-2HV-T
0x230B	0x1206000B	RKS-G4028-L3-PoE-4GS-LV-T
0x230C	0x1206000C	RKS-G4028-L3-PoE-4GS-2LV-T
0x1100	0x11021000	EDS-4008
0x1101	0x11021001	EDS-4008-2MSC
0x1102	0x11021002	EDS-4008-2MST
0x1103	0x11021003	EDS-4008-2SSC
0x1104	0x11021004	EDS-4008-2GT-2GS
0x1105	0x11024005	EDS-4008-4P-2GT-GS
0x1106	0x11021806	EDS-G4008
0x1107	0x11022007	EDS-4009-3MSC
0x1108	0x11022008	EDS-4009-3MST
0x1109	0x11022009	EDS-4009-3SSC
0x110A	0x1102300a	EDS-4012-4GS
0x110B	0x1102300b	EDS-4012-4GC

Product Code (16 Bits)	Product Code (32 Bits)	Product Name
0x110C	0X1102300c	EDS-4012-4GS-HV-T
0x110D	0X1102300d	EDS-4012-4GC-HV-T
0x110E	0x1102340e	EDS-4012-8P-4GS
0x110F	0x1102380f	EDS-G4012-4GC
0x1110	0x11023c10	EDS-G4012-8P-4GS
0x1111	0x11024011	EDS-G4014-4GS-2QGS
0x1112	0x11024012	EDS-4014-4GS-2QGS-HV-T
0x1113	0x11024813	EDS-G4014-6QGS
0x1114	0x11024814	EDS-G4014-4QGS-2XGS

H. Security Guidelines

This appendix explains security practices for installing, operating, maintaining, and decommissioning the device. Moxa strongly recommends that our customers follow these guidelines to enhance network and equipment security.

Installation

Physical Installation

1. The device **MUST** be installed in an access controlled area, where only the necessary personnel have physical access to the device.
2. The device **MUST NOT** be directly connected to the Internet, which means switches **MUST** be installed within a security perimeter, which can be implemented by a firewall at the border since the device is not classified as zone/boundary equipment.
3. Please follow the instructions in the Quick Installation Guide, which is included in the package, to ensure you install the device correctly in your environment.
4. The device has anti-tamper labels on the enclosures. This allows an administrator to tell whether the device has been tampered with.
5. The ports that are not in use should be deactivated. Please refer to **[User Manual section Port Interface]** for detailed instructions.

Account Management

Follow these best practices when setting up an account.

1. Each account should be assigned the correct privileges: Only allow the minimum number of people to have admin privilege so they can perform device configuration or modifications, while other users should only have read access privilege. The device supports both local account authentication and remote centralized mechanism, including Radius and TACACS+.
2. Change the default password, and strengthen the account password complexity by:
 - a. Enabling the "Password Policy" function.
 - b. Increasing the minimum password length to at least eight characters.
 - c. Defining a password policy to ensure that it contains at least an uppercase and lowercase letter, a digit, and a special character.
 - d. Setting user passwords to expire after a certain period of time.
3. Enforce regulations that ensure that only a trusted host can access the device. Please refer to **Trusted Access** for detailed instructions.

Vulnerable Network Ports

1. For network security concerns, we strongly recommend that you change the port numbers, such as TCP port numbers for HTTP, HTTPS, Telnet, and SSH, for the protocols that are in use; ports that are not in use but are still reachable pose an unacceptable security risk and should be disabled. Refer to the **Management Interface** section for detailed instructions.
2. In order to avoid eavesdroppers from snooping confidential information, users should adopt encryption-based communication protocols, such as HTTPS instead of HTTP, SSH instead of Telnet, SFTP instead of TFTP, SNMPv3 instead of SNMPv1/v2c, etc. In addition, the maximum number of sessions should be kept to an absolute minimum. Please refer to **Management Interface** for detailed instructions.
3. Users should re-generate SSL certificate and SSH key for the device before commissioning HTTPS or SSH applications. Please refer to **SSH & SSL** for detailed instructions.

Operation

1. In order to ensure that communications are properly protected, use a strong cryptographic algorithm for key exchange or encryption protocols for HTTPS/SSH applications. The device follows the NIST SP800-52 and SP800-131 standards, and supports TLS v1.2 and v1.3 with the following cipher suites:

TLS V1.2				
Cipher suite name	Key exchange	Authentication	Encryption	Hash function
TLS_ECDHE_RSA_WITH_CHACHA20_POLY1305_SHA256	ECDHE	RSA	CHACHA20-POLY1305	SHA256
TLS_ECDHE_ECDSA_WITH_AES_128_GCM_SHA256	ECDHE	ECDSA	AES128	SHA256
TLS_ECDHE_RSA_WITH_AES_128_GCM_SHA256	ECDHE	RSA	AES128	SHA256
TLS_ECDHE_RSA_WITH_AES_256_GCM_SHA384	ECDHE	RSA	AES256	SHA384
TLS_DHE_RSA_WITH_AES_128_GCM_SHA256	Ephemeral DH	RSA	AES128	SHA256
TLS_DHE_RSA_WITH_AES_256_GCM_SHA384	Ephemeral DH	RSA	AES256	SHA384
TLS_DHE_RSA_WITH_CHACHA20_POLY1305_SHA256	Ephemeral DH	RSA	CHACHA20-POLY1305	SHA256
TLS_ECDHE-RSA_WITH_AES256-SHA384	ECDHE	RSA	AES256	SHA384
TLS_ECDHE_RSA_WITH_AES_128_CBC_SHA256	ECDHE	RSA	AES128	SHA256
TLS_ECDHE_ECDSA_WITH_CHACHA20_POLY1305_SHA256	ECDHE	ECDSA	CHACHA20-POLY1305	SHA256
TLS_ECDHE_RSA_WITH_AES_256_CBC_SHA384	ECDHE	RSA	AES256	SHA384
TLS_ECDHE_ECDSA_WITH_AES_256_CBC_SHA384	ECDHE	ECDSA	AES256	SHA384
TLS_ECDHE_ECDSA_WITH_AES_128_CBC_SHA256	ECDHE	ECDSA	AES128	SHA256

TLS V1.3				
Cipher suite name	Key exchange	Encryption	Mode	Hash function
TLS_AES_256_GCM_SHA384	any	AES256	GCM	SHA384
TLS_CHACHA20_POLY1305_SHA256	any	CHACHA20-POLY1305	N/A	SHA256
TLS_AES_128_GCM_SHA256	any	AES128	GCM	SHA256

2. Below is a list of the recommended secure browsers that support TLS v1.2 or above:

Browser	Version
Microsoft Edge	All
Microsoft Internet Explorer	v11 or above
Mozilla Firefox	v27 or above
Google Chrome	v38 or above
Apple Safari	v7 or above

Reference: <https://support.globalsign.com/ssl/general-ssl/tls-protocol-compatibility#Browsers>

3. The device supports event logs and syslog for SIEM integration:
- Event log: Due to limited storage capacity, the event log can only accommodate a maximum of 10,000 entries. Administrators can set a warning for a pre-defined threshold. We recommend that users regularly back up system event logs. Please refer to **Event Log** for detailed instructions.
 - Syslog: the device supports syslog, and advanced secure TLS-based syslog for centralized SIEM integration. Please refer to **Syslog Settings** for detailed instructions.
4. The device can provide information for control system inventory:
- SNMPv1, v2c, v3: We recommend administrators use SNMPv3 with authentication and encryption to manage the network. Please refer to the **MIB** file for detailed instructions.
 - Telnet/SSH: We recommend that administrators use SSH with authentication and encryption to retrieve device properties.
 - HTTP/HTTPS: We recommend that administrators use HTTPS with a certificate that has been granted by a Certificate Authority to configure the device.
 - MMS: We recommend administrators enable MMS security mode to enhance protection.
5. Denial of Service protection: To avoid disruption of normal operation of the switch, administrators should configure the QoS function. The device supports ingress rate limit and egress shaper. Administrators can decide how to deal with excess data flow and configure the device accordingly. This process will regulate the resulted data rate per port. Please refer to **QoS** for detailed instructions.
6. Time synchronization with authentication: Time synchronization is crucial for process control. To prevent malicious attacks whereby the settings are changed without permission, authentication must be in place between the NTP server and client. The device supports NTP with a pre-shared key. Please refer to **NTP** for detailed instructions.
7. Periodically regenerate the SSH and SSL certificates: Even though the device supports RSA 2048-bit and SHA-256 to ensure sufficient complexity, we strongly recommend that users frequently renew their SSH key and SSL certificate in case the key is compromised. Please refer to **SSH & SSL** for detailed instructions.
8. Below is the list of the protocol port numbers used for all external interfaces.

Protocol: TCP

Service Type	Port Number
SSH	22
Telnet	23
HTTP	80
HTTPS	443

Protocol: UDP

Service Type	Port Number
DHCP	67
NTP	123
SNMP	161
Moxa Service	40404

Maintenance

1. Perform firmware upgrades frequently to enhance features, deploy security patches, or fix bugs.
2. Frequently back up the system configurations: In order to properly protect the system configuration files from being tampered with, the device supports password encryption and signature authentication for backup files.
3. Examine event logs frequently to detect any anomalies.
4. To report vulnerabilities of Moxa products, please submit your findings on the following web page: <https://www.moxa.com/en/support/product-support/security-advisory/report-a-vulnerability>.

Decommission

To avoid disclosing sensitive information such as account password and certificate, please reset the system settings to factory default before decommissioning the device or sending it back to Moxa RMA service.